



Type VDFR flow control pressure compensated valves

- Flow divider combiners

Technical specifications and diagrams are measured with mineral oil of 46 cSt viscosity at 40°C (104°F) temperature.

	VDFR 38-12	VDFR 38-24	VDFR 38-40	VDFR 12-12	VDFR 12-24	VDFR 12-40	VDFR 34-65	VDFR 34-90	VDFR 100-150	VDFR 114-250	
Nominal flow	l/min 4÷12 US gpm 1.1÷3.2	12÷24 3.2÷6.3	24÷38 6.3÷10.04	6.5÷12 1.71÷3.2	13÷23 3.43÷6.07	24÷40 6.3÷10.6	34÷65 8.98÷17.17	40÷90 10.6÷23.8	90÷150 23.8÷39.6	200÷250 52.8÷66	
Max. pressure	Aluminium body = 210 bar (3050 psi) Steel body = 350 bar (5100 psi)									Steel body = 350 bar (5100 psi)	
Maximum division error	± 5% of the oil flow in U1 or U2 and 120 bar (1750 psi) pressure difference between U1 and U2. (Division rate 50%÷50%)										
Fluid	mineral based oil										
Viscosity	from 10 to 200 cSt										
Max. level of contamination	18/16/13 ISO4406										
Fluid temperature	with NBR seals from -20°C (-4°F) to 80°C (176°F)										
Environmental temp. for working conditions	from -40°C (-40°F) to 100°C (212°F)										
Weight	alum.	0.82 kg (1.81 lb)	0.82 kg (1.81 lb)	0.87 kg (1.92 lb)	0.83 kg (1.83 lb)	0.83 kg (1.83 lb)	0.82 kg (1.81 lb)	0.92 kg (2.03 lb)	2.16 kg (4.76 lb)	2.09 kg (4.61 lb)	-
	steel	1.98 kg (4.37 lb)	1.98 kg (4.37 lb)	-	-	-	1.97 kg (4.34 lb)	-	4.42 kg (9.74 lb)	4.29 kg (9.46 lb)	6.58 kg (14.51 lb)

NOTE - For different conditions, please contact Walvoil Sales Dpt.

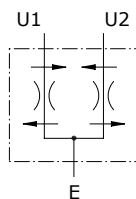

Dimensions

VDFR 38-12 - VDFR 38-24 - VDFR 12-40

These valves are supplied, as standard, without mounting holes.
Configurations with mounting holes (see dimension Q) are on request.

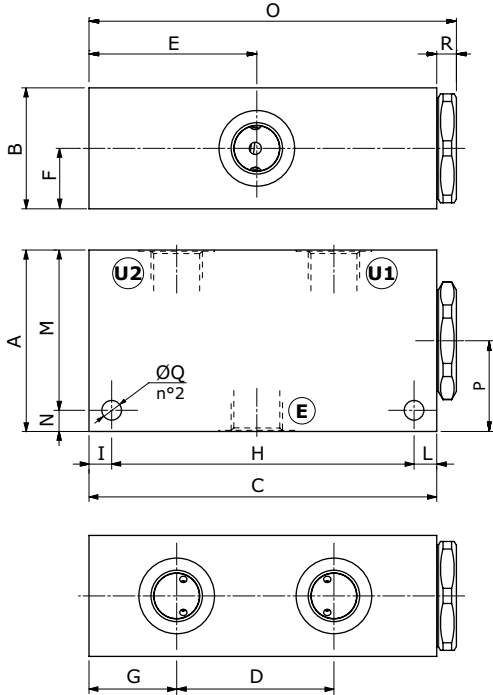

VDFR 34-65 - VDFR 34-90 - VDFR 100-150

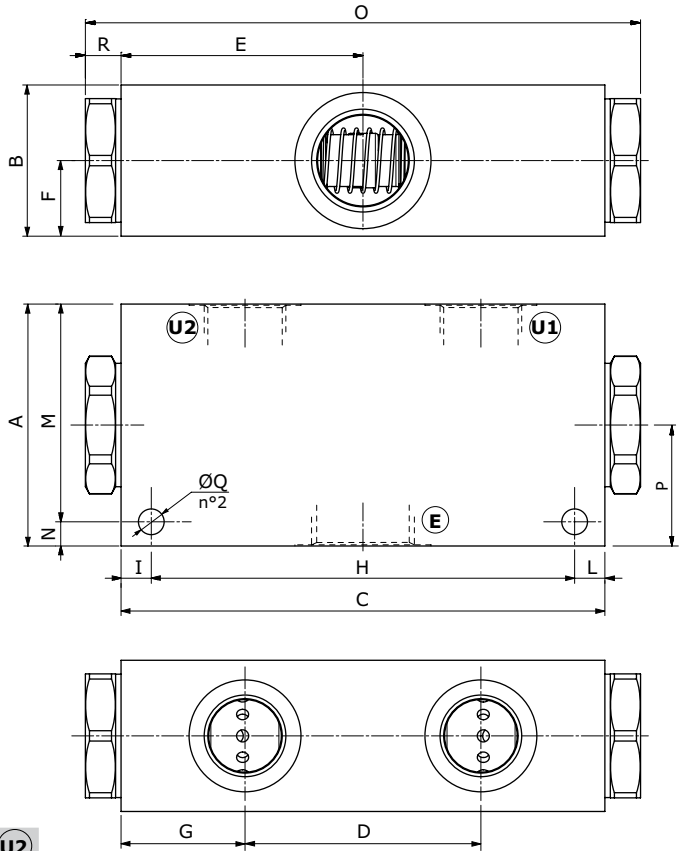

Valve type	E	U1 - U2	Valve type	E	U1 - U2
VDFR 38-12	G3/8	G3/8	VDFR 12-40	G1/2	G3/8
VDFR 38-24	G3/8	G3/8	VDFR 34-65	G3/4	G1/2
VDFR 38-40	G3/8	G3/8	VDFR 34-90	G3/4	G1/2
VDFR 12-12	G1/2	G3/8	VDFR 100-150	G1"	G3/4
VDFR 12-24	G1/2	G3/8	VDFR 114-250	G1"1/4	G1"

Valve type	E	U1 - U2
VDFR 38-12/SAE	SAE8	SAE8
VDFR 38-24/SAE	SAE8	SAE8
VDFR 12-40/SAE	SAE10	SAE8
VDFR 34-90/SAE	SAE12	SAE10
VDFR 100-150/SAE	SAE16	SAE12

VDFR 114-250

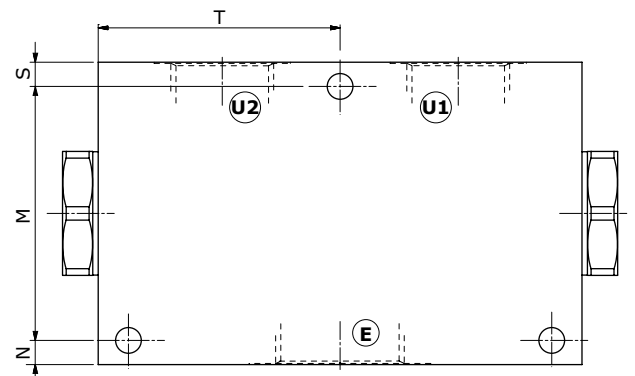

Dimensions are in mm-in

Valve type	A	B	C	D	E	F	G	H	I	L	M	N	O	P	ØQ	R	S	T
VDFR 38-12	60	40	115	52	55.5	20	29	100	7.5	7.5	53	7	121.5	30	6.5	6.5	-	-
VDFR 38-12/SAE	2.36	1.57	4.53	2.05	2.19	0.79	1.14	3.94	0.295	0.295	2.09	0.276	4.78	1.18	0.256	0.256	-	-
VDFR 38-24/38-40	60	40	115	52	55.5	20	29	100	7.5	7.5	53	7	121.5	30	6.5	6.5	-	-
VDFR 38-24/SAE	2.36	1.57	4.53	2.05	2.19	0.79	1.14	3.94	0.295	0.295	2.09	0.276	4.78	1.18	0.256	0.256	-	-
VDFR 12-12/12-24/12-40	60	40	115	52	55.5	20	29	100	7.5	7.5	53	7	121.5	30	6.5	6.5	-	-
VDFR 12-40/SAE	2.36	1.57	4.53	2.05	2.19	0.79	1.14	3.94	0.295	0.295	2.09	0.276	4.78	1.18	0.256	0.256	-	-
VDFR 34-65/34-90	80	50	160	78	80	25	41	140	10	10	72	8	183.6	40	8.5	11.8	-	-
VDFR 34-90/SAE	3.15	1.97	6.30	3.07	3.15	0.98	1.61	5.51	0.394	0.394	2.83	0.315	7.23	1.57	0.335	0.46	-	-
VDFR 100-150	80	50	160	78	80	25	41	140	10	10	72	8	183.6	40	8.5	11.8	-	-
VDFR 100-150/SAE	3.15	1.97	6.30	3.07	3.15	0.98	1.61	5.51	0.394	0.394	2.83	0.315	7.23	1.57	0.335	0.46	-	-
VDFR 114-250	100	60	160	78	80	30	41	140	10	10	84	8	183.6	50	8.5	11.8	8	80
	3.94	2.36	6.30	3.07	3.15	1.18	1.61	5.51	0.394	0.394	3.31	0.315	7.23	1.97	0.335	0.46	0.315	3.15

Flow control valves

Flow control pressure compensated valves

Ordering codes and description composition

Port size
VDFR 38-12

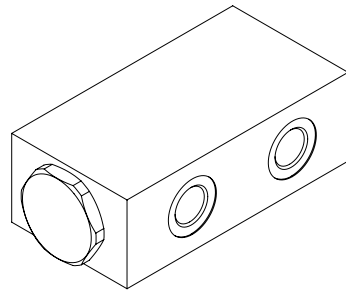

VDFR complete valves

50%-50% Divide ratio

TYPE	CODE	DESCRIPTION
VDFR 38-12	1650021100	Aluminium body, G3/8 ports
VDFR 38-24	1650021101	Aluminium body, G3/8 ports
VDFR 38-40	1650021137	Aluminium body, G3/8 ports
VDFR 12-12	1650031119	Aluminium body, G1/2 ports
VDFR 12-24	1650031120	Aluminium body, G1/2 ports
VDFR 12-40	1650031100	Aluminium body, G1/2 ports
VDFR 34-65	1650041107	Aluminium body, G3/4 ports
VDFR 34-90	1650041100	Aluminium body, G3/4 ports
VDFR 100-150	1650051100	Aluminium body, G1" ports
VDFR 38-12/ac	1650022100	Steel body, G3/8 ports
VDFR 38-24/ac	1650022101	Steel body, G3/8 ports

VDFR complete valves (continue)

50%-50% Divide ratio

TYPE	CODE	DESCRIPTION
VDFR 12-40/ac	1650032100	Steel body, G1/2 ports
VDFR 34-90/ac	1650042101	Steel body, G3/4 ports
VDFR 100-150/ac	1650052100	Steel body, G1" ports
VDFR 114-250/ac	1650062100	Steel body, G1 1/4 ports
VDFR 38-12/SAE	1650021202	Aluminium body, SAE8 ports
VDFR 38-24/SAE	1650021203	Aluminium body, SAE8 ports
VDFR 12-40/SAE	1650031201	Aluminium body, SAE10 ports
VDFR 34-90/SAE	1650041200	Aluminium body, SAE12 ports
VDFR 34-90/SAE/ac	1650042200	Steel body, SAE12 ports
VDFR 100-150/SAE/ac	1650052200	Steel body, SAE16 ports

Note: special divide ratios 33%÷66% - 30%÷70% - 20%÷80% - 25%÷75% - 40%÷60% for VDFR 38-12, 38-24, 12-40 and 34-90. 33%÷66%-40%÷60% for VDFR 100-150

For VDFR 114-250 please contact our Sales Dpt.

Mounting holes on request (standard on VDFR 34-90 - VDFR 100-150 and VDFR114-250)

For other steel body configurations, SAE thread and configurations with FPM (Viton) seals, please contact our Sales Dpt.

Rating diagrams

VDFR 38-12
pressure drop vs. flow
(E→U1-U2) and (U1-U2→E)

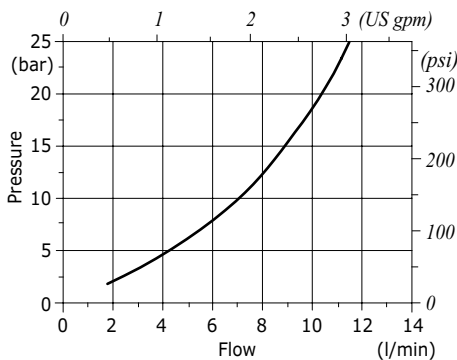

VDFR 38-24
pressure drop vs. flow
(E→U1-U2) and (U1-U2→E)

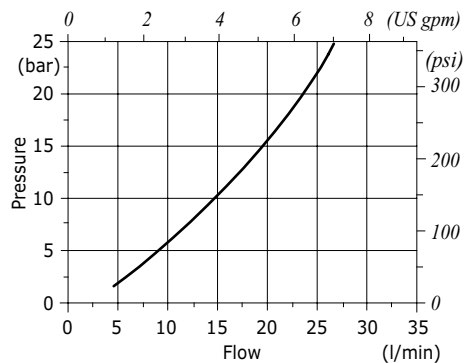

VDFR 38-40
pressure drop vs. flow
(E→U1-U2) and (U1-U2→E)

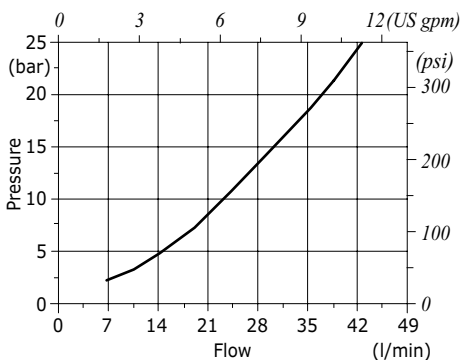

Rating diagrams

VDFR 12-12
pressure drop vs. flow
(E→U1-U2) and (U1-U2→E)

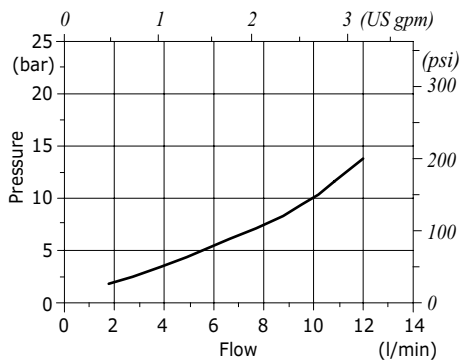

VDFR 12-24
pressure drop vs. flow
(E→U1-U2) and (U1-U2→E)

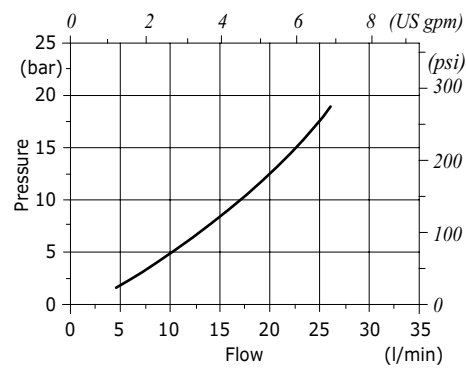

VDFR 12-40
pressure drop vs. flow
(E→U1-U2) and (U1-U2→E)

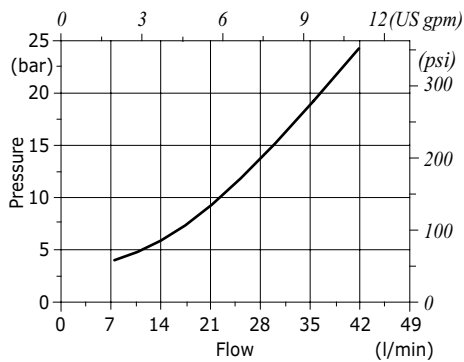

VDFR 34-65
pressure drop vs. flow
(E→U1-U2) and (U1-U2→E)

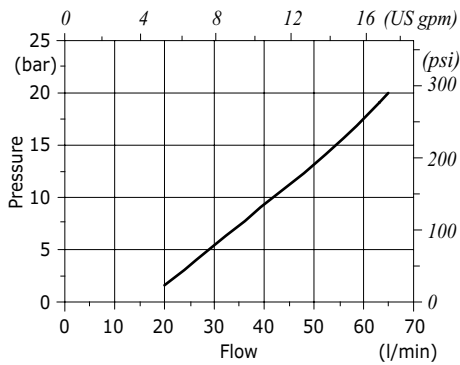

VDFR 34-90
pressure drop vs. flow
(E→U1-U2) and (U1-U2→E)

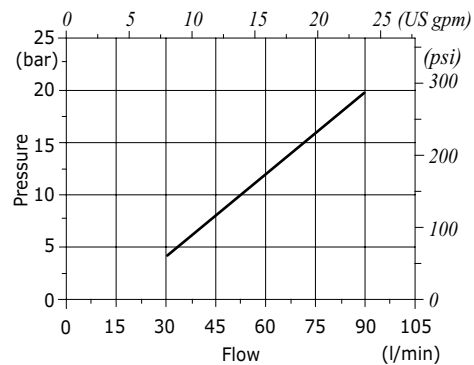

VDFR 100-150
pressure drop vs. flow
(E→U1-U2) and (U1-U2→E)

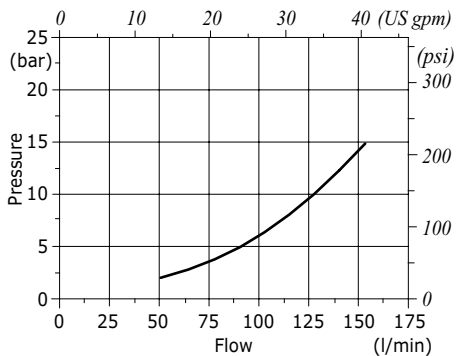

VDFR 114-250
pressure drop vs. flow
(E→U1-U2) and (U1-U2→E)

