

FLOWFIT 12VDC SINGLE ACTING HYDRAULIC POWER PACKS



The Flowfit 12VDC Single Acting power pack is ideal for use in the following applications:

- Tail Lift
- Trailer/Tipper
- Hand operated lift stacker
- Scissor Lift Platform
- Aerial Platform

The Flowfit 12VDC Single Acting power pack is a compact and quiet unit, able to deliver a flow rate of up to 5 litres a minute at 160 bar. The compact design includes a lowering solenoid valve, relief valve and flow controller mounted within the housing and comes complete with a detachable pre-wired 2 button pendant and 4.5 litre plastic tank as standard.

Options available include an 8.0 litre plastic tank for increased capacity on larger systems and a wireless remote, operated by key fob.

The Flowfit 12VDC Single Acting power pack will require a high capacity battery and a suitable in-line fuse for normal operation.

The motor is designed for intermittent use (S3) which is defined as a sequence of identical cycles of 10 minute duration. The cycle comprises a period of on-load (td) operation in which the motor may reach its maximum permitted temperature, followed by an off-load period (tm) of time, insufficient for the motor to return to ambient temperature.

The value of S3 on this motor equates to 7% or 42 seconds of on-load operation in a ten minute period.

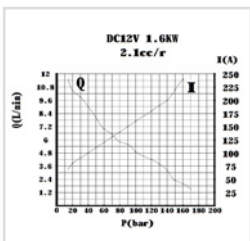
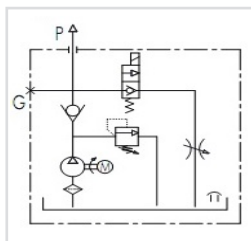

Flowfit 12VDC Single Acting Hydraulic Powerunit

POWERUNIT PACKAGE to operate a single acting cylinder on any trailer or tipper application, or any single acting application complete with detachable two button pendant.

- 12VDC powerunit.
- 2.1cc/rev gear pump.
- 1.6kw 12VDC electric motor c/w relay and plastic motor cover. 4.5 Litre or 8.0 Litre reservoir c/w drain plug.
- Powerpack complete with suction strainer, return oil conveyor and filler breather.
- Horizontal mounting.
- Max pressure 200 bar.
- Relief valve set at 160 bar but adjustable from 40-200 bar as standard.
- Max flow 5 l/min.
- Adjustable flow control for cylinder decent control.
- 12VDC let down valve, relief and P line check.
- Port size 3/8" BSP.
- 2 Button detachable pendant on a 4 metre lead.
- Suitable for all single acting applications.

WITH MANY ADDED FEATURES SUCH AS FLOW CONTROL ON CYLINDER DESCENT, DETACHABLE PENDANTS FOR ADDED SECURITY, REMOVEABLE PLASTIC MOTOR COVER AND A VARIATION ON WHICH RELIEF VALVE SPRING IS FITTED YOU ARE GETTING AN EXCEPTIONALLY GOOD QUALITY PRODUCT AT A VERY COMPETITIVE PRICE.

*Please note. Our DC power units can pull 200 amps at full load, if fusing is a requirement a 210 amp fuse should be used. A minimum 25mm² cable at a max 5 metres in length should be used and negative cable should be in one continuous length from the battery terminating at the power unit.

SINGLE ACTING WIRING DIAGRAM

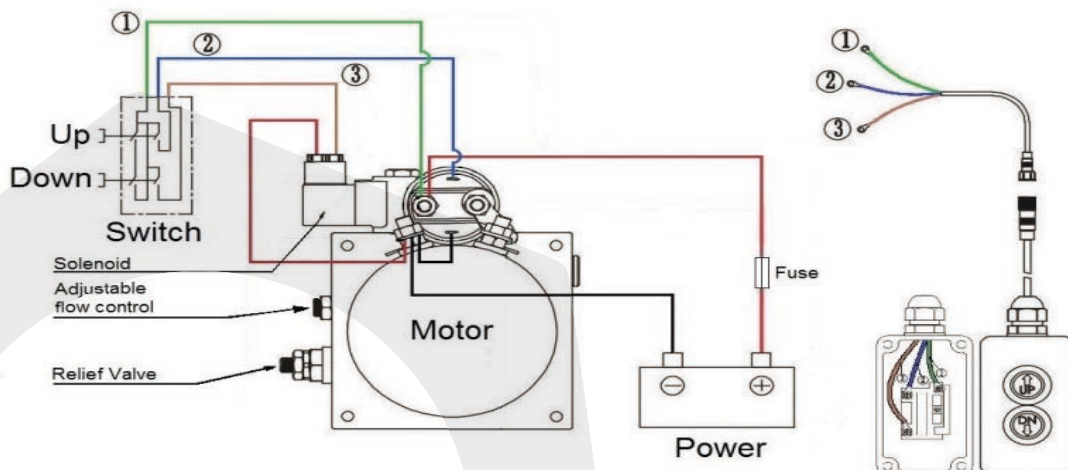

SINGLE ACTING (WITH REMOTE) WIRING DIAGRAM

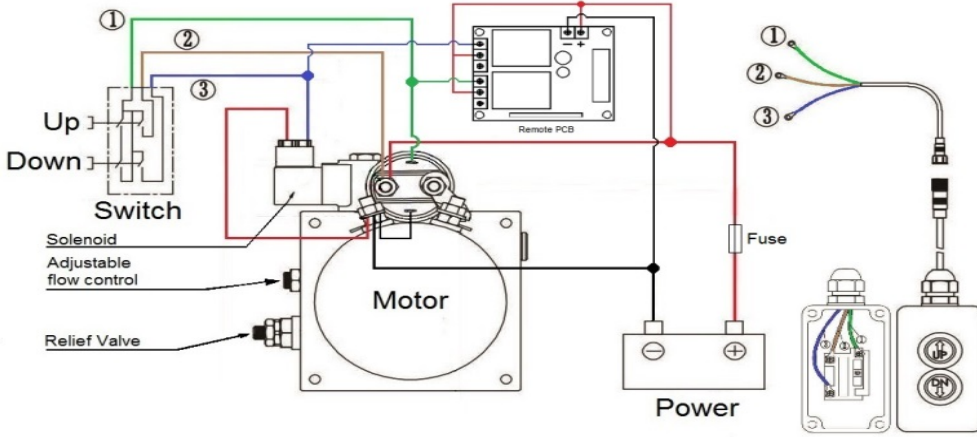

DC SINGLE ACTING POWER PACK DIMENSIONS

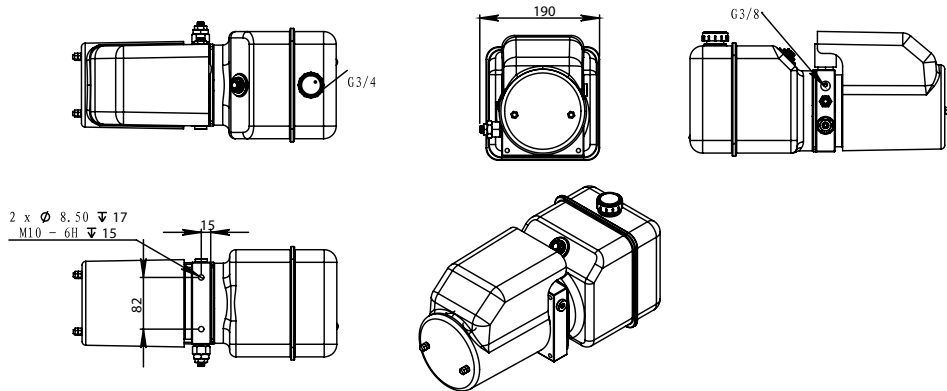

TANK SIZES

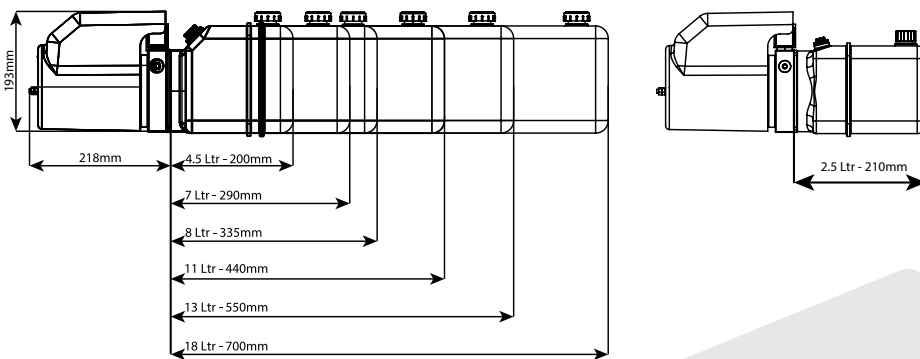

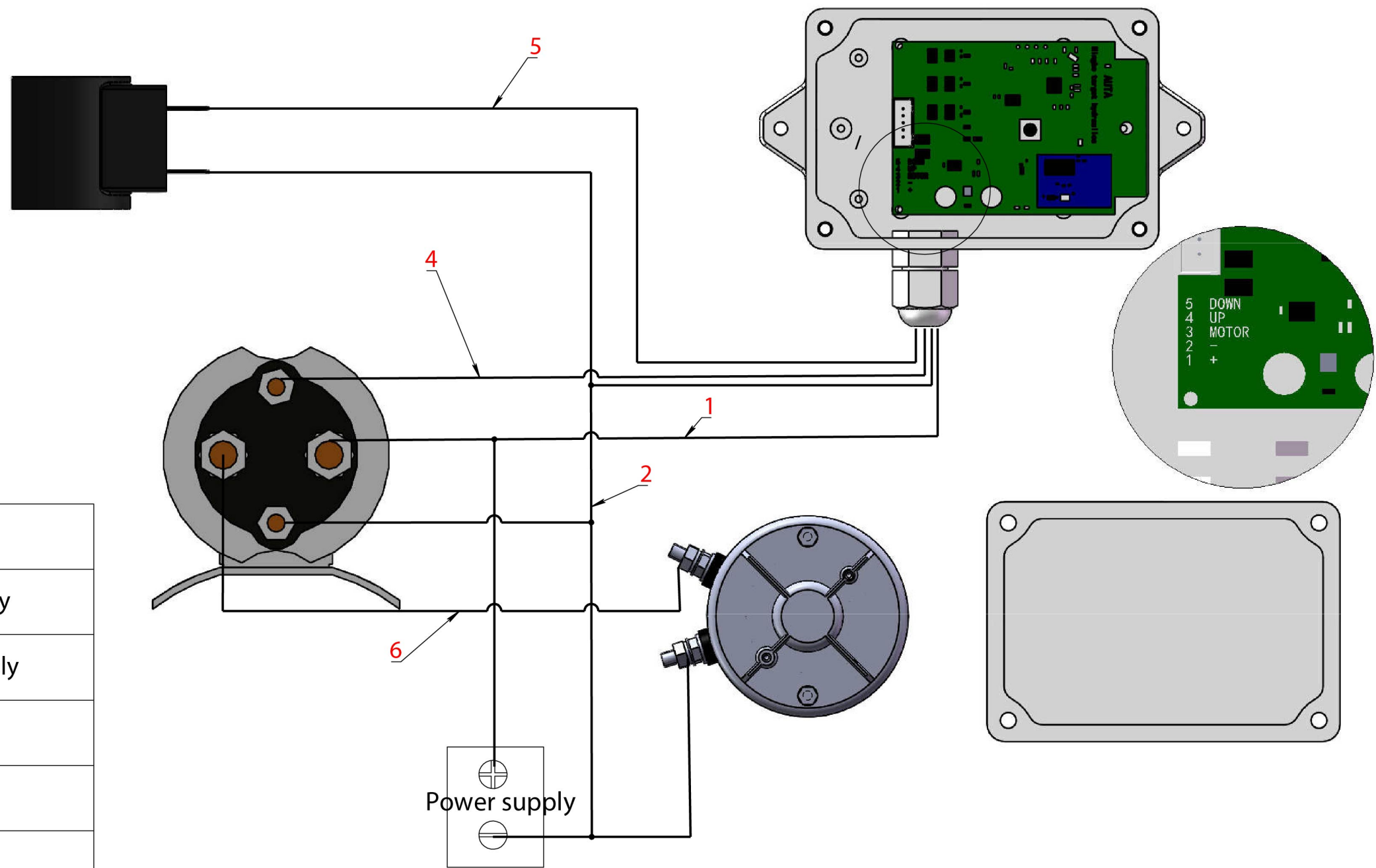

Serial number	Connection mode
1	Positive pole of power supply
2	Negative pole of power supply
3	No
4	Positive pole of start switch
5	Coil positive pole
6	Motor connection line(16FC)