

FLOWFIT®

2021/22
CATALOGUE



MANUFACTURERS AND SUPPLIERS OF
HYDRAULIC COMPONENTS & SYSTEMS

Everything Hydraulic



- HYDRAULIC VALVES
- HYDRAULIC POWER UNITS
- PETROL AND DIESEL POWER PACKS
- HYDRAULIC MOTORS
- GEAR PUMPS
- BELL HOUSINGS & DRIVE COUPLINGS
- ELECTRIC MOTORS
- HYDRAULIC CYLINDERS
- LOG SPLITTER KITS
- CLUTCHES AND GEARBOXES
- HYDRAULIC TANKS
- HYDRAULIC HOSE CRIMPING MACHINES
- HYDRAULIC FILTERS
- FLUID TRANSFER
- QUICK RELEASE COUPLINGS
- HYDRAULIC ADAPTORS
- HYDRAULIC HOSE & FITTINGS
- HYDRAULIC COMPONENTS
- PRESSURE GAUGES



**HYDRAULIC FILTRATION
48 PAGE
SPECIAL**

 **CALL**
01584 876033

 **CLICK**
www.flowfit.com

FLOWFIT®

Everything Hydraulic Since 1996.

Flowfit is a market leader in everything hydraulic, from distribution to systems and manufacturing. What began in an old miner's home in Cinderford, Gloucestershire, has grown into an internationally renowned company, which continues to make strides in the hydraulic industry. Our base here in Ludlow, Shropshire, comprises of 28500 square foot site, with our head office, trade shop, engineering department and warehousing facilities.

Our ethos is to provide 'everything hydraulic' for our vast customer base. The dedicated and knowledgeable team here at Flowfit can meet any hydraulic demand, from parts and systems to bespoke designs. There is a solution to every problem, and we have the answer. Flowfit is an industry leader in providing effective, reliable and top-quality hydraulic components, whether it be hydraulic cylinders, hydraulic hand pumps, hydraulic motors and pumps, or complete bespoke hydraulic systems.

So, what makes Flowfit an industry leader twenty-five years after its inception? First and foremost, we treat our customers with the best customer service within the industry, as they are the lifeblood of the business. We maintain vast stockholding and continuously work on supply chains, enabling staff to deliver swiftly on all customer needs. We offer expert technical support to ensure cost-effective solutions. Our flexible manufacturing solutions allow us to provide bespoke systems to suit any customer requirements.

This year we are proudly celebrating our 25th anniversary as a company. As we move on, we intend to continue investing in our staff and facilities to continue providing the best services you will find in hydraulics. Being your number one choice in hydraulics matters to us, and we want to thank you for your continued support of our business.

We hope you enjoy our latest catalogue.

With warmest thanks,

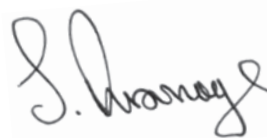

CHIEF EXECUTIVE
FLOWFIT®





Quality Products

Everything you buy from us is guaranteed for a minimum of 12 months. If during this time a manufacturers fault develops then we will either replace it free of charge or repair it. Please note all hydraulic powerunits are return to base. We are proud to be a QMS ISO 9002 Registered Firm.



Free Advice

If you are not sure what you need or you can't find a particular product – call us we're here to help you. Our Technical Sales team is given the latest training and can source and advise the best products to suit your specific needs or we can design a system to suit with our in-house audited hydraulic engineers. We will also provide technical support and a free site visit to discuss your requirements.



KEEPING INDUSTRY MOVING

HOW TO ORDER



Phone: 01584 876033

Monday - Thursday 8.30am - 5.00pm
Friday 8.00am - 4.00pm



Email: sales@flowfitonline.com

You can email your order to our fully qualified sales team 24 hours a day, 7 days a week.



By Mail

Harrier Fluid Power Ltd T/A Flowfit
Parys Road, Ludlow Business Park
Ludlow, Shropshire SY8 1XY



Online: www.flowfitonline.com

Online ordering is the quickest and most convenient way to all the industrial supplies you need, 24 hours a day, 7 days a week.



Fax: 01584 876044

Fax orders, 24/7



Visit our Trade Counter in Ludlow

**Parys Road, Ludlow Business Park,
Ludlow, Shropshire SY8 1XY**

All prices in this catalogue are excluding V.A.T.

EASY PAYMENT OPTIONS

Credit Account

Setting up a business credit account is quick and easy just fill out a credit form, downloadable from the website www.flowfitonline.com

Other Payment Methods

For your convenience we have several easy payment options for you to choose from:

Credit & Debit Cards

Cash at our Trade Counter

BACS Transfers

Paypal Payments



Satisfaction Guarantee

In the unlikely event that you are not completely satisfied with your purchase, you can return your unused stock item for a full refund. Simply retain your original packaging and contact our Customer Services on 01584 876033 and we will arrange a free collection at a time that is convenient for you.

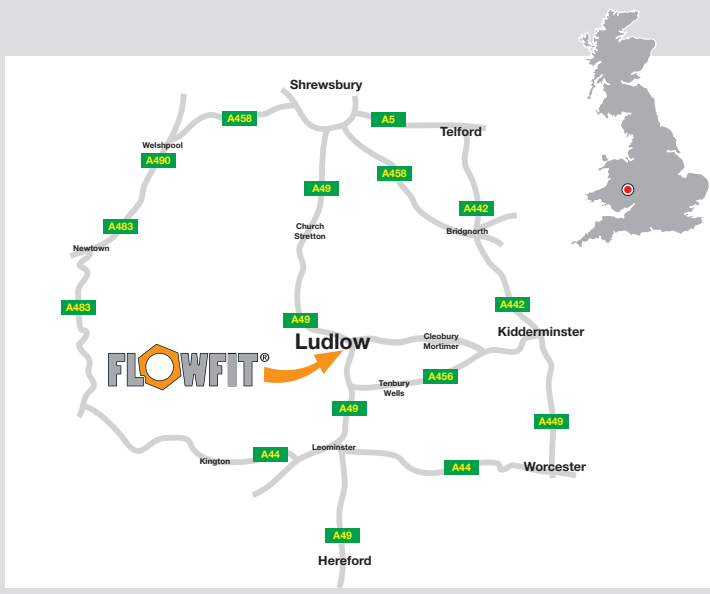

PROMOTING THE HIGHEST STANDARD IN FLUID POWER DISTRIBUTION



SECURE ONLINE ORDERING WITH FREE DELIVERY



All products in this catalogue are available to purchase online at www.flowfitonline.com

- 100% SECURE SHOPPING
- Hassle free delivery direct to your door
- NO QUIBBLE GUARANTEE
- 24 HOUR SHOPPING
- UK BASED CALL CENTRE

Selected products and special offers can also be found on our ebay store.

OVERSEAS CUSTOMERS



All items in this catalogue and at www.flowfitonline.com are available to overseas customers, please contact us for shipping costs.



**SHOP
OPEN
5 DAYS
A WEEK**

Follow us on   

FREE NEXT DAY DELIVERY ON WEB ORDERS OVER £50

Orders placed over the phone or faxed will be subject to our standard delivery charges.

**Order by 4.00pm for next day
delivery throughout the UK.**



SPECIAL DELIVERY AVAILABLE

**NEXT DAY BY 9.30am
NEXT DAY BY 10.30am
NEXT DAY BY 12 noon**



SAME DAY OR SATURDAY DELIVERY

**Contact us for a quotation should you
require this option.**



SHIP DIRECT

**Use our stock to ship directly to your
customers, no Flowfit paperwork, your
paperwork sent direct with the goods.**



CALL US TODAY

- **Cross reference service**
- **Technical support**
- **Full hydraulic system design**
- **Price challenge**
- **Friendly staff, here to help 01584 876033**



KEEPING INDUSTRY MOVING

FLOWFIT®



UK DISTRIBUTORS!!

Flowfit have a huge stock quantity of Hydraulic Filter elements available. With the help of our very own hydraulic cross reference catalogue we can matchup any replacement elements!



Call us on 01584 876033 for more information on our replacement elements or to get your replacement element catalogue now!

Visit

www.flowfitonline.com

FILTREC TECHNICAL FILTRATION

PRODUCT	PAGE
FILTREC RETURN LINE FILTERS	531
FILTREC TANK TOP RETURN LINE FILTERS	532
FILTREC LOW PRESSURE INLINE FILTERS	538
FILTREC SUCTION LINE FILTERS	539
FILTREC SUCTION STRAINERS	540
FILTREC SUCTION FILTERS	541
FILTREC MEDIUM PRESSURE FILTERS	542
FILTREC HIGH PRESSURE FILTERS	545



**FROM ONLY
£10.23
+VAT**



**FROM ONLY
£83.76
+VAT**



**FROM ONLY
£9.94
+VAT**



QUALITY PRODUCTS



FREE ADVICE

If the part number needed is not listed please ask the Flowfit Sales Team

FILTREC RETURN LINE FILTERS

IN-LINE RETURN FILTERS FA-1



www.flowfitonline.com
TECH. DATA SHEET
FTF01



FILTER HOUSING TECHNICAL INFORMATION

Description: In line low-pressure spin-on filter assemblies, suction and return lines.

Max flow rate: 300 l/min (79 gpm)

Max working pressure: As per NFPA T 3.10.17: 12 Bar (175 psi)

Test pressure: As per NFPA T 3.10.17: 15 Bar (217.5 psi)

Burst pressure: As per NFPA T 3.10.17: 20 Bar (290 psi)

Connection Ports: BSP

By-pass setting: suction line 0,25 Bar (3.6 psi) return line 1,7 Bar (24.6 psi)

Indicator: Visual and electrical

Working temperature: 25°C +120°C (-13°F +248°F)

Materials: •Head: aluminium

•Housing: carbon steel

•Seal: Buna-N

Fluids compatibility: ISO 2943: Filter assembly compatible with mineral oils and some synthetic or vegetable oils. With other fluid applications please contact Filtrac S.p.A.

FILTER ELEMENT

Filter media: Microglass fiber 3,6,10,25 µm

Cellulose 10,25 µm

Wire mesh 60, 125 µm

Collapse pressure: as per ISO 2941: 4 Bar (58 psi)

ORDER CODE	DESCRIPTION	PORTS	FLOW RATE	NETT. PRICE	ELEMENT	NETT. PRICE
SUPPLIED WITH VACUUM GAUGE INDICATOR AND BYPASS VALVE						
10 MICRON CELLULOSE						
				£ STERLING	€ EUROS	
						£ STERLING € EUROS
ZZ004770	FA-1-10-C10-B-B4-R-MPB	3/4" BSP	75 L/MIN	£22.71	€ 25.66	A110C10 £9.94 € 11.24
ZZ004771	FA-1-11-C10-B-B4-R-MPB	3/4" BSP	80 L/MIN	£38.50	€ 43.51	A111C10 £17.23 € 19.47
ZZ004772	FA-1-20-C10-B-B6-R-MPB	1 1/4" BSP	180 L/MIN	£47.33	€ 53.49	A120C10 £14.57 € 16.47
ZZ004773	FA-1-21-C10-B-B6-R-MPB	1 1/4" BSP	190 L/MIN	£49.22	€ 55.62	A121C10 £25.18 € 28.45
ZZ004774	FA-1-30-C10-B-B7-R-MPB	1 1/2" BSP	230 L/MIN	£62.48	€ 70.60	A120C10 £14.57 € 16.47
ZZ004775	FA-1-31-C10-B-B7-R-MPB	1 1/2" BSP	240 L/MIN	£75.73	€ 85.57	A121C10 £25.18 € 28.45
ZZ004776	FA-1-40-C10-B-B7-R-MPB	1 1/2" BSP	230 L/MIN	£145.15	€ 164.02	A120C10 £14.57 € 16.47
25 MICRON CELLULOSE						
ZZ004777	FA-1-10-C25-B-B4-R-MPB	3/4" BSP	80 L/MIN	£22.71	€ 25.66	A110C25 £9.94 € 11.24
ZZ004778	FA-1-11-C25-B-B4-R-MPB	3/4" BSP	85 L/MIN	£38.50	€ 43.51	A111C25 £17.23 € 19.47
ZZ004779	FA-1-20-C25-B-B6-R-MPB	1 1/4" BSP	190 L/MIN	£47.33	€ 53.49	A120C25 £14.57 € 16.47
ZZ004780	FA-1-21-C25-B-B6-R-MPB	1 1/4" BSP	195 L/MIN	£49.22	€ 55.62	A121C25 £25.18 € 28.45
ZZ004781	FA-1-30-C25-B-B7-R-MPB	1 1/2" BSP	250 L/MIN	£62.48	€ 70.60	A120C25 £14.57 € 16.47
ZZ004782	FA-1-31-C25-B-B7-R-MPB	1 1/2" BSP	270 L/MIN	£75.73	€ 85.57	A121C25 £25.18 € 28.45
ZZ004783	FA-1-40-C25-B-B7-R-MPB	1 1/2" BSP	250 L/MIN	£145.15	€ 164.02	A120C25 £14.57 € 16.47

The given flow rate values refer to applications with mineral oil having viscosity of 30 cSt at working temperature. For applications with different fluid or working conditions, a corrective factor must be applied by referring to the technical information.

INDICATORS

ORDER CODE	DESCRIPTION	NETT. PRICE	
		£ STERLING	€ EUROS
MPB	Pressure Gauge 0 + 10 BAR	£4.08	€ 4.61
MP0	Pressure Gauge 0 + 16 BAR	£4.28	€ 4.84

FILTREC TANK TOP RETURN LINE FILTERS

TANK TOP RETURN SPIN-ON FILTERS FA-2



www.flowfitonline.com
TECH. DATA SHEET
FTF02



FILTER HOUSING TECHNICAL INFORMATION

- Description:** Tank top return line spin-on filter assemblies.
- Max flow rate:** 150 l/min (40 gpm)
- Max working pressure:** As per NFPA T 3.10.17: 12 Bar (175 psi)
- Test pressure:** As per NFPA T 3.10.17: 15 Bar (217.5 psi)
- Burst pressure:** As per NFPA T 3.10.17: 20 Bar (290 psi)
- Connection Ports:** BSP
- Indicator:** Visual and electrical
- Working temperature:** -25°C +100°C (-13°F +212°F)
- Materials:**
 - Head: aluminium
 - Housing: carbon steel
 - Seal: Buna-N

Fluids compatibility: ISO 2943: Filter assembly compatible with mineral oils and some synthetic or vegetable oils. With other fluid applications please contact Filtrac S.p.A.

FILTER ELEMENT

- Filter media:**
 - Microglass fiber 3,6,10,25 µm
 - Cellulose 10,25 µm
 - Wire mesh 60, 125 µm
- Collapse pressure:** As per ISO 2941: 4 Bar (58 psi)
- By-pass setting:** Return line 1,7 Bar (24.6 psi)

ORDER CODE	DESCRIPTION	PORTS	FLOW RATE	NETT. PRICE		ELEMENT	NETT. PRICE		
10 MICRON CELLULOSE									
				£ STERLING	€ EUROS				
ZZ004784	FA-2-10-C10-B-BM-B4-MPB	3/4" BSP	80 L/MIN	£51.51	€ 58.21	A210C10BM	£16.56	€ 18.71	
ZZ004785	FA-2-11-C10-B-BM-B4-MPB	3/4" BSP	90 L/MIN	£51.51	€ 58.21	A211C10BM	£19.33	€ 21.84	
ZZ004786	FA-2-20-C10-B-BM-B7-MPB	1 1/2" BSP	250 L/MIN	£70.69	€ 79.88	A220C10BM	£23.32	€ 26.35	
ZZ004787	FA-2-21-C10-B-BM-B7-MPB	1 1/2" BSP	250 L/MIN	£71.95	€ 81.30	A221C10BM	£29.54	€ 33.38	
25 MICRON CELLULOSE									
ZZ004788	FA-2-10-C25-B-BM-B4-MPB	3/4" BSP	95 L/MIN	£51.51	€ 58.21	A210C25BM	£16.56	€ 18.71	
ZZ004789	FA-2-11-C25-B-BM-B4-MPB	3/4" BSP	105 L/MIN	£51.51	€ 58.21	A211C25BM	£19.33	€ 21.84	
ZZ004790	FA-2-20-C25-B-BM-B7-MPB	1 1/2" BSP	270 L/MIN	£70.69	€ 79.88	A220C25BM	£23.32	€ 26.35	
ZZ004791	FA-2-21-C25-B-BM-B7-MPB	1 1/2" BSP	280 L/MIN	£71.95	€ 81.30	A221C25BM	£29.54	€ 33.38	
10 MICRON FIBREGLASS									
ZZ004792	FA-2-10-G10-B-BM-B4-MPB	3/4" BSP	70 L/MIN	£67.38	€ 76.14	A210G10BM	£27.83	€ 31.44	
ZZ004793	FA-2-11-G10-B-BM-B4-MPB	3/4" BSP	75 L/MIN	£80.65	€ 91.14	A211G10BM	£38.43	€ 43.43	
ZZ004794	FA-2-20-G10-B-BM-B7-MPB	1 1/2" BSP	150 L/MIN	£105.19	€ 118.86	A220G10BM	£50.79	€ 57.39	
ZZ004795	FA-2-21-G10-B-BM-B7-MPB	1 1/2" BSP	160 L/MIN	£122.21	€ 138.10	A221G10BM	£64.41	€ 72.78	

The given flow rate values refer to applications with mineral oil having viscosity of 30 cSt at working temperature. For applications with different fluid or working conditions, a corrective factor must be applied by referring to the technical information.

INDICATORS

ORDER CODE	DESCRIPTION	NETT. PRICE	
		£ STERLING	€ EUROS
MPB	Pressure Gauge 0 ÷ 10 BAR	£4.08	€ 4.61

TANK TOP RETURN FILTER FR-1



www.flowfitonline.com
TECH. DATA SHEET
FTF03



FILTER HOUSING Technical Information

Description: Tank top mounting design return line with reusable or disposable element.

Max flow rate: 600 l/min (158 gpm)

Max working pressure: As per NFPA T 3.10.5.1: 8 Bar (116 psi)

Test pressure: As per NFPA T 3.10.5.1: 12 Bar (174 psi)

Burst pressure: As per NFPA T 3.10.5.1: 16 Bar (232 psi)

Connection Ports: BSP, NPT, SAE J514b

Indicator: Visual and electrical.

Working temperature: -25°C + 100°C (-13°F +212°F)

Materials: •Cover: aluminium

•Head: aluminium

•Bowl: nylon - carbon steel

•Seal: Buna-N / Viton®

Fluids compatibility: ISO 2943: Filter assembly compatible with mineral oils and some synthetic or vegetable oils. With other fluid applications please contact Filtrac S.p.A.

FILTER ELEMENT

Filter media: Microglass fiber 3,6,10,25 µm
Cellulose 10,25 µm
Wire mesh 60, 125 µm

Collapse pressure: As per ISO 2941: 10 Bar (145 psi)

By-pass: Return line 1,7 Bar (24.6 psi)

ORDER CODE	DESCRIPTION	PORTS	FLOW RATE	NETT. PRICE		ELEMENT	NETT. PRICE		
ALL SUPPLIED WITH R1 INDICATOR ON TOP AS STANDARD									
10 MICRON CELLULOSE									
				£ STERLING	€ EUROS				
ZZ004851	FR-1-10-C10B-B-B2-0-C-MPB	3/8"BSP	50 L/MIN	£20.19	€ 22.82	R110C10B	£7.63	€ 8.63	
ZZ004852	FR-1-10-C10B-B-B3-0-C-MPB	1/2"BSP	50L/MIN	£20.19	€ 22.82	R110C10B	£7.63	€ 8.63	
ZZ004854	FR-1-11-C10B-B-B2-0-C-MPB	3/8"BSP	60 L/MIN	£25.10	€ 28.36	R111C10B	£17.83	€ 20.15	
ZZ004855	FR-1-11-C10B-B-B3-0-C-MPB	1/2"BSP	60 L/MIN	£25.10	€ 28.36	R111C10B	£17.83	€ 20.15	
ZZ004857	FR-1-20-C10B-B-B3-0-C-MPB	1/2"BSP	65 L/MIN	£23.35	€ 26.39	R120C10B	£8.88	€ 10.04	
ZZ004858	FR-1-20-C10B-B-B4-0-C-MPB	3/4"BSP	70 L/MIN	£23.35	€ 26.39	R120C10B	£8.88	€ 10.04	
ZZ004859	FR-1-22-C10B-B-B5-0-C-MPB	1"BSP	100 L/MIN	£25.24	€ 28.52	R122C10B	£9.88	€ 11.16	
ZZ004860	FR-1-30-C10B-B-B5-0-C-MPB	1"BSP	150 L/MIN	£35.87	€ 40.53	R130C10B	£13.25	€ 14.97	
ZZ004861	FR-1-40-C10B-B-B7-0-C-MPB	1 1/2"BSP	250 L/MIN	£56.30	€ 63.62	R140C10B	£14.92	€ 16.86	
ZZ004862	FR-1-43-C10B-B-B7-0-C-MPB	1 1/2"BSP	270 L/MIN	£59.31	€ 67.03	R143C10B	£17.89	€ 20.22	
ZZ004863	FR-1-50-C10B-B-B8-0-C-MPB	2"BSP	340 L/MIN	£87.44	€ 98.81	R150C10B	£17.06	€ 19.28	
ZZ004864	FR-1-51-C10B-B-B8-0-C-MPB	2"BSP	390 L/MIN	£97.90	€ 110.63	R151C10B	£19.18	€ 21.68	
ZZ004865	FR-1-60-C10B-B-B8-0-C-MPB	2"BSP	560 L/MIN	£63.11	€ 71.31	R160C10B	£19.18	€ 21.68	
ZZ004866	FR-1-64-C10B-B-B8-0-C-MPB	2"BSP	600 L/MIN	£82.05	€ 92.71	R164C10B	£25.60	€ 28.93	
25 MICRON CELLULOSE									
ZZ004867	FR-1-10-C25B-B-B2-0-C-MPB	3/8"BSP	55 L/MIN	£20.19	€ 22.82	R110C25B	£7.63	€ 8.63	
ZZ004868	FR-1-10-C25B-B-B3-0-C-MPB	1/2"BSP	55 L/MIN	£20.19	€ 22.82	R110C25B	£7.63	€ 8.63	
ZZ004870	FR-1-11-C25B-B-B2-0-C-MPB	3/8"BSP	65 L/MIN	£25.10	€ 28.36	R111C25B	£17.83	€ 20.15	
ZZ004871	FR-1-11-C25B-B-B3-0-C-MPB	1/2"BSP	65 L/MIN	£25.10	€ 28.36	R111C25B	£17.83	€ 20.15	
ZZ004972	FR-1-20-C25B-B-B3-0-C-MPB	1/2"BSP	75 L/MIN	£23.35	€ 26.39	R120C25B	£8.88	€ 10.04	
ZZ004973	FR-1-20-C25B-B-B4-0-C-MPB	3/4"BSP	85 L/MIN	£23.35	€ 26.39	R120C25B	£8.88	€ 10.04	
ZZ004974	FR-1-22-C25B-B-B5-0-C-MPB	1"BSP	110 L/MIN	£25.24	€ 28.52	R122C25B	£9.88	€ 11.16	
ZZ004975	FR-1-30-C25B-B-B5-0-C-MPB	1"BSP	180 L/MIN	£35.87	€ 40.53	R130C25B	£13.25	€ 14.97	
ZZ004976	FR-1-40-C25B-B-B7-0-C-MPB	1 1/2"BSP	300 L/MIN	£56.30	€ 63.62	R140C25B	£14.92	€ 16.86	
ZZ004977	FR-1-43-C25B-B-B7-0-C-MPB	1 1/2"BSP	350 L/MIN	£59.31	€ 67.03	R143C25B	£21.37	€ 24.15	
ZZ004978	FR-1-50-C25B-B-B8-0-C-MPB	2"BSP	360 L/MIN	£87.44	€ 98.81	R150C25B	£17.06	€ 19.28	
ZZ004979	FR-1-51-C25B-B-B8-0-C-MPB	2"BSP	420 L/MIN	£97.90	€ 110.63	R151C25B	£19.18	€ 21.68	
ZZ004980	FR-1-60-C25B-B-B8-0-C-MPB	2"BSP	580 L/MIN	£63.11	€ 71.31	R160C25B	£19.18	€ 21.68	
ZZ004981	FR-1-64-C10B-B-B8-0-C-MPB	2"BSP	600 L/MIN	£82.05	€ 92.71	R164C25B	£25.60	€ 28.93	

The given flow rate values refer to applications with mineral oil having viscosity of 30 cSt at working temperature. For applications with different fluid or working conditions, a corrective factor must be applied by referring to the technical information.

OPTIONAL EXTRAS

VITON SEALS	NETT. PRICE	
	£ STERLING	€ EUROS
FR1-10	£3.36	€ 3.80
FR1-20/FR1-30	£8.28	€ 9.36
FR1-40	£14.01	€ 15.83
FR1-50	£34.51	€ 39.00
FR1-60	£34.51	€ 39.00

INDICATORS

ORDER CODE	DESCRIPTION	NETT. PRICE	
		£ STERLING	€ EUROS
MPB	Pressure Gauge Rear Connection for 'B' Bypass	£4.08	€ 4.61
MRB	Pressure Gauge Radial Connection for 'B' Bypass	£3.68	€ 4.16



TANK TOP RETURN FILTER FR-8



www.flowfitonline.com
TECH. DATA SHEET
FTF04



FILTER HOUSING TECHNICAL INFORMATION

Description: Tank top mounting design return line with reusable or disposable element.

Max flow rate: 150 l/min (40 gpm)

Max working pressure: As per NFPA T 3.10.5.1: 8 Bar (116 psi)

Test pressure: As per NFPA T 3.10.5.1: 12 Bar (174 psi)

Burst pressure: As per NFPA T 3.10.5.1: 16 Bar (232 psi)

Connection Ports: BSP, NPT, SAE J514b

Indicator: Visual and electrical.

Working temperature: -25°C + 100°C (-13°F +212°F)

- Materials:**
- Cover: nylon
 - Head: aluminium
 - Bowl: nylon
 - Seal: Buna-N / Viton®

Fluids compatibility: ISO 2943: Filter assembly compatible with mineral oils and some synthetic or vegetable oils. With other fluid applications please contact Filtrac S.p.A.

FILTER ELEMENT

Filter media: Microglass fiber 3,6,10,25 µm
Cellulose 10,25 µm
Wire mesh 60, 125 µm

Collapse pressure: As per ISO 2941: 10 Bar (145 psi)

By-pass: Return line 1,7 Bar (24.6 psi)

ORDER CODE	DESCRIPTION	PORTS	FLOW RATE	NETT. PRICE	ELEMENT	NETT. PRICE
ALL WITH AIR BREATHER AS STANDARD - R1 INDICATOR ON TOP						
10 MICRON CELLULOSE						
				£ STERLING	€ EUROS	
ZZ004873	FR-8-10-C10-B-B4-O-10-C-R1	3/4" BSP	16 L/MIN	£97.89	€ 110.62	R110C10B
ZZ004874	FR-8-11-C10-B-B4-O-10-C-R1	3/4" BSP	24 L/MIN	£113.44	€ 128.19	R111C10B
ZZ004875	FR-8-20-C10-B-B6-O-10-C-R1	1 1/4" BSP	50 L/MIN	£132.37	€ 149.58	R120C10B
ZZ004876	FR-8-22-C10-B-B6-O-10-C-R1	1 1/4" BSP	80 L/MIN	£135.70	€ 153.34	R122C10B
ZZ004877	FR-8-30-C10-B-B6-O-10-C-R1	1 1/4" BSP	120 L/MIN	£153.32	€ 173.25	R130C10B
25 MICRON CELLULOSE						
ZZ004878	FR-8-10-C25-B-B4-O-10-C-R1	3/4" BSP	32 L/MIN	£97.89	€ 110.62	R110C25B
ZZ004879	FR-8-11-C25-B-B4-O-10-C-R1	3/4" BSP	48 L/MIN	£113.44	€ 128.19	R111C25B
ZZ004880	FR-8-20-C25-B-B6-O-10-C-R1	1 1/4" BSP	80 L/MIN	£132.37	€ 149.58	R120C25B
ZZ004881	FR-8-22-C25-B-B6-O-10-C-R1	1 1/4" BSP	100 L/MIN	£135.70	€ 153.34	R122C25B
ZZ004882	FR-8-30-C25-B-B6-O-10-C-R1	1 1/4" BSP	140 L/MIN	£153.33	€ 173.26	R130C25B

The given flow rate values refer to applications with mineral oil having viscosity of 30 cSt at working temperature. For applications with different fluid or working conditions, a corrective factor must be applied by referring to the technical information.

OPTIONAL EXTRAS

VITON SEALS	NETT. PRICE	
	£ STERLING	
	€ EUROS	
FR-8-10 Series	£16.21	€ 18.32
FR-8-20 & 8-30 Series	£6.22	€ 7.02
SECONDARY PORT		
FR-8-10 Series		
FR-8-20 & 8-30 Series	£2.86	€ 3.23
INDICATOR POSITION		
Options C,D & S	£3.22	€ 3.64
INDICATORS		
R2 Pressure switch O.C 1.3 Bar 18.85 O.C	£17.49	€ 19.77
R3 Pressure switch C.C 1,3 Bar 18.85 Psi C.C	£17.23	€ 19.47
R6 Visual pressure 1.2 Bar 17.4 Psi	£21.63	€ 24.44
R7 Pressure vacuum gauge -1 - 5 Bar -14.5-72.5 Psi	£6.05	€ 6.83

TANK TOP RETURN FILTER FCR-7



www.flowfitonline.com
TECH. DATA SHEET
FTF05



FILTER HOUSING TECHNICAL INFORMATION

Description: Tank top mounting design return line with reusable or disposable element.

Max flow rate: 600 l/min (158 gpm)

Max working pressure: As per NFPA T 3.10.5.1: 8 Bar (116 psi)

Test pressure: As per NFPA T 3.10.5.1: 12 Bar (174 psi)

Burst pressure: As per NFPA T 3.10.5.1: 16 Bar (232 psi)

Connection Ports: BSP, NPT, SAE J514b, SAE J518

Indicator: Visual and electrical.

Working temperature: -25°C +100°C (-13°F +212°F)

By-pass setting: 0,8 or 1,7 Bar (11.6 or 24.6 psi)

Materials: •Cover: nylon - aluminium

•Head: aluminium

•Bowl: carbon steel

•Seal: Buna-N / Viton®

Fluids compatibility: ISO 2943: Filter assembly compatible with mineral oils and some synthetic orvegetable oils. With other fluid applications please contact Filtrec S.p.A.

FILTER ELEMENT

Filter media: Microglass fiber 3, 6, 10, 25 µm

Cellulose 10, 25 µm

Wire mesh 10, 25, 40, 60, 100, 120 µm

Collapse pressure: As per ISO 2941: 10 Bar (145 psi)

ORDER CODE	DESCRIPTION	PORTS	FLOW RATE	NETT. PRICE		ELEMENT	NETT. PRICE		
10 MICRON CELLULOSE									
				£ STERLING	€ EUROS			£ STERLING	€ EUROS
ZZ004796	FCR-7-11-G10-B6-O-V17-O-O-O-C-R1	1 1/4" BSP	60 L/MIN	£83.76	€ 94.65	R711G10	£22.91	€ 25.89	
ZZ004797	FCR-7-12-G10-B6-O-V17-O-O-O-C-R1	1 1/4" BSP	65 L/MIN	£86.71	€ 97.98	R712G10	£25.75	€ 29.09	
ZZ004798	FCR-7-13-G10-B6-O-V17-O-O-O-C-R1	1 1/4" BSP	75 L/MIN	£92.72	€ 104.77	R713G10	£36.08	€ 40.77	
ZZ004799	FCR-7-14-G10-B6-O-V17-O-O-O-C-R1	1 1/4" BSP	90 L/MIN	£100.86	€ 113.98	R714G10	£46.61	€ 52.67	
ZZ004800	FCR-7-20-G10-B7-O-V17-O-O-O-C-R1	1 1/2" BSP	175 L/MIN	£173.60	€ 196.16	R720G10	£48.13	€ 54.39	
ZZ004801	FCR-7-21-G10-B7-O-V17-O-O-O-C-R1	1 1/2" BSP	200 L/MIN	£179.58	€ 202.93	R721G10	£56.10	€ 63.39	
ZZ004802	FCR-7-22-G10-B7-O-V17-O-O-O-C-R1	1 1/2" BSP	250 L/MIN	£200.76	€ 226.86	R722G10	£83.06	€ 93.85	
ZZ004803	FCR-7-30-G10-B8-O-V17-O-O-O-C-R1	2" BSP	270 L/MIN	£289.49	€ 327.12	R730G10	£57.07	€ 64.49	
ZZ004804	FCR-7-31-G10-B8-O-V17-O-O-O-C-R1	2" BSP	330 L/MIN	£299.31	€ 338.22	R731G10	£69.97	€ 79.07	
ZZ004805	FCR-7-32-G10-B8-O-V17-O-O-O-C-R1	2" BSP	400 L/MIN	£323.01	€ 365.00	R732G10	£86.80	€ 98.09	
ZZ004806	FCR-7-33-G10-B8-O-V17-O-O-O-C-R1	2" BSP	400 L/MIN	£314.30	€ 355.16	R733G10	£87.06	€ 98.37	
25 MICRON FIBREGLASS									
ZZ004807	FCR-7-11-G25-B6-O-V17-O-O-O-C-R1	1 1/4" BSP	70 L/MIN	£83.76	€ 94.65	R711G25	£22.91	€ 25.89	
ZZ004808	FCR-7-12-G25-B6-O-V17-O-O-O-C-R1	1 1/4" BSP	80 L/MIN	£86.71	€ 97.98	R712G25	£25.75	€ 29.09	
ZZ004809	FCR-7-13-G25-B6-O-V17-O-O-O-C-R1	1 1/4" BSP	90 L/MIN	£92.72	€ 104.77	R713G25	£36.08	€ 40.77	
ZZ004810	FCR-7-14-G25-B6-O-V17-O-O-O-C-R1	1 1/4" BSP	100 L/MIN	£100.86	€ 113.98	R714G25	£46.61	€ 52.67	
ZZ004811	FCR-7-20-G25-B7-O-V17-O-O-O-C-R1	1 1/2" BSP	200 L/MIN	£173.60	€ 196.16	R720G25	£48.13	€ 54.39	
ZZ004812	FCR-7-21-G25-B7-O-V17-O-O-O-C-R1	1 1/2" BSP	250 L/MIN	£179.58	€ 202.93	R721G25	£56.10	€ 63.39	
ZZ004813	FCR-7-22-G25-B7-O-V17-O-O-O-C-R1	1 1/2" BSP	250 L/MIN	£200.76	€ 226.86	R722G25	£83.06	€ 93.85	
ZZ004814	FCR-7-30-G25-B8-O-V17-O-O-O-C-R1	2" BSP	360 L/MIN	£289.49	€ 327.12	R730G25	£57.07	€ 64.49	
ZZ004815	FCR-7-31-G25-B8-O-V17-O-O-O-C-R1	2" BSP	450 L/MIN	£299.31	€ 338.22	R731G25	£69.97	€ 79.07	
ZZ004816	FCR-7-32-G25-B8-O-V17-O-O-O-C-R1	2" BSP	480 L/MIN	£323.01	€ 365.00	R732G25	£87.06	€ 98.37	
ZZ004817	FCR-7-33-G25-B8-O-V17-O-O-O-C-R1	2" BSP	580 L/MIN	£314.30	€ 355.16	R733G25	£87.06	€ 98.37	

The given flow rate values refer to applications with mineral oil having viscosity of 30 cSt at working temperature. For applications with different fluid or working conditions, a corrective factor must be applied by referring to the technical information.

OPTIONAL EXTRAS

OPTIONAL EXTRAS CONTINUED ON NEXT PAGE

VITON SEALS	NETT. PRICE	
	£ STERLING	€ EUROS
FCR-7-11 Series	£52.70	€ 59.55
FCR-7-20 series	£77.19	€ 87.22
FCR-7-30 Series	£101.20	€ 114.35
SECONDARY PORTS		
All series	£5.90	€ 6.67

OPTIONAL EXTRAS

MAGNETS	NETT. PRICE	
	£ STERLING	€ EUROS
FCR-7-11 Series	£28.57	€ 32.28
FCR-7-20 series	£52.53	€ 59.36
FCR-7-30 Series	£76.23	€ 86.14

DIFFUSERS	NETT. PRICE	
	£ STERLING	€ EUROS
FCR-7-11	£53.64	€ 60.62
FCR-7-12	£53.64	€ 60.62
FCR-7-13	£57.26	€ 64.70
FCR-7-14	£61.06	€ 68.99
FCR-7-20	£88.58	€ 100.09
FCR-7-21	£116.41	€ 131.55
FCR-7-22	£125.59	€ 141.92
FCR-7-30	£89.70	€ 101.36
FCR-7-31	£98.58	€ 111.40
FCR-7-32	£107.56	€ 121.55
FCR-7-33	£118.43	€ 133.83

FILLER CAP	NETT. PRICE	
	£ STERLING	€ EUROS
FCR-7-20 series	£15.27	€ 17.25
FCR-7-30 Series	£17.91	€ 20.24

INDICATORS

ORDER CODE	DESCRIPTION	NETT. PRICE	
		£ STERLING	€ EUROS
MPB	Pressure Gauge Rear Connection		
MRB	Pressure Gauge Radial Connection		
PDB	Pressure Switch		

IN TANK RETURN LINE FILTER FVR-7



ORDER CODE	DESCRIPTION	FLOW RATE	NETT. PRICE		ELEMENT	NETT. PRICE	
			£ STERLING	€ EUROS		£ STERLING	€ EUROS
10 MICRON CELLULOSE							
ZZ004818	FVR-7-11-C10B-B-0-0	110 L/MIN	£45.19	€ 51.07	R711C10	£16.49	€ 18.63
ZZ004819	FVR-7-12-C10B-B-0-0	120 L/MIN	£46.88	€ 52.98	R712C10	£17.64	€ 19.93
ZZ004820	FVR-7-13-C10B-B-0-0	200 L/MIN	£50.67	€ 57.26	R713C10	£24.65	€ 27.86
ZZ004821	FVR-7-14-C10B-B-0-0	220 L/MIN	£58.24	€ 65.82	R714C10	£30.74	€ 34.74
ZZ004822	FVR-7-20-C10B-B-0-0	250 L/MIN	£71.40	€ 80.88	R720C10	£27.79	€ 31.41
ZZ004823	FVR-7-21-C10B-B-0-0	270 L/MIN	£73.83	€ 83.42	R721C10	£30.83	€ 34.84
ZZ004824	FVR-7-22-C10B-B-0-0	300 L/MIN	£83.87	€ 94.78	R722C10	£42.65	€ 48.20
ZZ004825	FVR-7-30-C10B-B-0-0	300 L/MIN	£177.35	€ 200.40	R730C10	£32.72	€ 36.97
ZZ004826	FVR-7-31-C10B-B-0-0	400 L/MIN	£182.00	€ 205.66	R731C10	£37.44	€ 42.31
ZZ004827	FVR-7-32-C10B-B-0-0	500 L/MIN	£193.32	€ 218.45	R732C10	£51.07	€ 57.71
ZZ004828	FVR-7-33-C10B-B-0-0	600 L/MIN	£189.92	€ 214.61	R733C10	£45.73	€ 51.67
ZZ004829	FVR-7-11-G10B-B-0-0	60 L/MIN	£48.97	€ 55.34	R711G10	£22.91	€ 25.89
ZZ004830	FVR-7-12-G10B-B-0-0	80 L/MIN	£51.83	€ 58.57	R712G10	£25.75	€ 29.09
ZZ004831	FVR-7-13-G10B-B-0-0	100 L/MIN	£57.68	€ 65.17	R713G10	£36.08	€ 40.77
ZZ004832	FVR-7-14-G10B-B-0-0	140 L/MIN	£68.18	€ 77.04	R714G10	£46.61	€ 52.67
ZZ004833	FVR-7-20-G10B-B-0-0	180 L/MIN	£84.82	€ 95.85	R720G10	£48.13	€ 54.39
ZZ004834	FVR-7-21-G10B-B-0-0	200 L/MIN	£90.71	€ 102.50	R721G10	£56.10	€ 63.39
ZZ004835	FVR-7-22-G10B-B-0-0	280 L/MIN	£111.27	€ 125.73	R722G10	£83.06	€ 93.85
ZZ004836	FVR-7-30-G10B-B-0-0	300 L/MIN	£193.45	€ 218.60	R730G10	£57.07	€ 64.49
ZZ004837	FVR-7-31-G10B-B-0-0	330 L/MIN	£203.88	€ 230.38	R731G10	£69.97	€ 79.07
ZZ004838	FVR-7-32-G10B-B-0-0	400 L/MIN	£226.32	€ 255.74	R732G10	£87.01	€ 98.33
ZZ004839	FVR-7-33-G10B-B-0-0	400 L/MIN	£217.82	€ 246.14	R733G10	£87.06	€ 98.37
ZZ004840	FVR-7-11-G25B-B-0-0	100 L/MIN	£48.97	€ 55.34	R711G25	£22.91	€ 25.89
ZZ004841	FVR-7-12-G25B-B-0-0	120 L/MIN	£51.83	€ 58.57	R712G25	£25.75	€ 29.09
ZZ004842	FVR-7-13-G25B-B-0-0	180 L/MIN	£57.68	€ 65.17	R713G25	£36.08	€ 40.77
ZZ004843	FVR-7-14-G25B-B-0-0	200 L/MIN	£68.18	€ 77.04	R714G25	£46.61	€ 52.67
ZZ004844	FVR-7-20-G25B-B-0-0	200 L/MIN	£84.82	€ 95.85	R720G25	£48.13	€ 54.39
ZZ004845	FVR-7-21-G25B-B-0-0	240 L/MIN	£90.71	€ 102.50	R721G25	£56.10	€ 63.39
ZZ004846	FVR-7-22-G25B-B-0-0	360 L/MIN	£111.27	€ 125.73	R722G25	£83.06	€ 93.85
ZZ004847	FVR-7-30-G25B-B-0-0	360 L/MIN	£193.45	€ 218.60	R730G25	£57.07	€ 64.49
ZZ004848	FVR-7-31-G25B-B-0-0	400 L/MIN	£203.88	€ 230.38	R731G25	£69.97	€ 79.07
ZZ004849	FVR-7-32-G25B-B-0-0	420 L/MIN	£226.32	€ 255.74	R732G25	£87.06	€ 98.37
ZZ004850	FVR-7-33-G25B-B-0-0	440 L/MIN	£217.82	€ 246.14	R733G25	£87.06	€ 98.37

TECHNICAL INFORMATION:

Description: In tank mounting design return line with reusable or disposable element.

Max flow rate:
600 l/min (158 gpm)

Working temperature:
-30C + 110C

By-pass setting:
0,8 or 1,7 Bar

Materials: Head:
Aluminium

Seal:
Buna-N /Viton

FILTER ELEMENT

Filter media:
Microglass fiber
3,6,10,25um
Cellulose 10, 25um
Wire mesh,
10,25,40,60,100,120 um

Collapse pressure:
As per ISO 2941: 10 Bar
(145 psi)



The given Flow Rates may differ if non Filtrac Housing is used for the FVR-7 Filter.

FILTREC LOW PRESSURE INLINE FILTER

INLINE SPIN-ON FILTER FA-4



www.flowfitonline.com
TECH. DATA SHEET
FTF06



FILTER HOUSING TECHNICAL INFORMATION

Description: In line pressure and return spin-on filter assemblies.

Max flow rate: 200 l/min (53 gpm)

Max working pressure: As per NFPA T 3.10.17

Test pressure: As per NFPA T 3.10.17

Burst pressure: As per NFPA T 3.10.17

Pressure fatigue test: As per NFPA T 3.10.17

Connection Ports: BSP, NPT

By-pass setting: 3,5 Bar (50 psi)

Indicator: Visual and electrical

Working temperature: -25°C +120°C (-13°F +248°F)

Materials: •Head: aluminium

•Housing: carbon steel + aluminium

•Seal: Buna-N (NBR) / Viton®

Fluids compatibility: ISO 2943: Filter assembly compatible with mineral oils and some synthetic or vegetable oils. With other fluid applications please contact Filtrec S.p.A.

FILTER ELEMENT

Filter media: Microglass fiber 3, 6, 10, 15, 25, 40 µm

Cellulose 10, 25 µm

Wire mesh 150 µm

Collapse pressure: As per ISO 2941

FA-4- 1 X	FA-4-21
500 psi	348 psi
754 psi	522 psi
1.000 psi	798 psi
0-500 psi*	0-348 psi*

* > 100.000 cycles

FA-4-1X	FA-4-21
15 Bar	12 Bar

ORDER CODE	DESCRIPTION	PORTS	FLOW RATE	NETT. PRICE		ELEMENT	NETT. PRICE		
10 MICRON CELLULOSE									
				£ STERLING	€ EUROS				
ZZ004883	FA-4-05-C10-B-B4-D-Z34	3/4" BSP	70 L/MIN	£77.94	€ 88.07	A405C10	£34.70	€ 39.21	
ZZ004884	FA-4-11-C10-B-B4-D-Z34	3/4" BSP	80 L/MIN	£77.63	€ 87.72	A411C10	£43.02	€ 48.61	
ZZ004885	FA-4-12-C10-B-B5-D-Z34	1" BSP	110 L/MIN	£81.03	€ 91.56	A412C10	£44.84	€ 50.66	
ZZ004886	FA-4-13-C10-B-B5-D-Z34	1" BSP	160 L/MIN	£81.21	€ 91.76	A413C10	£48.92	€ 55.28	
ZZ004887	FA-4-21-C10-B-B6-D-Z34	1 1/4" BSP	200 L/MIN	£105.64	€ 119.37	A421C10	£71.09	€ 80.33	
10 MICRON FIBREGLASS									
ZZ004888	FA-4-05-G10-B-B4-D-Z34	3/4" BSP	60 L/MIN	£77.45	€ 87.52	A405G10	£42.76	€ 48.31	
ZZ004889	FA-4-11-G10-B-B4-D-Z34	3/4" BSP	70 L/MIN	£79.11	€ 89.39	A411G10	£45.48	€ 51.39	
ZZ004890	FA-4-12-G10-B-B5-D-Z34	1" BSP	100 L/MIN	£81.40	€ 91.98	A412G10	£49.22	€ 55.62	
ZZ004891	FA-4-13-G10-B-B5-D-Z34	1" BSP	120 L/MIN	£83.77	€ 94.66	A413G10	£53.11	€ 60.01	
ZZ004892	FA-4-21-G10-B-B6-D-Z34	1 1/4" BSP	200 L/MIN	£110.53	€ 124.90	A421G10	£79.14	€ 89.43	
25 MICRON FIBREGLASS									
ZZ004893	FA-4-05-G25-B-B4-D-Z34	3/4" BSP	80 L/MIN	£77.37	€ 87.43	A405G25	£42.76	€ 48.31	
ZZ004894	FA-4-11-G25-B-B4-D-Z34	3/4" BSP	100 L/MIN	£78.59	€ 88.81	A411G25	£45.45	€ 51.36	
ZZ004895	FA-4-12-G25-B-B5-D-Z34	1" BSP	120 L/MIN	£81.40	€ 91.98	A412G25	£45.99	€ 51.97	
ZZ004896	FA-4-13-G25-B-B5-D-Z34	1" BSP	140 L/MIN	£82.85	€ 93.61	A413G25	£51.59	€ 58.29	
ZZ004897	FA-4-21-G25-B-B6-D-Z34	1 1/4" BSP	200 L/MIN	£108.84	€ 122.99	A421G25	£76.37	€ 86.29	

The given flow rate values refer to applications with mineral oil having viscosity of 30 cSt at working temperature. For applications with different fluid or working conditions, a corrective factor must be applied by referring to the technical information.

INDICATORS

ORDER CODE	DESCRIPTION	NETT. PRICE	
		£ STERLING	€ EUROS
Z34	Differential Visual 2,7 Bar	£20.66	€ 23.35
Z35	Differential Electrical 2,7 Bar	£20.66	€ 23.35

FILTREC SUCTION LINE FILTERS

SUCTION LINE SPIN-ON FILTER FA-1



www.flowfitonline.com
TECH. DATA SHEET
FTF07



FILTER HOUSING TECHNICAL INFORMATION

Description: In line low-pressure spin-on filter assemblies, suction and return lines.

Max flow rate: 300 l/min (79 gpm)

Max working pressure: As per NFPA T 3.10.17: 12 Bar (175 psi)

Test pressure: As per NFPA T 3.10.17: 15 Bar (217.5 psi)

Burst pressure: As per NFPA T 3.10.17: 20 Bar (290 psi)

Connection Ports: BSP

By-pass setting: suction line 0,25 Bar (3.6 psi) return line 1,7 Bar (24.6 psi)

Indicator: Visual and electrical

Working temperature: 25°C +120°C (-13°F +248°F)

- Materials:**
- Head: aluminium
 - Housing: carbon steel
 - Seal: Buna-N

Fluids compatibility: ISO 2943: Filter assembly compatible with mineral oils and some synthetic or vegetable oils. With other fluid applications please contact Filtrac S.p.A.

FILTER ELEMENT

- Filter media:**
- Microglass fiber 3,6,10,25 µm
 - Cellulose 10,25 µm
 - Wire mesh 60, 125 µm

Collapse pressure: as per ISO 2941: 4 Bar (58 psi)

ORDER CODE	DESCRIPTION	PORTS	FLOW RATE	NETT. PRICE	ELEMENT	NETT. PRICE
SUPPLIED WITH VACUUM GAUGE INDICATOR AND BYPASS VALVE						
60 MICRON WIREMESH						
				£ STERLING	€ EUROS	
ZZ004898	FA-1-10-T60B-B4-S-MPS	3/4" BSP	30 L/MIN	£53.80	€ 60.80	A110T60
ZZ004899	FA-1-11-T60B-B4-S-MPS	3/4" BSP	40 L/MIN	£54.90	€ 62.04	A111T60
ZZ004900	FA-1-20-T60B-B6-S-MPS	1 1/4" BSP	95 L/MIN	£73.84	€ 83.43	A120T60
ZZ004901	FA-1-21-T60B-B6-S-MPS	1 1/4" BSP	100 L/MIN	£80.15	€ 90.57	A121T60
ZZ004902	FA-1-30-T60B-B7-S-MPS	1 1/2" BSP	150 L/MIN	£93.40	€ 105.54	A120T60
ZZ004903	FA-1-31-T60B-B7-S-MPS	1 1/2" BSP	150 L/MIN	£100.34	€ 113.38	A121T60
ZZ004904	FA-1-40-T60B-B7-S-MPS	1 1/2" BSP	150 L/MIN	£244.55	€ 276.34	A120T60
125 MICRON WIREMESH						
ZZ004905	FA-1-10-T125B-B4-S-MPS	3/4" BSP	40 L/MIN	£40.39	€ 45.64	A110T125
ZZ004906	FA-1-11-T125B-B4-S-MPS	3/4" BSP	40 L/MIN	£60.00	€ 67.80	A111T125
ZZ004907	FA-1-20-T125B-B6-S-MPS	1 1/4" BSP	100 L/MIN	£54.90	€ 62.04	A120T125
ZZ004908	FA-1-21-T125B-B6-S-MPS	1 1/4" BSP	110 L/MIN	£75.73	€ 85.57	A121T125
ZZ004909	FA-1-30-T125B-B7-S-MPS	1 1/2" BSP	180 L/MIN	£93.40	€ 105.54	A120T125
ZZ004910	FA-1-31-T125B-B7-S-MPS	1 1/2" BSP	180 L/MIN	£171.42	€ 193.71	A121T125
ZZ004911	FA-1-40-T125B-B7-S-MPS	1 1/2" BSP	180 L/MIN	£265.83	€ 300.39	A120T125

The given flow rate values refer to applications with mineral oil having viscosity of 30 cSt at working temperature. For applications with different fluid or working conditions, a corrective factor must be applied by referring to the technical information.

INDICATORS

ORDER CODE	DESCRIPTION	NETT. PRICE	
		£ STERLING	€ EUROS
MPS	Vacuum Gauge 0 + -1 Bar	£7.90	€ 8.93

FILTREC SUCTION STRAINERS

SUCTION STRAINERS FS-1



www.flowfitonline.com
TECH. DATA SHEET
FTF08



FILTER HOUSING TECHNICAL INFORMATION

Description: Suction strainers for fluid reservoirs.

Max flow rate: 500 l/min (132 gpm)

Collapse pressure: 14,5 psi

Port Connection: BSP (NPT on request)

By-pass: No by-pass or 0,25 bar (3,6 psi) setting

Working temperature: -25°C + 100°C (-13°F +212°F)

Materials: •Head: nylon

•Endcap: zinc plated carbon steel

•By-pass: NBR

Filter media: Wire mesh 125 µm (60 and 250 µm on request)

Fluids compatibility: ISO 2943: Filter assembly compatible with mineral oils and some synthetic or vegetable oils.

For other fluids please contact our Customer Service (info@filtrec.it).

ORDER CODE	FLOW RATE	THREAD	LENGTH	O/D	NETT. PRICE	
125 MICRON WIREMESH						
					£ STERLING	€ EUROS
FS110B2T125	16 L/MIN	3/8" BSP	91mm	46mm	£10.23	€ 11.56
FS111B3T125	26 L/MIN	1/2" BSP	106mm	46mm	£10.35	€ 11.70
FS120B4T125	45 L/MIN	3/4" BSP	109mm	64mm	£11.82	€ 13.36
FS121B5T125	65 L/MIN	1" BSP	139mm	64mm	£12.35	€ 13.95
FS130B5T125	65 L/MIN	1" BSP	139mm	86mm	£15.12	€ 17.09
FS130B6T125	110 L/MIN	1 1/4" BSP	139mm	86mm	£14.76	€ 16.68
FS130B7T125	150 L/MIN	1 1/2" BSP	139mm	86mm	£14.76	€ 16.68
FS133B7T125	150 L/MIN	1 1/2" BSP	200mm	86mm	£16.44	€ 18.58
FS134B8T125	240 L/MIN	2" BSP	260mm	86mm	£18.39	€ 20.78
FS140B7T125	150 L/MIN	1 1/2" BSP	151mm	150mm	£25.20	€ 28.48
FS140B8T125	240 L/MIN	2" BSP	151mm	150mm	£24.34	€ 27.50
FS142B9T125	380 L/MIN	2 1/2" BSP	212mm	150mm	£27.92	€ 31.55
FS143B10T125	500 L/MIN	3" BSP	272mm	150mm	£31.02	€ 35.05
FS150B2T125	16 L/MIN	3/8" BSP	84mm	54mm	£11.54	€ 13.04
FS150B3T125	26 L/MIN	1/2" BSP	84mm	54mm	£12.26	€ 13.86
FS160B3T125	26 L/MIN	1/2" BSP	104mm	72.5mm	£14.52	€ 16.41
FS160B4T125	45 L/MIN	3/4" BSP	104mm	72.5mm	£14.43	€ 16.30
FS160B5T125	65 L/MIN	1" BSP	104mm	72.5mm	£14.43	€ 16.30
FS160B6T125	110 L/MIN	1 1/4" BSP	104mm	72.5mm	£15.57	€ 17.60
FS162B3T125	26 L/MIN	1/2" BSP	148mm	72.5mm	£15.61	€ 17.64
FS162B4T125	45 L/MIN	3/4" BSP	148mm	72.5mm	£16.41	€ 18.54
FS162B5T125	65 L/MIN	1" BSP	148mm	72.5mm	£16.53	€ 18.68
FS162B6T125	110 L/MIN	1 1/4" BSP	148mm	72.5mm	£16.53	€ 18.68
FS170B5T125	65 L/MIN	1" BSP	155mm	102mm	£21.14	€ 23.88
FS170B6T125	110 L/MIN	1 1/4" BSP	155mm	102mm	£20.08	€ 22.69
FS170B7T125	150 L/MIN	1 1/2" BSP	155mm	102mm	£21.17	€ 23.92
FS170B8T125	240 L/MIN	2" BSP	155mm	102mm	£21.14	€ 23.88
FS173B5T125	65 L/MIN	1" BSP	195mm	102mm	£27.50	€ 31.07
FS173B6T125	110 L/MIN	1 1/4" BSP	195mm	102mm	£27.52	€ 31.10
FS173B7T125	150 L/MIN	1 1/2" BSP	195mm	102mm	£27.52	€ 31.10
FS173B8T125	240 L/MIN	2" BSP	195mm	102mm	£26.64	€ 30.10
FS176B5T125	65 L/MIN	1" BSP	228mm	102mm	£30.42	€ 34.37
FS176B6T125	110 L/MIN	1 1/4" BSP	228mm	102mm	£30.42	€ 34.37
FS176B7T125	240 L/MIN	1 1/2" BSP	228mm	102mm	£30.60	€ 34.57
FS176B8T125	240 L/MIN	2" BSP	228mm	102mm	£30.60	€ 34.57
FS179B5T125	65 L/MIN	1" BSP	110mm	102mm	£21.24	€ 24.00
FS180B8T125	250 L/MIN	2" BSP	202mm	132.5mm	£38.89	€ 43.95
FS180B9T125	380 L/MIN	2 1/2" BSP	202mm	132.5mm	£37.95	€ 42.88
FS180B10T125	500 L/MIN	3" BSP	202mm	132.5mm	£38.89	€ 43.95
FS181B8T125	240 L/MIN	2" BSP	162mm	132.5mm	£46.68	€ 52.75
FS181B10T125	500 L/MIN	3" BSP	162mm	132.5mm	£40.01	€ 45.21

The given flow rate values refer to applications with mineral oil having viscosity of 30 cSt at working temperature. For applications with different fluid or working conditions, a corrective factor must be applied by referring to the technical information.

FILTREC SUCTION FILTERS

TANK TOP SUCTION FILTERS FS-7



www.flowfitonline.com
TECH. DATA SHEET
FTF09



FILTER HOUSING TECHNICAL INFORMATION

Description: Side tank suction filters mounted below oil level. No need to drain oil from tank when replacing element.

Max flow rate: 160 l/min (42 gpm)

Indicator: Visual or electrical

By-pass setting: No by-pass or 0,3 Bar setting (4,35 psi)

Working temperature: -25°C + 100°C (-13°F +212°F)

Materials:

- Cover: nylon
- Housing: aluminium
- Seal: Buna-N / Viton®

Fluids compatibility: ISO 2943: Filter assembly compatible with mineral oils and some synthetic or vegetable oils. With other fluid applications please contact Filtrec S.p.A.

FILTER ELEMENT

Filter media: Cellulose 10, 25 µm
Wire mesh 60, 125, 250 µm

ORDER CODE	DESCRIPTION	PORTS	FLOW RATE	NETT. PRICE		ELEMENT	NETT. PRICE	
10 MICRON CELLULOSE								
				£ STERLING	€ EUROS		£ STERLING	€ EUROS
ZZ004912	FS-7-41-C10B-B7-0-B-O-P-MPS	1 1/2" BSP	160 L/MIN	£154.89	€ 175.02	S741C10	£41.73	€ 47.15
125 MICRON WIREMESH								
ZZ004913	FS-7-41-T125B-B7-0-B-O-P-MPS	1 1/2" BSP	200 L/MIN	£161.42	€ 182.40	S741T125	£47.90	€ 54.13

The given flow rate values refer to applications with mineral oil having viscosity of 30 cSt at working temperature. For applications with different fluid or working conditions, a corrective factor must be applied by referring to the technical information.

OPTIONAL EXTRAS

	NETT. PRICE	
	£ STERLING	€ EUROS
Secondary port	£12.25	€ 13.85
Magnet	£2.66	€ 3.00

INDICATORS

ORDER CODE	DESCRIPTION	NETT. PRICE	
		£ STERLING	€ EUROS
MPS	Vacuum Gauge Scale 0 ÷ -1 Bar	£7.90	€ 8.93

FILTREC MEDIUM PRESSURE FILTERS

INLINE MEDIUM PRESSURE FILTERS F100 MAX WORKING UPTO 100BAR



www.flowfitonline.com
TECH. DATA SHEET
FTF10



FILTER HOUSING TECHNICAL INFORMATION

Description: In line medium pressure filter assembly with cleanable or disposable elements

Max flow rate: 400 l/min (105.5 gpm)

Max working pressure: As per NFPA T 3.10.5.1:

Test pressure: As per NFPA T 3.10.5.1:

Burst pressure: As per NFPA T 3.10.5.1:

F100-XDO40/063/100	F100-XD160/250/400
100 Bar (1450 psi)	80 Bar (1160 psi)
150 Bar (2176 psi)	120 Bar (1740 psi)
300 Bar (4351 psi)	200 Bar (2900 psi)

Connection Ports: BSP, NPT

By-pass: No By-pass or 6 Bar (87 psi) setting

Working temperature: -25°C +120°C (-13°F +248°F)

Materials: •Head: aluminium

•Bowl: aluminium

•Seal: Buna-N / Viton®

Fluids compatibility: ISO 2943: Filter assembly compatible with mineral oils and some synthetic or vegetable oils. With other fluid applications please contact Filtrac S.p.A.

FILTER ELEMENT

Filter media: Filter element dimensions according to DIN 24550
Microglass fiber 3, 6, 10, 15, 25 µ, cellulose 10 µ

Collapse pressure: As per ISO 2941: 21 Bar (305 psi) and 210 Bar (3045 psi)

ORDER CODE	DESCRIPTION	PORTS	FLOW RATE	NETT. PRICE		ELEMENT	NETT. PRICE	
COMPLETE WITH LOW COLLAPSE ELEMENT, VISUAL INDICATOR AND BYPASS								
10 MICRON FIBREGLASS								
				£ STERLING	€ EUROS		£ STERLING	€ EUROS
ZZ004914	F100-XD-040-G10A-B-B5-D-W-V05	1" BSP	75 L/MIN	£183.73	€ 207.61	XD040G10A	£53.06	€ 59.95
ZZ004915	F100-XD-063-G10A-B-B5-D-W-V05	1" BSP	90 L/MIN	£192.36	€ 217.37	XD063G10A	£55.78	€ 63.03
ZZ004916	F100-XD-100-G10A-B-B5-D-W-V05	1" BSP	110 L/MIN	£208.36	€ 235.45	XD100G10A	£62.04	€ 70.11
ZZ004917	F100-XD-160-G10A-B-B7-D-W-V05	1 1/2" BSP	240 L/MIN	£201.71	€ 227.93	XD160G10A	£75.55	€ 85.37
ZZ004918	F100-XD-250-G10A-B-B7-D-W-V05	1 1/2" BSP	280 L/MIN	£208.20	€ 235.27	XD250G10A	£75.55	€ 85.37
ZZ004919	F100-XD-400-G10A-B-B7-D-W-V05	1 1/2" BSP	340 L/MIN	£268.32	€ 303.20	XD400G10A	£136.99	€ 154.80
25 MICRON FIBREGLASS								
ZZ004920	F100-XD-040-G25A-B-B5-D-W-V05	1" BSP	90 L/MIN	£183.73	€ 207.61	XD040G25A	£53.06	€ 59.95
ZZ004921	F100-XD-063-G25A-B-B5-D-W-V05	1" BSP	105 L/MIN	£192.36	€ 217.37	XD063G25A	£55.78	€ 63.03
ZZ004922	F100-XD-100-G25A-B-B5-D-W-V05	1" BSP	120 L/MIN	£208.36	€ 235.45	XD100G25A	£62.04	€ 70.11
ZZ004923	F100-XD-160-G25A-B-B7-D-W-V05	1 1/2" BSP	320 L/MIN	£202.26	€ 228.56	XD160G25A	£75.55	€ 85.37
ZZ004924	F100-XD-250-G25A-B-B7-D-W-V05	1 1/2" BSP	360 L/MIN	£208.20	€ 235.27	XD250G25A	£75.55	€ 85.37
ZZ004925	F100-XD-400-G25A-B-B7-D-W-V05	1 1/2" BSP	380 L/MIN	£268.32	€ 303.20	XD400G25A	£136.99	€ 154.80

The given flow rate values refer to applications with mineral oil having viscosity of 30 cSt at working temperature. For applications with different fluid or working conditions, a corrective factor must be applied by referring to the technical information.

OPTIONAL EXTRAS

		NETT. PRICE	
VITON SEALS			
		£ STERLING	€ EUROS
F100-XD040, XD063 & XD100		£8.57	€ 9.68
F100-XD160, XD250 & XD400		£8.57	€ 9.68

INDICATORS

ORDER CODE	DESCRIPTION	NETT. PRICE	
		£ STERLING	€ EUROS
V05	Differential Visual 5 Bar		
E05	Differential Electrical 5 Bar		
V08	Differential Visual 8 Bar		
E08	Differential Electrical 8 Bar		

INLINE MEDIUM PRESSURE FILTERS FD-3 UPTO 110BAR



www.flowfitonline.com
TECH. DATA SHEET
FTF11



FILTER HOUSING TECHNICAL INFORMATION

Description: In line medium pressure filter assembly with reusable or disposable element.

Max flow rate: 40 l/min (10,5 gpm)

Max working pressure: As per NFPA T 3.10.5.1: 110 Bar (1595 psi)

Test pressure: As per NFPA T 3.10.5.1: 160 Bar (2320 psi)

Burst pressure: As per NFPA T 3.10.5.1: 330 Bar (4785 psi)

Fatigue test: > 1.000.000 cycles 0-80 Bar, as per NFPA T 3.10.5.1

Connection Ports: BSP, NPT

By-pass: No by-pass or 6 Bar (87 psi) setting

Indicator: Differential visual and differential electrical visual , 5 Bar (72.5 psi) setting.

Working temperature: -25°C + 120°C (-13°F +248°F)

Materials: •Head: aluminium

•Bowl: aluminium

•Seal: Buna-N / Viton[®]

Fluids compatibility: ISO 2943: Filter assembly compatible with mineral oils and some synthetic or applications please contact Filtrac S.p.A.vegetable oils. With other fluid

FILTER ELEMENT

Filter media: Microglass fiber 3,6,10,25 µm

Cellulose 10,25 µm

Wire mesh 10, 25, 60, 125 µm

Collapse pressure: as per ISO 2941: 21 Bar (305 psi)

ORDER CODE	DESCRIPTION	PORTS	FLOW RATE	NETT. PRICE		ELEMENT	NETT. PRICE	
COMPLETE WITH LOW COLLAPSE ELEMENT, VISUAL INDICATOR AND BYPASS								
10 MICRON CELLULOSE								
				£ STERLING	€ EUROS		£ STERLING	€ EUROS
ZZ004926	FD3-10-C10A-B-B3-D-W-VX5	1/2" BSP	25 L/MIN	£106.04	€ 119.82	D310C10A	£19.05	€ 21.52
ZZ004927	FD3-11-C10A-B-B3-D-W-VX5	1/2" BSP	40 L/MIN	£126.84	€ 143.33	D311C10A	£21.86	€ 24.70
10 MICRON FIBREGLASS								
ZZ004928	FD3-10-G10A-B-B3-D-W-VX5	1/2" BSP	20 L/MIN	£117.26	€ 132.51	D310G10A	£21.86	€ 24.70
ZZ004929	FD3-11-G10A-B-B3-D-W-VX5	1/2" BSP	25 L/MIN	£136.34	€ 154.07	D311G10A	£31.80	€ 35.94
25 MICRON FIBREGLASS								
ZZ004930	FD3-10-G25A-B-B3-D-W-VX5	1/2" BSP	25 L/MIN	£113.81	€ 128.60	D310G25A	£19.89	€ 22.47
ZZ004931	FD3-11-G25A-B-B3-D-W-VX5	1/2" BSP	30 L/MIN	£134.52	€ 152.00	D311G25A	£26.50	€ 29.95

The given flow rate values refer to applications with mineral oil having viscosity of 30 cSt at working temperature. For applications with different fluid or working conditions, a corrective factor must be applied by referring to the technical information.

INDICATORS

ORDER CODE	DESCRIPTION	NETT. PRICE	
		£ STERLING	€ EUROS
VX5	Differential Visual 5 Bar	£26.58	€ 30.04
EX5	Differential Electrical 5 Bar	£36.58	€ 40.24

INLINE MEDIUM PRESSURE FILTERS F160 UPTO 160BAR



www.flowfitonline.com
TECH. DATA SHEET
FTF12



FILTER HOUSING TECHNICAL INFORMATION

Description: In line medium pressure filter assembly with cleanable or disposable elements

Max flow rate: 400 l/min (105.5 gpm)

Max working pressure: As per NFPA T 3.10.5.1: 160 Bar (2320 psi)

Test pressure: As per NFPA T 3.10.5.1: 240 Bar (3480 psi)

Burst pressure: As per NFPA T 3.10.5.1: 480 Bar (6962 psi)

Connection Ports: BSP, NPT

By-pass: No By-pass or 6 Bar (87 psi) setting

Working temperature: -25°C + 120°C (-13°F +248°F)

Materials: •Head: Cast iron

•Bowl: Aluminium

•Seal: Buna-N / Viton®

Fluids compatibility: ISO 2943: Filter assembly compatible with mineral oils and some synthetic or vegetable oils. With other fluid applications please contact Filtrac S.p.A.

FILTER ELEMENT

Filter media: Filter element dimensions according to DIN 24550
Microglass fiber 3, 6, 10, 15, 25 µ, cellulose 10 µ

Collapse pressure: As per ISO 2941: 21 Bar (305 psi) and 210 Bar (3045 psi)

ORDER CODE	DESCRIPTION	PORTS	FLOW RATE	NETT. PRICE		ELEMENT	NETT. PRICE	
				£ STERLING	€ EUROS		£ STERLING	€ EUROS
COMPLETE WITH LOW COLLAPSE ELEMENTS, VISUAL INDICATOR AND BYPASS VALVE								
10 MICRON FIBREGLASS								
ZZ004932	F160-XD040A-G10-A-B5-D-W-V05	1" BSP	75 L/MIN	£171.01	€ 193.25	XD040G10A	£53.06	€ 59.95
ZZ004933	F160-XD063A-G10-A-B5-D-W-V05	1" BSP	90 L/MIN	£177.03	€ 200.04	XD063G10A	£55.78	€ 63.03
ZZ004934	F160-XD100A-G10-A-B5-D-W-V05	1" BSP	110 L/MIN	£188.04	€ 212.49	XD100G10A	£62.04	€ 70.11
ZZ004935	F160-XD160A-G10-A-B7-D-W-V05	1 1/2" BSP	240 L/MIN	£288.25	€ 325.72	XD160G10A	£75.55	€ 85.37
ZZ004936	F160-XD250A-G10-A-B7-D-W-V05	1 1/2" BSP	300 L/MIN	£304.86	€ 344.49	XD250G10A	£75.55	€ 85.37
ZZ004937	F160-XD400A-G10-A-B7-D-W-V05	1 1/2" BSP	340 L/MIN	£386.66	€ 436.93	XD400G10A	£136.99	€ 154.80
25 MICRON FIBREGLASS								
ZZ004938	F160-XD063A-G25-A-B3-D-W-V05	1/2" BSP	90 L/MIN	£177.03	€ 200.04	XD063G25A	£55.78	€ 63.03
ZZ004939	F160-XD063A-G25-A-B5-D-W-V05	1" BSP	100 L/MIN	£177.03	€ 200.04	XD063G25A	£55.78	€ 63.03
ZZ004940	F160-XD100A-G25-A-B5-D-W-V05	1" BSP	120 L/MIN	£188.04	€ 212.49	XD100G25A	£62.04	€ 70.11
ZZ004941	F160-XD160A-G25-A-B7-D-W-V05	1 1/2" BSP	300 L/MIN	£288.25	€ 325.72	XD160G25A	£75.55	€ 85.37
ZZ004942	F160-XD250A-G25-A-B7-D-W-V05	1 1/2" BSP	360 L/MIN	£304.86	€ 344.49	XD250G25A	£75.55	€ 85.37
ZZ004943	F160-XD400A-G25-A-B7-D-W-V05	1 1/2" BSP	380 L/MIN	£510.52	€ 576.89	XD400G25A	£136.99	€ 154.80

The given flow rate values refer to applications with mineral oil having viscosity of 30 cSt at working temperature. For applications with different fluid or working conditions, a corrective factor must be applied by referring to the technical information.

INDICATORS

ORDER CODE	DESCRIPTION	NETT. PRICE	
		£ STERLING	€ EUROS
V05	Differential Visual 5 Bar	£26.58	€ 30.04
E05	Differential Electrical 5 Bar	£36.58	€ 41.34
V08	Differential Visual 8 Bar	£26.58	€ 30.04
E08	Differential Electrical 8 Bar	£36.58	€ 41.34

FILTREC HIGH PRESSURE FILTERS

INLINE HIGH PRESSURE FILTERS F280-D1 UPTO 280BAR



www.flowfitonline.com
TECH. DATA SHEET
FTF13



FILTER HOUSING TECHNICAL INFORMATION

Description: In line high pressure filter assembly with cleanable or disposable elements

Max flow rate: 400 l/min (105 gpm)

Max working pressure: As per NFPA T 3.10.5.1: 280 Bar (4060 psi)

Test pressure: As per NFPA T 3.10.5.1: 420 Bar (6091,5 psi)

Burst pressure: As per NFPA T 3.10.5.1: 840 Bar (12180 psi)

Connection Ports: BSP, NPT, Metric

By-pass: No by-pass or 6 Bar (87 psi) setting

Working temperature: -25°C + 120°C (-13°F +248°F)

Materials:

- Head: cast iron
- Bowl: extruded steel
- Seal: Buna-N / Viton®

Fluids compatibility: ISO 2943: Filter assembly compatible with mineral oils and some synthetic or vegetable oils. With other fluid applications please contact Filtrac S.p.A.

FILTER ELEMENT

Filter media: Microglass fiber 3, 6, 10, 15, 25 µm, cellulose 10 µm

Collapse pressure: As per ISO 2941: 21 Bar (305 psi) and 210 Bar (3045 psi)

ORDER CODE	DESCRIPTION	PORTS	FLOW RATE	NETT. PRICE		ELEMENT	NETT. PRICE		
COMPLETE WITH LOW COLLAPSE ELEMENTS, VISUAL INDICATOR AND BYPASS VALVE									
				£ STERLING	€ EUROS			£ STERLING	€ EUROS
10 MICRON FIBREGLASS									
ZZ004944	F280-D120-G10-A-B-B5-D-S-V05	1" BSP	75 L/MIN	£151.01	€ 170.64	D120G10A	£36.79	€ 41.57	
ZZ004945	F280-D124-G10-A-B-B5-D-S-V05	1" BSP	90 L/MIN	£160.66	€ 181.55	D124G10A	£43.00	€ 48.59	
ZZ004946	F280-D121-G10-A-B-B5-D-S-V05	1" BSP	100 L/MIN	£168.99	€ 190.96	D121G10A	£51.29	€ 57.96	
ZZ004947	F280-D140-G10-A-B-B7-D-S-V05	1 1/2" BSP	180 L/MIN	£325.83	€ 368.18	D140G10A	£54.47	€ 61.56	
ZZ004948	F280-D141-G10-A-B-B7-D-S-V05	1 1/2" BSP	260 L/MIN	£368.41	€ 416.31	D141G10A	£74.99	€ 84.74	
ZZ004949	F280-D142-G10-A-B-B7-D-S-V05	1 1/2" BSP	320 L/MIN	£497.74	€ 562.45	D142G10A	£121.03	€ 136.77	
25 MICRON FIBREGLASS									
ZZ004950	F280-D120-G25-A-B-B5-D-S-V05	1" BSP	95 L/MIN	£142.83	€ 161.40	D120G25A	£33.78	€ 38.17	
ZZ004951	F280-D124-G25-A-B-B5-D-S-V05	1" BSP	110 L/MIN	£153.01	€ 172.90	D124G25A	£40.95	€ 46.27	
ZZ004952	F280-D121-G25-A-B-B5-D-S-V05	1" BSP	120 L/MIN	£158.68	€ 179.30	D121G25A	£45.99	€ 51.97	
ZZ004953	F280-D140-G25-A-B-B7-D-S-V05	1 1/2" BSP	240 L/MIN	£306.20	€ 346.01	D140G25A	£46.74	€ 52.81	
ZZ004954	F280-D141-G25-A-B-B7-D-S-V05	1 1/2" BSP	300 L/MIN	£350.87	€ 396.48	D141G25A	£71.42	€ 80.71	
ZZ004955	F280-D142-G25-A-B-B7-D-S-V05	1 1/2" BSP	340 L/MIN	£472.79	€ 534.26	D142G25A	£113.72	€ 128.50	

The given flow rate values refer to applications with mineral oil having viscosity of 30 cSt at working temperature. For applications with different fluid or working conditions, a corrective factor must be applied by referring to the technical information.

INDICATORS

ORDER CODE	DESCRIPTION	NETT. PRICE	
		£ STERLING	€ EUROS
V05	Differential Visual 5 Bar	£26.58	€ 30.04
E05	Differential Electrical 5 Bar	£36.58	€ 41.34
V08	Differential Visual 8 Bar	£26.58	€ 30.04
E08	Differential Electrical 8 Bar	£36.58	€ 41.34

CETOP 3 AND 5 HIGH PRESSURE FILTERS FDM-1 UPTO 315 BAR



www.flowfitonline.com
TECH. DATA SHEET
FTF14



FILTER HOUSING TECHNICAL INFORMATION

Description: Modulare in line high pressure filter assembly with cleanable or disposable elements

Max flow rate: 15/45 l/min (4/12 gpm)

Max working pressure: As per NFPA T 3.10.5.1: 315 Bar (4560 psi)

Test pressure: As per NFPA T 3.10.5.1: 400 Bar (5800 psi)

Burst pressure: As per NFPA T 3.10.5.1: 945 Bar (13700 psi)

Port connections: CETOP - 03/05

Indicator: Visual and visual electric differential indicator setting 5 and 8 bar (72,5 and 116 psi)

By-pass valve: Without

Working temperature: -25°C + 120°C (-13°F +248°F)

Materials:

- Head: steel
- Cover: steel
- Seal: Buna-N / Viton®

Fluids compatibility: ISO 2943: Filter assembly compatible with mineral oils and some synthetic or vegetable oils. With other fluid applications please contact Filtrec S.p.A.

FILTER ELEMENT

Filter element: Microglass fiber 3,6,10,25 µm
Wire mesh 10, 25 µm

Collapse pressure: As for ISO 2941: 21/210 Bar

ORDER CODE	DESCRIPTION	FLOW RATE	NETT. PRICE		ELEMENT	NETT. PRICE	
COMPLETE WITH HIGH COLLAPSE ELEMENTS, VISUAL INDICATOR AND BYPASS VALVE							
3 MICRON FIBREGLASS							
			£ STERLING	€ EUROS		£ STERLING	€ EUROS
ZZ004956	FDM-1-08-G03B-B-D-W-VX5	5 L/MIN	£188.08	€ 212.53	D108G03B	£72.75	€ 82.21
ZZ004957	FDM-1-11-G03B-B-D-W-EX5	18 L/MIN	£269.08	€ 304.06	D111G03B	£77.70	€ 87.80
6 MICRON FIBREGLASS							
ZZ004958	FDM-1-08-G06B-B-D-W-Z14	6 L/MIN	£188.08	€ 212.53	D108G06B	£72.75	€ 82.21
ZZ004959	FDM-1-11-G06B-B-D-W-Z15	25 L/MIN	£269.08	€ 304.06	D111G06B	£77.70	€ 87.80
10 MICRON FIBREGLASS							
ZZ004960	FDM-1-08-G10B-B-D-W-Z16	7 L/MIN	£178.80	€ 202.05	D108G10B	£59.45	€ 67.18
ZZ004961	FDM-1-11-G10B-B-D-W-VX8	31 L/MIN	£257.09	€ 290.51	D111G10B	£60.47	€ 68.33

The given flow rate values refer to applications with mineral oil having viscosity of 30 cSt at working temperature. For applications with different fluid or working conditions, a corrective factor must be applied by referring to the technical information.

OPTIONAL EXTRAS

VITON SEALS	NETT. PRICE	
	£ STERLING	€ EUROS
FDM-1-08	£12.40	€ 14.01
FDM-1-11	£15.91	€ 17.98

INDICATORS

ORDER CODE	DESCRIPTION	NETT. PRICE	
		£ STERLING	€ EUROS
VX5	Differential Visual 5 Bar	£26.58	€ 30.04
EX5	Differential Electrical 5 Bar	£36.58	€ 41.34
VX8	Differential Visual 8 Bar	£26.58	€ 30.04
EX8	Differential Electrical 8 Bar	£36.58	€ 41.34

INLINE HIGH PRESSURE FILTERS F420-D1 SERIES



www.flowfitonline.com
TECH. DATA SHEET
FTF15



TECHNICAL INFORMATION

Pressure: Max working 420 bar (6000 psi) (acc. to NFPA T 3.10.5.1)
Burst 1260 bar (18300 psi) (acc. to NFPA T 3.10.5.1)

Connection Ports: 1/2"+1 1/2" BSP (other thread options on request)
3/4"+1 1/2" SAE J518-6000

Materials: Head: cast iron Bowl: extruded steel Seal: Buna-N (FKM on request)

By-pass: No by-pass or 6 bar (90 psi) setting

Filter Media: Microglass fiber 4,5 – 7 – 12 – 18 – 27 µm(c) (acc. to ISO 16889)
Cellulose 10 - 25 µm(c) (acc. to ISO 16889)

Differential collapse pressure: 21 bar (300 psi) or 210 bar (3000 psi) (acc. to ISO 2941)
The Filtrtec elements are tested also according to ISO 2942 and ISO 23181

Working temperature: -25°C +120°C (-13°F +248°F)

Fluid compatibility (acc. to ISO 2943): Full with HH-HL-HM-HV (acc. to ISO 6743/4).

CODE	DESCRIPTION	PORTS	MAX PRESSURE	FLOW RATE	NETT. PRICE		ELEMENT	NETT. PRICE	
					£ STERLING	€ EUROS		£ STERLING	€ EUROS
3 MICRON FIBREGLASS									
ZZ005634	F420-D1-10-G03-A-B-B3-D-T-V05	1/2"	420 BAR	10 L/MIN	£145.37	€ 164.27	D110G03A	£31.67	€ 35.78
ZZ005638	F420-D1-10-G03-A-B-B4-D-T-V05	3/4"	420 BAR	12 L/MIN	£139.10	€ 157.19	D110G03A	£31.67	€ 35.78
ZZ005642	F420-D1-11-G03-A-B-B3-D-T-V05	1/2"	420 BAR	15 L/MIN	£158.41	€ 179.01	D111G03A	£29.05	€ 32.83
ZZ005647	F420-D1-11-G03-A-B-B4-D-T-V05	3/4"	420 BAR	18 L/MIN	£158.93	€ 179.59	D111G03A	£29.05	€ 32.83
ZZ005654	F420-D1-12-G03-A-B-B4-D-T-V05	3/4"	420 BAR	35 L/MIN	£179.95	€ 203.34	D112G03A	£48.95	€ 55.31
ZZ005658	F420-D1-12-G03-A-B-B3-D-T-V05	1/2"	420 BAR	30 L/MIN	£175.07	€ 197.83	D112G03A	£48.95	€ 55.31
ZZ005662	F420-D1-20-G03-A-B-B4-D-T-V05	3/4"	420 BAR	30 L/MIN	£194.39	€ 219.66	D120G03A	£41.72	€ 47.14
ZZ005668	F420-D1-20-G03-A-B-B5-D-T-V05	1"	420 BAR	30 L/MIN	£178.24	€ 201.41	D120G03A	£41.72	€ 47.14
ZZ006605	F420-D1-40-G03-A-B-B5-D-T-V05	1"	420 BAR	50 L/MIN	£281.62	€ 318.23	D140G03A	£57.10	€ 64.52
ZZ006609	F420-D1-40-G03-A-B-B6-D-T-V05	1 1/4"	420 BAR	65 L/MIN	£308.98	€ 349.15	D140G03A	£57.10	€ 64.52
ZZ006613	F420-D1-40-G03-A-B-B7-D-T-V05	1 1/2"	420 BAR	65 L/MIN	£320.57	€ 362.24	D140G03A	£57.10	€ 64.52
6 MICRON FIBREGLASS									
ZZ005635	F420-D1-10-G06-A-B-B3-D-T-V05	1/2"	420 BAR	20 L/MIN	£147.26	€ 166.41	D110G06A	£31.67	€ 35.78
ZZ005639	F420-D1-10-G06-A-B-B4-D-T-V05	3/4"	420 BAR	20 L/MIN	£141.02	€ 159.35	D110G06A	£31.67	€ 35.78
ZZ005643	F420-D1-11-G06-A-B-B3-D-T-V05	1/2"	420 BAR	25 L/MIN	£159.33	€ 180.04	D111G06A	£29.05	€ 32.83
ZZ005651	F420-D1-11-G06-A-B-B4-D-T-V05	3/4"	420 BAR	30 L/MIN	£159.83	€ 180.61	D111G06A	£29.05	€ 32.83
ZZ005655	F420-D1-12-G06-A-B-B4-D-T-V05	3/4"	420 BAR	55 L/MIN	£175.44	€ 198.25	D112G06A	£48.95	€ 55.31
ZZ005659	F420-D1-12-G06-A-B-B3-D-T-V05	1/2"	420 BAR	50 L/MIN	£166.97	€ 188.68	D112G06A	£48.95	€ 55.31
ZZ005663	F420-D1-20-G06-A-B-B4-D-T-V05	3/4"	420 BAR	50 L/MIN	£191.73	€ 216.65	D120G06A	£36.18	€ 40.89
ZZ005669	F420-D1-20-G06-A-B-B5-D-T-V05	1"	420 BAR	55 L/MIN	£175.57	€ 198.39	D120G06A	£36.18	€ 40.89
ZZ006606	F420-D1-40-G06-A-B-B5-D-T-V05	1"	420 BAR	80 L/MIN	£275.16	€ 310.93	D140G06A	£57.10	€ 64.52
ZZ006610	F420-D1-40-G06-A-B-B6-D-T-V05	1 1/4"	420 BAR	115 L/MIN	£302.53	€ 341.85	D140G06A	£57.10	€ 64.52
ZZ006614	F420-D1-40-G06-A-B-B7-D-T-V05	1 1/2"	420 BAR	125 L/MIN	£314.09	€ 354.92	D140G06A	£57.10	€ 64.52
10 MICRON FIBREGLASS									
ZZ005636	F420-D1-10-G10-A-B-B3-D-T-V05	1/2"	420 BAR	35 L/MIN	£147.07	€ 166.19	D110G10A	£31.31	€ 35.38
ZZ005640	F420-D1-10-G10-A-B-B4-D-T-V05	3/4"	420 BAR	40 L/MIN	£140.83	€ 159.13	D110G10A	£31.31	€ 35.38
ZZ005644	F420-D1-11-G10-A-B-B3-D-T-V05	1/2"	420 BAR	40 L/MIN	£161.61	€ 182.61	D111G10A	£29.05	€ 32.83
ZZ005652	F420-D1-11-G10-A-B-B4-D-T-V05	3/4"	420 BAR	45 L/MIN	£161.53	€ 182.53	D111G10A	£29.05	€ 32.83
ZZ005656	F420-D1-12-G10-A-B-B4-D-T-V05	3/4"	420 BAR	75 L/MIN	£172.41	€ 194.82	D112G10A	£44.18	€ 49.93
ZZ005660	F420-D1-12-G10-A-B-B3-D-T-V05	1/2"	420 BAR	60 L/MIN	£167.38	€ 189.14	D112G10A	£44.18	€ 49.93
ZZ005664	F420-D1-20-G10-A-B-B4-D-T-V05	3/4"	420 BAR	70 L/MIN	£183.18	€ 207.00	D120G10A	£36.79	€ 41.57
ZZ005670	F420-D1-20-G10-A-B-B5-D-T-V05	1"	420 BAR	80 L/MIN	£167.01	€ 188.72	D120G10A	£36.79	€ 41.57
ZZ006607	F420-D1-40-G10-A-B-B5-D-T-V05	1"	420 BAR	110 L/MIN	£269.35	€ 304.36	D140G10A	£54.47	€ 61.56
ZZ006611	F420-D1-40-G10-A-B-B6-D-T-V05	1 1/4"	420 BAR	160 L/MIN	£296.70	€ 335.27	D140G10A	£54.47	€ 61.56
ZZ006615	F420-D1-40-G10-A-B-B7-D-T-V05	1 1/2"	420 BAR	180 L/MIN	£308.27	€ 348.34	D140G10A	£56.72	€ 64.09
25 MICRON FIBREGLASS									
ZZ005637	F420-D1-10-G25-A-B-B3-D-T-V05	1/2"	420 BAR	50 L/MIN	£141.68	€ 160.09	D110G25A	£25.32	€ 28.61
ZZ005641	F420-D1-10-G25-A-B-B4-D-T-V05	3/4"	420 BAR	60 L/MIN	£141.50	€ 159.89	D110G25A	£25.32	€ 28.61
ZZ005645	F420-D1-11-G25-A-B-B3-D-T-V05	1/2"	420 BAR	60 L/MIN	£157.36	€ 177.82	D111G25A	£27.57	€ 31.16
ZZ005653	F420-D1-11-G25-A-B-B4-D-T-V05	3/4"	420 BAR	70 L/MIN	£158.90	€ 179.55	D111G25A	£27.57	€ 31.16
ZZ005657	F420-D1-12-G25-A-B-B4-D-T-V05	3/4"	420 BAR	100 L/MIN	£169.87	€ 191.95	D112G25A	£39.91	€ 45.10
ZZ005661	F420-D1-12-G25-A-B-B3-D-T-V05	1/2"	420 BAR	70 L/MIN	£161.43	€ 182.41	D112G25A	£39.91	€ 45.10
ZZ005665	F420-D1-20-G25-A-B-B4-D-T-V05	3/4"	420 BAR	95 L/MIN	£185.47	€ 209.58	D120G25A	£35.47	€ 40.08
ZZ006604	F420-D1-20-G25-A-B-B5-D-T-V05	1"	420 BAR	105 L/MIN	£169.32	€ 191.33	D120G25A	£35.47	€ 40.08
ZZ006608	F420-D1-40-G25-A-B-B5-D-T-V05	1"	420 BAR	140 L/MIN	£271.23	€ 306.48	D140G25A	£49.08	€ 55.46
ZZ006612	F420-D1-40-G25-A-B-B6-D-T-V05	1 1/4"	420 BAR	245 L/MIN	£298.58	€ 337.39	D140G25A	£49.08	€ 55.46
ZZ006616	F420-D1-40-G25-A-B-B7-D-T-V05	1 1/2"	420 BAR	260 L/MIN	£310.23	€ 350.56	D140G25A	£49.08	€ 55.46

INDICATORS

ORDER CODE	DESCRIPTION	NETT. PRICE	
		£ STERLING	€ EUROS
V05	Differential Visual 5 Bar	£26.58	€ 30.04
E05	Differential Electrical 5 Bar	£36.58	€ 41.34
V08	Differential Visual 8 Bar	£26.58	€ 30.04
E08	Differential Electrical 8 Bar	£36.58	€ 41.34

FILTREC ACCESSORIES

PRODUCT	PAGE
CLOGGING INDICATORS	549
ELECTRIC LEVEL INDICATORS	553
ELECTRIC FLOATING LEVEL GAUGES	555
SIGHT GLASSES, PLUGS AND BREATHERS	562



QUALITY PRODUCTS



FREE ADVICE



CLOGGING INDICATORS

www.flowfitonline.com
TECH. DATA SHEET
FA01



TECHNICAL INFORMATION

Clogging indicators controlling and determining the moment when filter change should take place are available for the entire FILTREC assembly range.

ABSOLUTE pressure indicators

They measure the pressure in the filter vs the atmospheric one. Usually they are used on return line filters discharging in tank.

Clogging indicators

- **Visual:** The indicator is provided with a bar and a psi scale. The pointer indicates clog value.
- **Electrical:** Electrical signal indicates clog value. It is used in hard to reach areas, the signal is visible on a control panel through a led.

DIFFERENTIAL pressure indicators

Differential pressure indicators measure the difference in pressure between the dirty and the clean side of the filter. They are not affected by atmospheric pressure. Usually they are used on pressure and return line filters.

Clogging indicators:

- **Visual:** A colored indicator reports when pressure setting is reached:
GREEN = differential pressure minor than setting value
RED = differential pressure major than setting value
- **Electrical:** An electrical signal indicates when admissible differential pressure is reached. It is used in hard to reach areas, the signal is visible on a control panel through a luminous led.
- **Visual Electrical:** Both colored indicator and electrical signal indicate when pressure setting is reached.

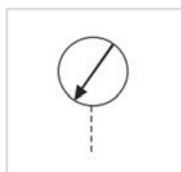
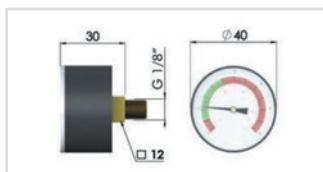

Code	Setting
MPA	-1 ÷ 5 bar (black color) - 14,5 ÷ 72,5 psi (red color)



ORDER CODE	DESCRIPTION	SETTING	THREAD	NETT. PRICE				
MPA	PRESURE VACUUM GAUGE	-1 TO 5BAR (BLACK) 14.5 TO 72.5 PSI (RED)	1/8" BSP	<table border="0"> <tr> <td>£ STERLING</td> <td>€ EUROS</td> </tr> <tr> <td>£5.43</td> <td>€ 6.14</td> </tr> </table>	£ STERLING	€ EUROS	£5.43	€ 6.14
£ STERLING	€ EUROS							
£5.43	€ 6.14							

VACUUM GAUGE

Housing in black ABS material

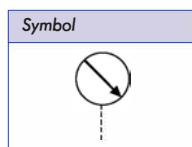
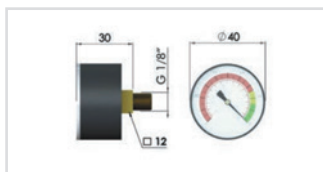

Code	Setting
MPS	0 ÷ -1 bar (black color) 0 ÷ - 14,5 psi (red color)



ORDER CODE	DESCRIPTION	SETTING	THREAD	NETT. PRICE				
MPS	VACUUM GAUGE	0 TO -1 BAR (BLACK) 0 TO 114.5 PSI (RED)	1/8" BSP	<table border="0"> <tr> <td>£ STERLING</td> <td>€ EUROS</td> </tr> <tr> <td>£7.90</td> <td>€ 8.93</td> </tr> </table>	£ STERLING	€ EUROS	£7.90	€ 8.93
£ STERLING	€ EUROS							
£7.90	€ 8.93							

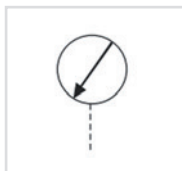
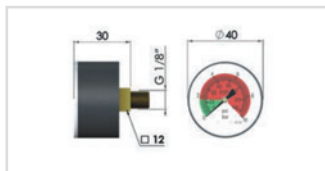

ORDER CODE	DESCRIPTION	SETTING	THREAD	NETT. PRICE	
				£ STERLING	€ EUROS
MPB	Pressure Gauge	1,7 ÷ 10 Bar (Red), 0 ÷ 1,7 Bar (Green)	1/8" BSP	£4.08	€ 4.61

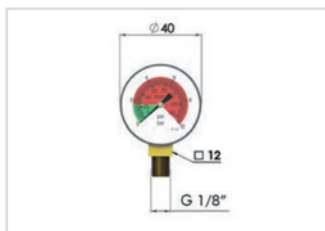

ORDER CODE	DESCRIPTION	SETTING	THREAD	NETT. PRICE	
				£ STERLING	€ EUROS
MRB	Pressure Gauge	1,7 ÷ 10 Bar (Red), 0 ÷ 1,7 Bar (Green)	1/8" BSP	£3.68	€ 4.16

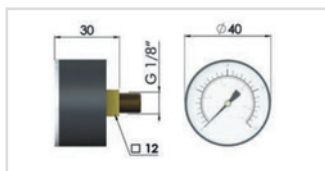

ORDER CODE	DESCRIPTION	SETTING	THREAD	NETT. PRICE	
				£ STERLING	€ EUROS
MP0	Pressure Gauge	0 ÷ 16 Bar	1/8" BSP	£4.28	€ 4.84

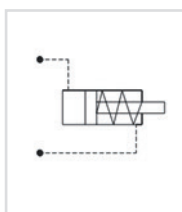
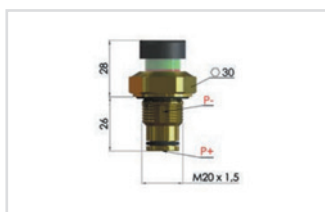

ORDER CODE	DESCRIPTION	SETTING	THREAD	NETT. PRICE	
				£ STERLING	€ EUROS
V02	Differential Visual	2,7 Bar	M20 x 1,5	£26.58	€ 30.04
V05	Differential Visual	5 Bar	M20 x 1,5	£26.58	€ 30.04
V08	Differential Visual	8 Bar	M20 x 1,5	£26.58	€ 30.04

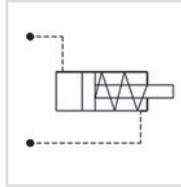
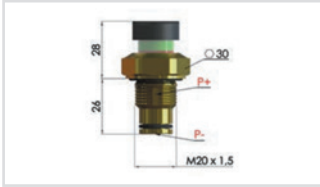

ORDER CODE	DESCRIPTION	SETTING	THREAD	NETT. PRICE	
				£ STERLING	€ EUROS
VX5	Differential Visual	5 Bar	M20 x 1,5	£26.58	€ 30.04
VX8	Differential Visual	8 Bar	M20 x 1,5	£26.58	€ 30.04

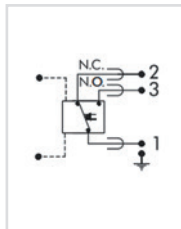
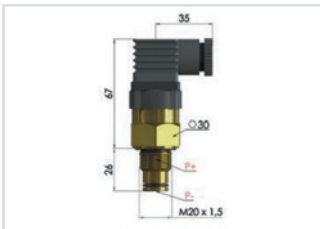

ORDER CODE	DESCRIPTION	SETTING	THREAD	NETT. PRICE	
				£ STERLING	€ EUROS
EX5	Differential Electric	5 Bar	M20 x 1,5	£36.58	€ 41.34
EX8	Differential Electric	8 Bar	M20 x 1,5	£36.58	€ 41.34

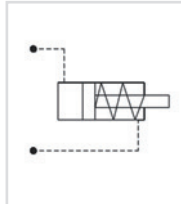

ORDER CODE	DESCRIPTION	SETTING	THREAD	NETT. PRICE	
				£ STERLING	€ EUROS
Z34	Differential Visual	2,7 Bar	M18 x 1,5	£20.66	€ 23.35

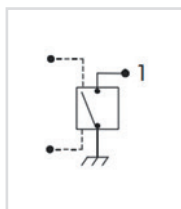
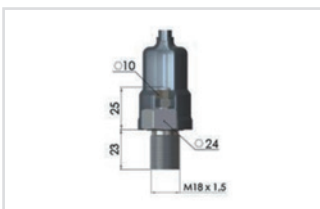

ORDER CODE	DESCRIPTION	SETTING	THREAD	NETT. PRICE	
				£ STERLING	€ EUROS
Z35	Differential Electric	2,7 Bar	M18 x 1,5	£20.66	€ 23.36

SERIE FL - FLUID LEVEL TEMPERATURE GAUGES



www.flowfitonline.com
TECH. DATA SHEET
FA02

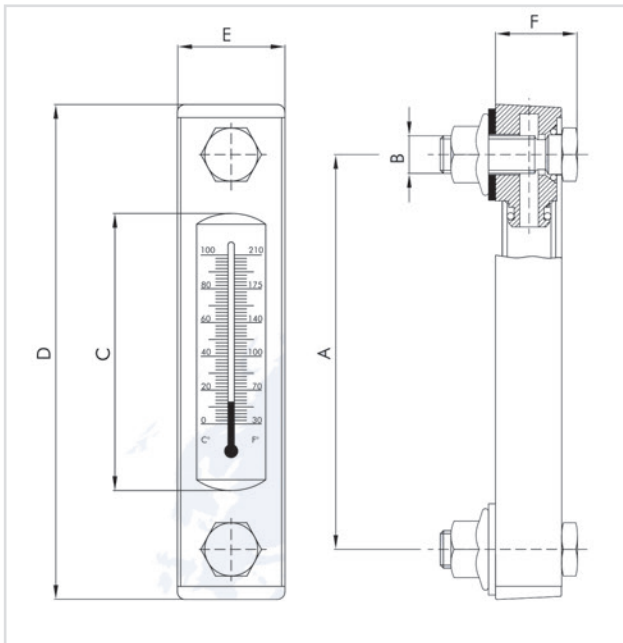
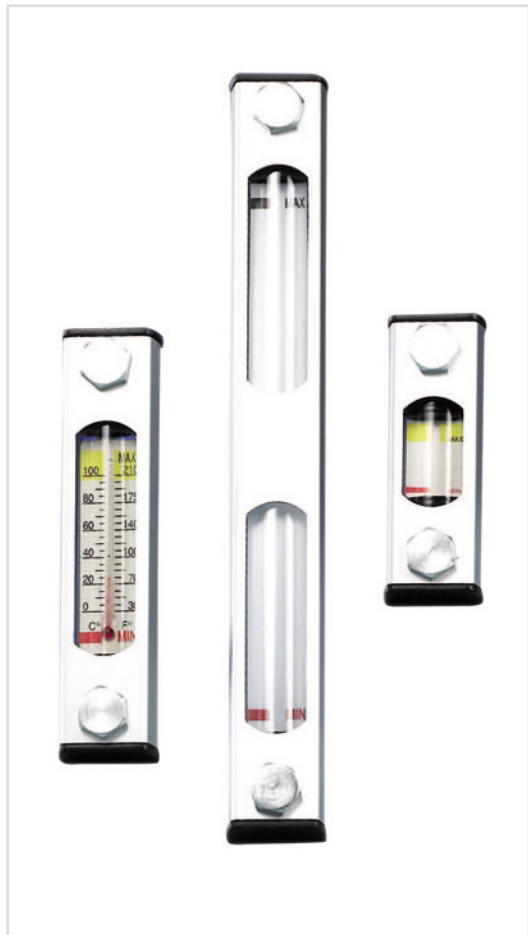

Technical Information

Description: Fluid level temperature gauges

Max working pressure: 1 Bar (14.5 psi)

Connection Ports: Metric

Working temperature: -20°C +80°C (-4°F +1 76°F)

Thermometer: Double scale 0°C + 100°C 30°F + 210 °F

Materials:

- Heads: nylon
- Protection: anodized aluminium
- Screws: zinc steel
- Seal: Buna-N compatible as per ISO 2943 with mineral oil (HH-HL-HM-HR-HV-HG) water oil emulsions (HFAE-HFAS)

CODE	A	B	C	D	E	F
FL-1	76	M10	35	106	36	30
FL-2	127		86	157	36	30
FL-3	254	M12	213	284	36	30

ORDER CODE	HOLE CENTRES	BOLT THREAD SIZE	NETT. PRICE	
			£ STERLING	€ EUROS
FL1M10	76mm	M10x1.5	£9.25	€ 10.45
FL1M12	76mm	M12x1.75	£9.25	€ 10.45
FL1TM10	76mm	M10x1.5	£9.40	€ 10.62
FL1TM12	76mm	M12x1.75	£10.26	€ 11.59
FL2M10	127mm	M10x1.5	£10.15	€ 11.47
FL2M12	127mm	M12x1.75	£10.15	€ 11.47
FL2TM10	127mm	M10x1.5	£10.80	€ 12.21
FL2TM12	127mm	M12x1.75	£10.80	€ 12.21
FL3M10	254mm	M10x1.5	£16.13	€ 18.22
FL3M12	254mm	M12x1.75	£16.13	€ 18.22
FL3TM10	254mm	M10x1.5	£18.39	€ 20.78
FL3TM12	254mm	M12x1.75	£18.39	€ 20.78

ELECTRIC LEVEL INDICATORS

FLOATING LEVEL GAUGE BSP AND 3 HOLE MOUNT

www.flowfitonline.com
TECH. DATA SHEET
FA03

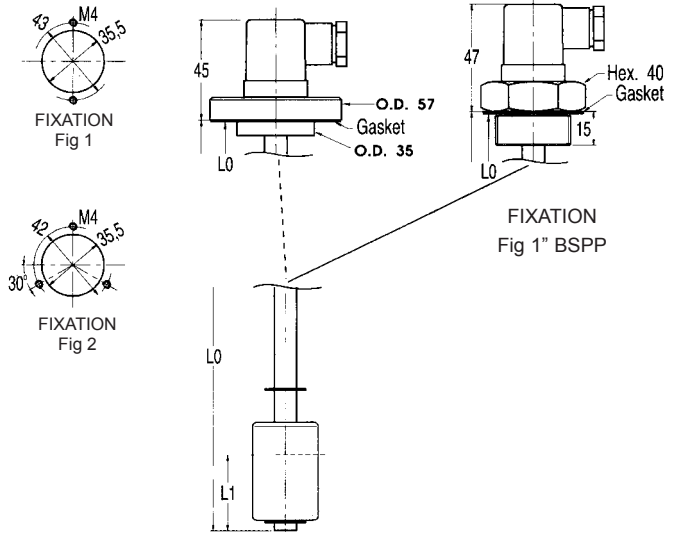

Tank-top mounted they give an electrical signal when the minimum fluid level is reached. They are always supplied with open contacts.

With just one contact you have both possible electric connections normally open or normally closed.

- Min or min/max level monitoring
- Compatible with mineral oils, oil-water emulsions, diesel and water
- Unsinkable floater
- Electric contact hermetically sealed inside the floater rod
- Flanged or nut type fixation to tank cover

VOLTAGE

All voltages DC/AC up to 240V

MAX CURRENT

220V, 60W, 60VA, A1

TEMPERATURE RANGE

-10 to +80°C

MAX PRESSURE

12 Bar

Electric connections

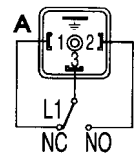

ORDER JUST THE ONE AND YOU HAVE ALL THREE FIXING POINTS IN ONE LEVEL GAUGE

PART NUMBER	LENGTH (L0)	NETT. PRICE	
		£ STERLING	€ EUROS
FLG100	100mm	£73.24	€ 82.76
FLG150	150mm	£75.37	€ 85.17
FLG200	200mm	£77.03	€ 87.04
FLG250	250mm	£78.52	€ 88.73
FLG300	300mm	£80.66	€ 91.15
FLG350	350mm	£80.66	€ 91.15
FLG400	400mm	£84.16	€ 95.10
FLG450	450mm	£84.16	€ 95.10
FLG550	500mm	£113.02	€ 127.71

ELECTRIC FLOAT LEVEL SWITCHES 2 HOLE MOUNT

www.flowfitonline.com
TECH. DATA SHEET
FA03

LM1CFPA... LM2CFPA...

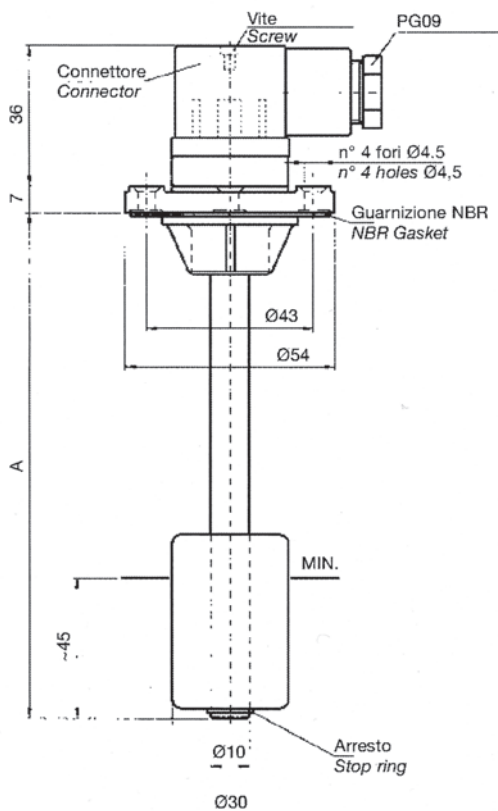

Collegamenti elettrici standard
Standard electrical connection

LM1CFPA

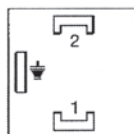

Material: Flange in thermoplastic, brass stem, stop rings in bronze, NBR float.

NB: Customized lengths can be supplied on request. Max length 1500mm

Executions also available in accordance with the Directive ATEX 94//9/EC on intrinsic safety equipment with marking II 1/2 G Ex ia IIB T6.

PART NUMBER	LENGTH (A)	NETT. PRICE	
		£ STERLING	€ EUROS
LM1CFPA100	100	£64.59	€ 72.98
LM1CFPA150	150	£66.47	€ 75.11
LM1CFPA200	200	£68.03	€ 76.87
LM1CFPA250	250	£135.51	€ 153.13
LM1CFPA300	300	£71.14	€ 80.39
LM1CFPA350	350	£71.14	€ 80.39
LM1CFPA400	400	£74.22	€ 83.87
LM1CFPA450	450	£74.22	€ 83.87
LM1CFPA500	500	£78.23	€ 88.39

SERIE NS 2 WITH 2 SWITCH CONTACTS

www.flowfitonline.com
TECH. DATA SHEET
FA03

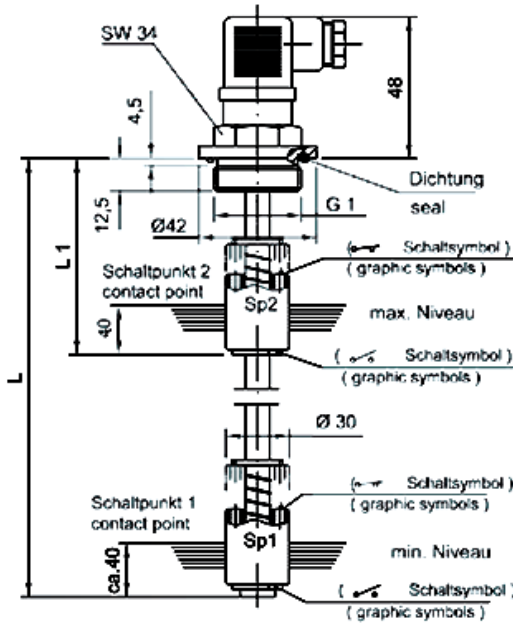

DESCRIPTION

- Electrical level supervision
- Appropriate for mineral oil, diesel and benzine
- 2 switch contacts
- Electrical circuit for level, min/max
- Standard version level max = contact open

TECHNICAL DATA

- Stem: Brass
- Float: Nylon
- Max. Temp: 80° C
- Protection: IP 65
- Hysteresis: 2-3 mm
- Max voltage: 250 VAC
- Max. Schaltstrom / Max switch current: Level 1.3 A
- Power AC/DC Level: 80 W/WA

Sp 1
contact open with max. level



Sp 2
contact open with max. level



By turning the float the contact is changed to:
max. level - contact closed
min. level contact open

contact closed with min. level



contact closed with min. level

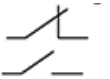

PART NUMBER	TYPE	L	L ₁	NETT. PRICE	
				£ STERLING	€ EUROS
FLG 1457	NS 2-NO/250/105	250	105	£170.28	€ 192.41
FLG1459	NS 2-NO/300/ 105	300	105	£170.28	€ 192.41
FLG1461	NS 2-NO/350/115	350	115	£170.28	€ 192.41
FLG1463	NS 2-NO/400/115	400	115	£176.85	€ 199.84
FLG 1465	NS 2-NO/500/ 125	500	125	£176.85	€ 199.84

**FOR SALES
& ADVICE
CALL US
01584
876033**

SERIE FB - 1 AIR BREATHER FILTERS



www.flowfitonline.com
TECH. DATA SHEET
FA04

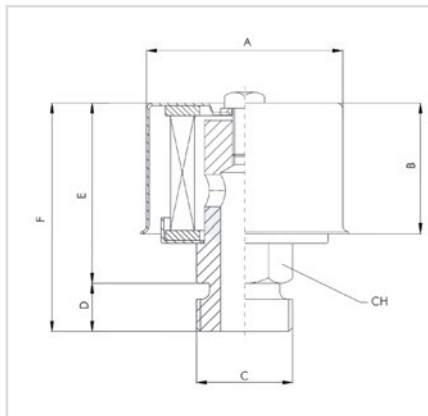

Technical Information

Description: Thread air breather filters.
Max flow rate: FB1-10 200 l/min. (53 gpm)
FB1-20 500 l/min. (132 gpm)
FB1-20 1000 l/min. (264 gpm)

Port Connection: BSP — Metric

Materials: Zinc Steel

CODE	A	B	V	D	E	F	CH
FB-1-10	48	32	B1	9	45	54	14
	48	32	B2	9	45	54	19
	48	32	M12	9	45	54	14
	48	32	M16	9	45	54	19
	48	32	M18	9	45	54	19
	48	32	M22	10	45	55	24
FB-1-20	67	50	B3	10	59	69	27
	67	50	B4	10	59	69	27
	67	50	M16	10	59	69	27
FB-1-30	108	61	B5	15	76	91	34

ORDER CODE	THREAD	LENGTH	O/D	MICRON	AIRFLOW	NETT. PRICE	
						£ STERLING	€ EUROS
FB110B1C05	1/4" BSP	54mm	48mm	5 MICRON	200 L/MIN	£8.33	€ 9.41
FB110B1C10	1/4" BSP	54mm	48mm	10 MICRON	200 L/MIN	£8.33	€ 9.41
FB110B1C40	1/4" BSP	54mm	48mm	40 MICRON	200 L/MIN	£8.63	€ 9.75
FB110B2C05	3/8" BSP	54mm	48mm	5 MICRON	200 L/MIN	£9.00	€ 10.17
FB110B2C10	3/8" BSP	54mm	48mm	10 MICRON	200 L/MIN	£9.00	€ 10.17
FB110B2C40	3/8" BSP	54mm	48mm	40 MICRON	200 L/MIN	£9.39	€ 10.61
FB120B3C05	1/2" BSP	69mm	67mm	5 MICRON	500 L/MIN	£12.33	€ 13.93
FB120B3C10	1/2" BSP	69mm	67mm	10 MICRON	500 L/MIN	£11.63	€ 13.15
FB120B3C40	1/2" BSP	69mm	67mm	40 MICRON	500 L/MIN	£12.00	€ 13.56
FB120B4C05	3/4" BSP	69mm	67mm	5 MICRON	500 L/MIN	£17.07	€ 19.29
FB120B4C10	3/4" BSP	69mm	67mm	10 MICRON	500 L/MIN	£18.10	€ 20.46
FB120B4C40	3/4" BSP	69mm	67mm	40 MICRON	500 L/MIN	£17.44	€ 19.71
FB130B5C05	1" BSP	91mm	108mm	5 MICRON	1000 L/MIN	£16.13	€ 18.22
FB130B5C10	1" BSP	91mm	108mm	10 MICRON	1000 L/MIN	£16.13	€ 18.22
FB130B5C40	1" BSP	91mm	108mm	40 MICRON	1000 L/MIN	£17.66	€ 19.96

SERIE FT FILLER BREATHER FILTERS



www.flowfitonline.com
TECH. DATA SHEET
FA05



Technical Information

Description: Filler breathers filters

Filter media: Cellulose 10, 40p

Max flow rate: •FT-5 200 l/min (53 gpm)
•FT-7 and FT-8 500 l/min (132 gpm)

Basket: 500p

Chain: FT-8-../1 and FT-8-../2 are equipped with a connection chain between cap and flange.

Materials: •Cap: chrome plated steel

•Basket: zinc steel

•Flange: zinc steel

•Gasket: cork

CODE	B1	D1	H1	H2	L1	L2	L3	AIR FLOW RATE L/MIN DP 0.015 BARG	
								F03	F10
FT5	41	31	37	67	52	48	27.5	200	250
FT8 S8				80					
FT8 S15	71÷73	52	50	150	83	75	50	450	550
FT8S10		40		105			38		
FT8 W10	40			---	83			200	250
FT8 T13	62	50	105	130	60	75	38	450	550

CODE	A	H1	H2	L1	M	AIR FLOW RATE L/MIN DP 0.015 BARG	
						F03	F10
FT6...B1	1/4" BSP	27	31	48	22	250	250
FT6...B2	3/8" BSP						
FT7...B3	1/2" BSP	27	35.5	75	27	450	550
FT7...B4	3/4" BSP						

OVERALL DIMENSIONS

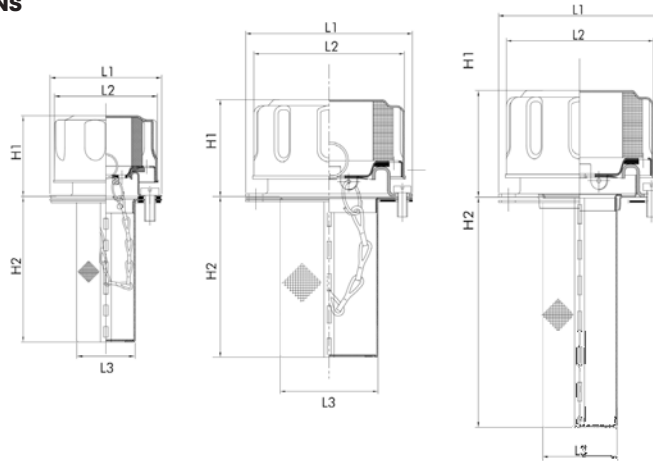

TANK HOLE DIMENSIONS

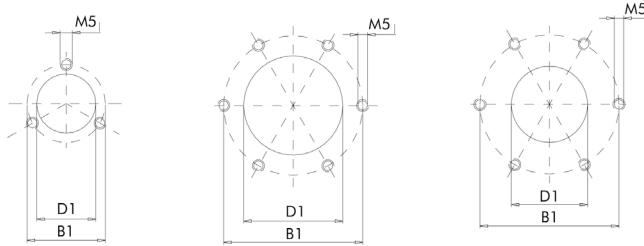

OVERALL DIMENSIONS

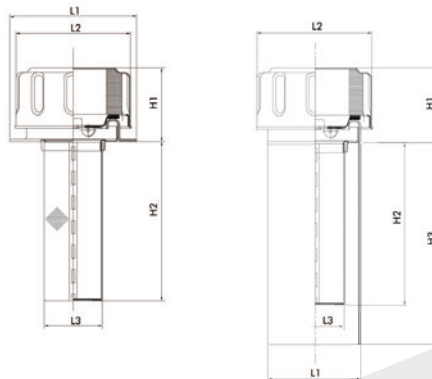

TANK HOLE DIMENSIONS





STANDARD AND PRESSURISED FILLER BREATHERS



STANDARD AND PRESSURISED FILLER LOCKABLE

ORDER CODE	OUTER DIAMETER	TOTAL LENGTH	WIDTH OF BASKET	LENGTH OF BASKET	MOUNTING	AIR RATING INNER ELEMENT	PRESSURISED RATING	NETT. PRICE	
								£ STERLING	€ EUROS
STANDARD FILLER BREATHERS									
FT5F03B	52mm	104mm	27.5mm	67mm	FT5 Only	3 Micron	No Pressure Valve	£8.77	€ 9.91
FT5F10B	52mm	104mm	27.5mm	67mm	FT5 Only	10 Micron	No Pressure Valve	£8.77	€ 9.91
FT8F03BS0800	83mm	130mm	50mm	80mm	Flange & Basket	3 Micron	No Pressure Valve	£9.87	€ 11.15
FT8F03BS1500	83mm	200mm	50mm	150mm	Flange & Basket	3 Micron	No Pressure Valve	£9.83	€ 11.11
FT8F03BS1000	83mm	155mm	38mm	105mm	Flange & Removable Basket	3 Micron	No Pressure Valve	£8.16	€ 9.22
FT8F03BW1000	83mm	155mm	38mm	105mm	Welding Flange	3 Micron	No Pressure Valve	£9.09	€ 10.28
FT8F03BT1300	60mm	155mm	38mm	105mm	With Antisplash Tube	3 Micron	No Pressure Valve	£31.72	€ 35.84
FT8F10BS0800	83mm	130mm	50mm	80mm	Flange & Basket	10 Micron	No Pressure Valve	£9.87	€ 11.15
FT8F10BS1500	83mm	200mm	50mm	150mm	Flange & Basket	10 Micron	No Pressure Valve	£9.23	€ 10.43
FT8F10BS1000	83mm	155mm	38mm	105mm	Flange & Removable Basket	10 Micron	No Pressure Valve	£8.37	€ 9.46
FT8F10BW1000	83mm	155mm	38mm	105mm	Welding Flange	10 Micron	No Pressure Valve	£8.76	€ 9.90
FT8F10BT1300	60mm	155mm	38mm	105mm	With Antisplash Tube	10 Micron	No Pressure Valve	£30.77	€ 34.76
STANDARD LOCKABLE FILLER BREATHERS									
FT8F03BS080L	83mm	130mm	50mm	80mm	Flange & Basket	3 Micron	No Pressure Valve	£14.99	€ 16.94
FT8F03BS150L	83mm	200mm	50mm	150mm	Flange & Basket	3 Micron	No Pressure Valve	£15.59	€ 17.62
FT8F03BS100L	83mm	155mm	38mm	105mm	Flange & Removable Basket	3 Micron	No Pressure Valve	£13.92	€ 15.73
FT8F03BW100L	83mm	155mm	38mm	105mm	Welding Flange	3 Micron	No Pressure Valve	£14.86	€ 16.79
FT8F10BS080L	83mm	130mm	50mm	80mm	Flange & Basket	10 Micron	No Pressure Valve	£14.19	€ 16.03
FT8F10BS150L	83mm	200mm	50mm	150mm	Flange & Basket	10 Micron	No Pressure Valve	£14.99	€ 16.94
FT8F10BS100L	83mm	155mm	38mm	105mm	Flange & Removable Basket	10 Micron	No Pressure Valve	£14.13	€ 15.97
FT8F10BW100L	83mm	155mm	38mm	105mm	Welding Flange	10 Micron	No Pressure Valve	£14.52	€ 16.41
PRESSURISED FILLER BREATHERS									
FT8F03BS0810	83mm	130mm	50mm	80mm	Flange & Basket	3 Micron	0.35 Bar / 5 PSI	£24.27	€ 27.42
FT8F03BS1510	83mm	200mm	50mm	150mm	Flange & Basket	3 Micron	0.35 Bar / 5 PSI	£24.86	€ 28.10
FT8F03BS1010	83mm	155mm	38mm	105mm	Flange & Removable Basket	3 Micron	0.35 Bar / 5 PSI	£23.18	€ 26.20
FT8F03BW1010	83mm	155mm	38mm	105mm	Welding Flange	3 Micron	0.35 Bar / 5 PSI	£24.13	€ 27.27
FT8F03BT1310	60mm	155mm	38mm	105mm	With Antisplash Tube	3 Micron	0.35 Bar / 5 PSI	£46.76	€ 52.83
FT8F10BS0810	83mm	130mm	50mm	80mm	Flange & Basket	10 Micron	0.35 Bar / 5 PSI	£23.46	€ 26.51
FT8F10BS1510	83mm	200mm	50mm	150mm	Flange & Basket	10 Micron	0.35 Bar / 5 PSI	£24.27	€ 27.42
FT8F10BS1010	83mm	155mm	38mm	105mm	Flange & Removable Basket	10 Micron	0.35 Bar / 5 PSI	£23.39	€ 26.44
FT8F10BW1010	83mm	155mm	38mm	105mm	Welding Flange	10 Micron	0.35 Bar / 5 PSI	£23.78	€ 26.87
FT8F10BT1310	60mm	155mm	38mm	105mm	With Antisplash Tube	10 Micron	0.35 Bar / 5 PSI	£45.80	€ 51.76
FT8F03BS0820	83mm	130mm	50mm	80mm	Flange & Basket	3 Micron	0.75 Bar / 10.8 PSI	£24.27	€ 27.42
FT8F03BS1520	83mm	200mm	50mm	150mm	Flange & Basket	3 Micron	0.75 Bar / 10.8 PSI	£24.86	€ 28.10
FT8F03BS1020	83mm	155mm	38mm	105mm	Flange & Removable Basket	3 Micron	0.75 Bar / 10.8 PSI	£23.18	€ 26.20
FT8F03BW1020	83mm	155mm	38mm	105mm	Welding Flange	3 Micron	0.75 Bar / 10.8 PSI	£24.13	€ 27.27
FT8F03BT1320	60mm	155mm	38mm	105mm	With Antisplash Tube	3 Micron	0.75 Bar / 10.8 PSI	£46.76	€ 52.83
FT8F10BS0820	83mm	130mm	50mm	80mm	Flange & Basket	10 Micron	0.75 Bar / 10.8 PSI	£23.46	€ 26.51



ORDER CODE	OUTER DIAMETER	TOTAL LENGTH	WIDTH OF BASKET	LENGTH OF BASKET	MOUNTING	AIR RATING INNER ELEMENT	PRESSURISED RATING	NETT. PRICE	
PRESSURISED FILLER BREATHERS CONT.								£ STERLING	€ EUROS
FT8F10BS1520	83mm	200mm	50mm	150mm	Flange & Basket	10 Micron	0.75 Bar / 10.8 PSI	£24.27	€ 27.42
FT8F10BS1020	83mm	155mm	38mm	105mm	Flange & Removable Basket	10 Micron	0.75 Bar / 10.8 PSI	£23.39	€ 26.44
FT8F10BW1020	83mm	155mm	38mm	105mm	Welding Flange	10 Micron	0.75 Bar / 10.8 PSI	£23.78	€ 26.87
FT8F10BT1320	60mm	155mm	38mm	105mm	With Antisplash Tube	10 Micron	0.75 Bar / 10.8 PSI	£45.80	€ 51.76
PRESSURISED LOCKABLE FILLER BREATHERS								£ STERLING	€ EUROS
FT8F03BS081L	83mm	130mm	50mm	80mm	Flange & Basket	3 Micron	0.35 Bar / 5 PSI	£30.03	€ 33.93
FT8F03BS151L	83mm	200mm	50mm	150mm	Flange & Basket	3 Micron	0.35 Bar / 5 PSI	£30.63	€ 34.61
FT8F03BS101L	83mm	155mm	38mm	105mm	Flange & Removable Basket	3 Micron	0.35 Bar / 5 PSI	£28.95	€ 32.71
FT8F03BW101L	83mm	155mm	38mm	105mm	Welding Flange	3 Micron	0.35 Bar / 5 PSI	£29.90	€ 33.79
FT8F10BS081L	83mm	130mm	50mm	80mm	Flange & Basket	10 Micron	0.35 Bar / 5 PSI	£29.23	€ 33.03
FT8F10BS151L	83mm	200mm	50mm	150mm	Flange & Basket	10 Micron	0.35 Bar / 5 PSI	£30.03	€ 33.93
FT8F10BS101L	83mm	155mm	38mm	105mm	Flange & Removable Basket	10 Micron	0.35 Bar / 5 PSI	£29.16	€ 32.95
FT8F10BW101L	83mm	155mm	38mm	105mm	Welding Flange	10 Micron	0.35 Bar / 5 PSI	£29.55	€ 33.39
FT8F03BS082L	83mm	130mm	50mm	80mm	Flange & Basket	3 Micron	0.75 Bar / 10.8 PSI	£30.03	€ 33.93
FT8F03BS152L	83mm	200mm	50mm	150mm	Flange & Basket	3 Micron	0.75 Bar / 10.8 PSI	£30.63	€ 34.61
FT8F03BS102L	83mm	155mm	38mm	105mm	Flange & Removable Basket	3 Micron	0.75 Bar / 10.8 PSI	£28.95	€ 32.71
FT8F03BW102L	83mm	155mm	38mm	105mm	Welding Flange	3 Micron	0.75 Bar / 10.8 PSI	£29.90	€ 33.79
FT8F10BS082L	83mm	130mm	50mm	80mm	Flange & Basket	10 Micron	0.75 Bar / 10.8 PSI	£29.23	€ 33.03
FT8F10BS152L	83mm	200mm	50mm	150mm	Flange & Basket	10 Micron	0.75 Bar / 10.8 PSI	£30.03	€ 33.93
FT8F10BS102L	83mm	155mm	38mm	105mm	Flange & Removable Basket	10 Micron	0.75 Bar / 10.8 PSI	£29.16	€ 32.95
FT8F10BW102L	83mm	155mm	38mm	105mm	Welding Flange	10 Micron	0.75 Bar / 10.8 PSI	£29.55	€ 33.39



ORDER CODE	CAP WIDTH	TOTAL LENGTH	CONNECTION	AIR RATING INNER ELEMENT	PRESSURISED RATING	NETT. PRICE	
THREADED FILLER BREATHERS (CAP ONLY)						£ STERLING	€ EUROS
FT6F03B10	48mm	58mm	1/4" BSP	3 Micron	No Pressure Valve	£8.21	€ 9.28
FT6F03B20	48mm	58mm	3/8" BSP	3 Micron	No Pressure Valve	£8.21	€ 9.28
FT6F10B10	48mm	58mm	1/4" BSP	10 Micron	No Pressure Valve	£8.21	€ 9.28
FT6F10B20	48mm	58mm	3/8" BSP	10 Micron	No Pressure Valve	£8.21	€ 9.28
FT7F03B30	75mm	62.5mm	1/2" BSP	3 Micron	No Pressure Valve	£8.01	€ 9.05
FT7F03B40	75mm	62.5mm	3/4" BSP	3 Micron	No Pressure Valve	£8.01	€ 9.05
FT7F10B30	75mm	62.5mm	1/2" BSP	10 Micron	No Pressure Valve	£8.01	€ 9.05
FT7F10B40	75mm	62.5mm	3/4" BSP	10 Micron	No Pressure Valve	£8.01	€ 9.05
PRESSURISED THREADED FILLER BREATHERS (CAP ONLY)						£ STERLING	€ EUROS
FT7F03B31	75mm	62.5mm	1/2" BSP	3 Micron	0.35 Bar / 5 PSI	£18.40	€ 20.79
FT7F03B41	75mm	62.5mm	3/4" BSP	3 Micron	0.35 Bar / 5 PSI	£18.40	€ 20.79
FT7F10B31	75mm	62.5mm	1/2" BSP	10 Micron	0.35 Bar / 5 PSI	£18.40	€ 20.79
FT7F10B41	75mm	62.5mm	3/4" BSP	10 Micron	0.35 Bar / 5 PSI	£18.40	€ 20.79
FT7F03B32	75mm	62.5mm	1/2" BSP	3 Micron	0.75 Bar / 10.8 PSI	£18.40	€ 20.79
FT7F03B42	75mm	62.5mm	3/4" BSP	3 Micron	0.75 Bar / 10.8 PSI	£18.40	€ 20.79
FT7F10B32	75mm	62.5mm	1/2" BSP	10 Micron	0.75 Bar / 10.8 PSI	£18.40	€ 20.79
FT7F10B42	75mm	62.5mm	3/4" BSP	10 Micron	0.75 Bar / 10.8 PSI	£18.40	€ 20.79

SIGHT GLASSES, PLUGS AND BREATHERS

OIL LEVEL SIGHT GLASSES (METAL)

FK

www.flowfitonline.com
TECH. DATA SHEET
FA06



- Aluminium threaded with glass face
- Max temp. 150°C
- Max pressure 3 Bar
- Knob type • Nitrile seals

ORDER NO.	THREAD BSP	WIDTH MM	NETT. PRICE	
			£ STERLING	€ EUROS
FK14	1/4"	19	£2.70	€ 3.05
FK38	3/8"	22.5	£3.34	€ 3.77
FK12	1/2"	27	£4.78	€ 5.40
FK34	3/4"	32	£7.20	€ 8.14
FK10	1"	38	£7.68	€ 8.67
FK114	1 1/4"	48	£14.72	€ 16.63
FK112R	1 1/2"	55	£7.99	€ 9.03
FK20R	2"	76	£88.04	€ 99.49

OIL LEVEL SIGHT GLASS (PLASTIC)

SLNS - THREADED OIL LEVEL INDICATORS

www.flowfitonline.com
TECH. DATA SHEET
FA06

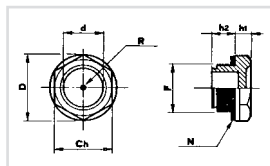

- Threaded Oil Level indicator, hex head with shoulder. Utilised in oiltanks, gearboxes and general machinery.
- This threaded level indicator allows a pressure of 3 bar.
- Asbestos free flat gasket. (available in NBR 70 shore on request)
- Manufactured from high density Polymide resin, which offers high mechanical resistance and withstands oil, gasoline, fuel and most solvents.

ORDER NO.	CH	F	D	D	H1	H2	NM	NETT. PRICE	
								£ STERLING	€ EUROS
SLNS14	17	1/4" BSP	20	15	7	8	6	£1.82	€ 2.05
SLN38	18	3/8" BSP	22	14	6.5	10.5	8	£2.17	€ 2.46
SLNS12	24	1/2" BSP	28	16	8	11	12	£2.13	€ 2.41
SLNS34	30	3/4" BSP	35	21	8	12	16	£2.91	€ 3.29
SLNS1	35	1" BSP	43	32	11	12	24	£4.03	€ 4.56
SLNS114	42	1 1/4" BSP	51	33	10	16		£8.30	€ 9.37
SLNS112	50	1 1/2" BSP	58	40	10	20		£10.43	€ 11.78
SLNS2	64	2" BSP	74	48	12	20		£7.41	€ 8.38

SLNT - THREADED OIL LEVEL INDICATORS WITH CONTRAST SCREEN FOR CLEARER INDICATION OF THE OIL LEVEL

www.flowfitonline.com
TECH. DATA SHEET
FA06

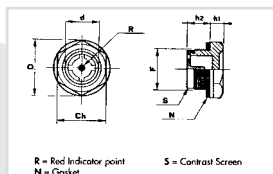

ORDER NO.	CH	F	D	D	H1	H2	NM	NETT. PRICE	
								£ STERLING	€ EUROS
SLNT38	18	3/8" BSP	22	14	6.5	10.5	8	£2.51	€ 2.84
SLNT12	24	1/2" BSP	28	16	8	11	12	£2.11	€ 2.38
SLNT34	30	3/4" BSP	35	21	8	12	16	£3.84	€ 4.34
SLNT1	35	1" BSP	43	32	11	12	24	£5.26	€ 5.94
SLNT114	42	1 1/4" BSP	51	33	10	16		£4.43	€ 5.01
SLNT112	50	1 1/2" BSP	58	40	10	20		£5.42	€ 6.12
SLNT2	64	2" BSP	74	48	12	20		£7.30	€ 8.25

LSB - OIL LEVEL INDICATOR IN TRANSPARENT THERMO PLASTIC SCREEN FOR CLEARER INDICATION OF THE OIL LEVEL

www.flowfitonline.com
TECH. DATA SHEET
FA06

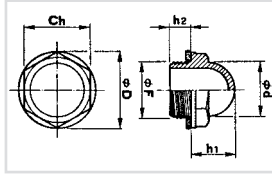

- Dome shaped Level Indicator, transparent, with incorporated hex, which enables to read Oil level an angle.
- Material is transparent Polyimide resin, which resists most chemicals, oil, gasoline, fuel and a variety of solvents.
- Maximum operating temperature: 100°C.
- Flat asbestos free, oil resistant seal.
- Nm = Applicable maximum tightening torque.

ORDER NO.	THREAD BSP.	CH	D	D	H1	H2	NM	NETT. PRICE	
								£ STERLING	€ EUROS
LSB38	3/8"	19	22	15	16	10	8	£2.40	€ 2.72
LSB12	1/2"	24	28	20	17	10	12	£2.71	€ 3.06
LSB34	3/4"	30	35	25	20	10	16	£3.71	€ 4.19
LSB1	1"	36	42	31	24	10.5	18	£5.06	€ 5.72

CF2 CF - DOME SHAPED THREADED OIL LEVEL INDICATOR GF - STEEL MOUNTING FLANGE

www.flowfitonline.com
TECH. DATA SHEET
FA06

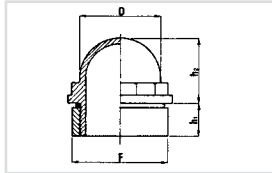

- Transparent halfball shaped level indicator, available with 2" and 3" threaded weld-on steel flanges.
- Made from Thermo Polycarbonate for optimal shock resistance and ensuring unbreakability.
- Product is utilised on truck/tankers and larger reservoirs containing liquids.

ORDER NO.	THREAD BSP	D	H1	H2	NETT. PRICE	
					£ STERLING	€ EUROS
CF2	2"	59	22	32	£5.47	€ 6.18
CF3	3"	85	32	63	£14.60	€ 16.49
GF2	2"	70	20		£19.59	€ 22.14
GF3	3"	102	30		£24.64	€ 27.85

TCNB LOW PROFILE PLUGS

www.flowfitonline.com
TECH. DATA SHEET
FA06

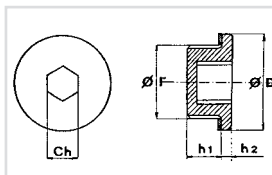

- Socket style low profile threaded plug.
- This low profile plug is made from reinforced Thermoplastic and provides an excellent mechanical resistance at both low and higher temperatures. (Max. 110°C.)
- Flat asbestos free seal
- For tightening torques (Nm) see table below.
- Special plugs in Polyimide IXEF 1022 are available for increased mechanical torque and temperatures up to 150°C. (see table Nm (IXEF)).

TYPE	F	CH	D	H1	H2	NM	NM(IXEF)	PRICE	
								£ STERLING	€ EUROS
TCNB14	1/4" BSP	6	20	8	2.5	3	5	£1.37	€ 1.54
TCNB38	3/8" BSP	8	22.5	10.5	3.5	6	6	£1.51	€ 1.71
TCNB12	1/2" BSP	10	28.5	10.5	3.5	8	10	£1.82	€ 2.05
TCNB34	3/4" BSP	12	35	10.5	4	10	18	£1.20	€ 1.35

TCN - OIL FILL PLUGS TCNS - OIL FILL PLUG WITH BREATHER HOLE TSN - OIL DRAIN PLUG

www.flowfitonline.com
TECH. DATA SHEET
FA06

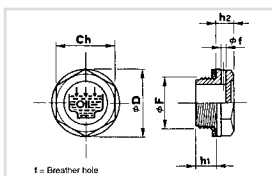

- Hex threaded oil fill plug in Thermoplastic material ensuring high mechanical resistance at both low and higher temperature (max. 100/110°C), dimensional stability and shock resistant.
- Flat asbestos free oil resistant seal.
- Style TCN and TCNS have the UNI fill symbol and the word OIL molded on top; the model TCNS has a breather hole located in the side of the hex with a diameter of 2-2.5mm.
- Style TSN has the UNI drain symbol on top.

TYPE	F	CH	D	H1	H2	NM	NETT. PRICE	
							£ STERLING	€ EUROS
TCN								
TCN14	1/4" BSP	17	19.5	9	7	5	£1.34	€ 1.52
TCN38	3/8" BSP	18	22	10	7.5	8	£1.51	€ 1.71
TCN12	1/2" BSP	24	28	11	7.5	9	£1.82	€ 2.05
TCN34	3/4" BSP	30	34	11	9	11	£2.48	€ 2.80
TCN1	1" BSP	35	42	12	10.5	20	£3.43	€ 3.88
TCN114	1 1/4" BSP	42	51	13.5	12		£5.11	€ 5.78
TCN112	1 1/2" BSP	50	58	16	10		£5.78	€ 6.53
TCN2	2" BSP	64	74	16	12		£9.57	€ 10.81
TCNS								
TCNS14	1/4" BSP	17	19.5	9	7	5	£1.17	€ 1.32
TCNS38	3/8" BSP	18	22	10	7.5	8	£1.29	€ 1.46
TCNS12	1/2" BSP	24	28	11	7.5	9	£1.94	€ 2.20
TCNS34	3/4" BSP	30	34	11	9	11	£1.95	€ 2.21
TCNS1	1" BSP	35	42	12	10.5	20	£2.88	€ 3.25
TCNS114	1 1/4" BSP	42	51	13.5	12		£4.21	€ 4.76
TCNS112	1 1/2" BSP	50	58	16	10		£5.46	€ 6.17
TCNS2	2" BSP	64	74	16	12		£7.85	€ 8.88
TSN								
TSN14	1/4" BSP	17	19.5	9	7	5	£1.20	€ 1.35
TSN38	3/8" BSP	18	22	10	7.5	8	£1.35	€ 1.53
TSN12	1/2" BSP	24	28	11	7.5	9	£1.63	€ 1.84
TSN34	3/4" BSP	30	34	11	9	11	£2.23	€ 2.52
TSN1	1" BSP	35	42	12	10.5	20	£3.08	€ 3.48
TSN114	1 1/4" BSP	42	51	13.5	12		£3.08	€ 3.48
TSN112	1 1/2" BSP	50	58	16	10		£4.59	€ 5.19
TSN2	2" BSP	64	74	16	12		£5.20	€ 5.87

TMA ALUMINIUM DRAIN PLUG WITH MAGNET

www.flowfitonline.com
TECH. DATA SHEET
FA06

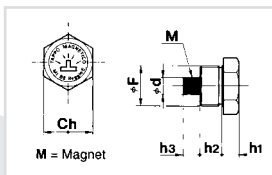

- Hex plug manufactured from aluminium 11s complete with asbestos free flat seal
- Fitted with pressed-in cylindrical magnet
- Fitted to base of tanks to remove ferrous particles
- Text — magnetic

TYPE	F	CH	D	H1	H2	PRICE	
						£ STERLING	€ EUROS
TMA14	1/4" BSP	18	8	7	10	£5.66	€ 6.40
TMA38	3/8" BSP	22	10	7	10	£8.19	€ 9.25
TMA12	1/2" BSP	27	10	8	10	£8.61	€ 9.73
TMA34	3/4" BSP	34	13	8	10	£14.41	€ 16.28
TMA1	1" BSP	40	13	8	14	£19.55	€ 22.09

TCZS - KNURLED OIL FILL PLUG WITH BREATHER HOLE

www.flowfitonline.com
TECH. DATA SHEET
FA06

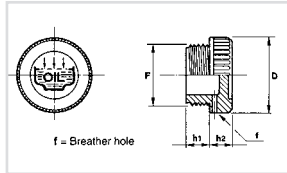

- Threaded plug with knurled head in Thermoplastic material (Polymide 66) ensuring high mechanical resistance at both low and high temperature (max. 100/110°C). Excellent dimensional stability and shock resistant.
- 'O' ring seal or 70 shore rubber seal.
- Available in standard black colour, red on request.
- Style TCZS has molded UNI fill symbol and the text "OIL" molded on top
- Style TSZ has the UNI drain symbol molded on top.
- The style TZCS incorporates a breather hole, located on the knurled rim with a diameter of 2-3mm.

TYPE	F	D	H1	H2	NETT. PRICE	
					£ STERLING	€ EUROS
TCZS						
TCZS14	1/4" BSP	20	9	9	£1.94	€ 2.20
TCZS38	3/8" BSP	20.5	10	9	£1.66	€ 1.87
TCZS12	1/2" BSP	28	10.5	10.5	£1.37	€ 1.54
TCZS34	3/4" BSP	31	11	12	£2.70	€ 3.05
TCZS1	1" BSP	39	12	12	£3.56	€ 4.02
TCZS114	1 1/4" BSP	49	13.5	13	£5.29	€ 5.98
TCZS112	1 1/2" BSP	55	14.5	14.7	£6.66	€ 7.52
TCZS2	2" BSP	68.5	16	15	£9.79	€ 11.06

TCSA - OIL FILL PLUG WITH BREATHER AND VANE TCSF - OIL FILL PLUG WITH BREATHER, VANE AND FILTER

www.flowfitonline.com
TECH. DATA SHEET
FA06

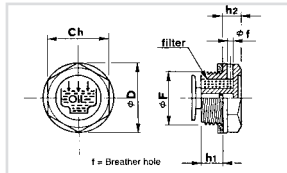

- Hex head oil fill plug made from Thermoplastic material (Polymide 66), ensuring high mechanical resistance at both low and higher temperatures. (max. 100/110°C).
- This product offers excellent dimensional stability and is shock resistant.
- Asbestos free flat oil resistant seal.
- The plugs are marked with the UNI fill symbol and the word OIL, the breather hole is located on the side of the hex, with a diameter of 2-3mm.
- The incorporated oil dampening vane will reduce spillage when strong oil movement in the container or reservoir takes place.
- The Polyurethane foam filter prevents contamination from the ambient atmosphere polluting the oil.

TYPE	F	CH	D	H1	H2	NM	NETT. PRICE	
							£ STERLING	€ EUROS
TCSA								
TCSA14	1/4" BSP	17	19.5	9	7	5	£1.51	€ 1.71
TCSA38	3/8" BSP	18	22	10	7.5	8	£1.75	€ 1.98
TCSA12	1/2" BSP	24	28	11	7.5	9	£1.37	€ 1.54
TCSA34	3/4" BSP	30	34	11	9	11	£2.57	€ 2.91
TCSA1	1" BSP	35	42	12	10.5	20	£3.45	€ 3.90
TCSA114	1 1/4" BSP	42	51	13.5	12		£4.67	€ 5.28
TCSF								
TCSF38	3/8" BSP	18	22	10	7.5	8	£2.80	€ 3.17
TCSF12	1/2" BSP	24	28	11	7.5	9	£3.00	€ 3.39
TCSF34	3/4" BSP	30	34	11	9	11	£4.16	€ 4.70
TCSF1	1" BSP	35	42	12	10.5	20	£5.11	€ 5.78
TCSF114	1 1/4" BSP	42	51	13.5	12		£4.67	€ 5.28

TM DRAIN PLUG WITH MAGNET

www.flowfitonline.com
TECH. DATA SHEET
FA06

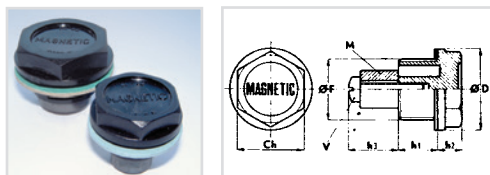

- Thermoplastic hex plug with magnet.
- The plug is mounted on the bottom of the transmission or tank, to be used as drain plug. The magnetic disk will attract ferrous metal parts and contains them, preventing damage to gears and other moving components.
- This plug is manufactured in the colour black, with a hot painted description MAGNETIC in a bright colour.
- Oil resistant asbestos free seal.
- In larger quantities, these plugs are available with other than the shown threads, ie: M16 18 20 22.

TYPE	F	CH	D	H1	H2	H3	NETT. PRICE	
							£ STERLING	€ EUROS
TM14	1/4"	17	20	9	7	5	£4.18	€ 4.72
TM38	3/8"	18	22	10	7.5	10	£5.39	€ 6.09
TM12	1/2"	24	27	11	8	9	£6.23	€ 7.04
TM34	3/4"	30	34	11	9	6.5	£8.36	€ 9.44
TM1	1"	35	42	12	10.5	14	£10.83	€ 12.23

KMF METAL FILLER PLUG WITH FILTER

www.flowfitonline.com
TECH. DATA SHEET
FA06

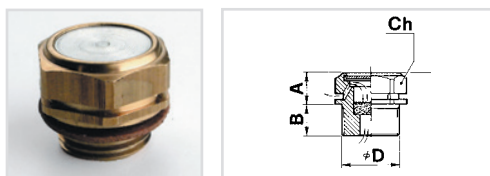

- SINTERED METAL FILTER 50/60 MICRON
- FIBRE ASBESTOS - FREE SEAL
- FOUR BREATHER HOLES ARE LOCATED UNDER THE HEX HEAD PROVIDING AN ADEQUATE BREATHING CAPACITY
- IDEAL FOR GEARBOXES AND TRANSMISSION APPLICATIONS

TYPE	ØD	CH	A	B	NETT. PRICE	
					£ STERLING	€ EUROS
KMF14	1/4"BSP	18	13	9	£6.58	€ 7.44
KMF38	3/8"BSP	22	14	10	£8.10	€ 9.15
KMF12	1/2"BSP	27	14	10	£8.94	€ 10.10

TCAS HEX PLUG WITH DIPSTICK AND BREATHER HOLE

www.flowfitonline.com
TECH. DATA SHEET
FA06

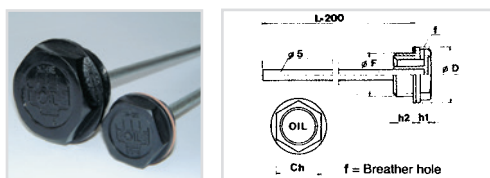

- Hex threaded plug with dipstick (diam. 4.5mm steel), material plug: (Polymide 66) maximum temperature 100/110°C.
- Oil resistant seal. ('O' ring, 70 shore)
- The model TCAS has a breather hole located in the side of the knurled head, with a diameter of 2-2.5mm.
- The standard dipstick is delivered in a 200mm length, on larger quantities they can be manufactured to the customers specific length, and MIN-MAX notches can be placed in the desired position.

TYPE	F	CH	D	H1	H2	NETT. PRICE	
						£ STERLING	€ EUROS
TCAS14	1/4" BSP	17	19	7	9	£2.56	€ 2.90
TCAS38	3/8" BSP	18	22	7.5	10	£2.72	€ 3.07
TCAS12	1/2" BSP	24	28	7.5	11	£2.89	€ 3.26
TCAS34	3/4" BSP	30	34	9	11	£3.56	€ 4.02
TCAS1	1" BSP	35	42	10.5	12	£4.28	€ 4.84
TCAS114	1 1/4" BSP	42	51	12	13.5	£5.64	€ 6.37
TCAS2	2" BSP	64	74	13.5	16	£9.08	€ 10.26

TMD - FILLER BREATHER WITH DOUBLE BREATHER HOLE
TMDF - FILLER BREATHER WITH DOUBLE BREATHER HOLE AND FILTER

www.flowfitonline.com
 TECH. DATA SHEET
FA06

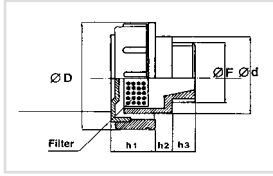

- Round headed Filler Breather, with vertical ribs for better grip. Oil resistant seal. ('O' ring, 70 shore)
- The Filler Breather is produced from Polyimide 66, ensuring high mechanical resistance at both low and higher temperatures. (maximum temperature 100/110°C)
- This product offers excellent dimensional stability and is shock resistant.
- These Filler Breathers allow air passage at high volume, through the vents located on the bottom of the head. They are recommended to be used in systems where a large amount of oil level changes take place in a short amount of time, allowing the air to enter and leave the system without any unwanted air pressure increase or decrease.
- Style TMDF has a standard Polyurethane foam filter (60 Micron) built in. This filter is located under the red lid, easy to remove, clean and reinstall.

TYPE	F	D	D	H1	H2	H3	NETT. PRICE	
							£ STERLING	€ EUROS
TMD								
TMD38	3/8"	36	23	17	5	11	£3.74	€ 4.22
TMD12	1/2"	41	28	18	5	12	£4.22	€ 4.77
TMD34	3/4"	47	33	17	5	12	£4.97	€ 5.61
TMD1	1"	52	38	20	5	12	£6.11	€ 6.91
TMD114	1 1/4"	63	49	23	5	13	£7.92	€ 8.95
TMD112	1 1/2"	63	55	23	5	13.5	£8.36	€ 9.44
TMDF								
TMDF38	3/8" BSP	36	23	17	5	11	£5.52	€ 6.24
TMDF12	1/2" BSP	41	28	18	5	12	£6.27	€ 7.08
TMDF34	3/4" BSP	47	33	17	5	12	£7.00	€ 7.91
TMDF1	1" BSP	52	38	20	5	12	£8.65	€ 9.78
TMDF114	1 1/4" BSP	63	49	23	5	13	£10.93	€ 12.35
TMDF112	1 1/2" BSP	63	55	23	5	13.5	£11.52	€ 13.02

TMDA
FILLER BREATHER WITH LARGE BREATHER HOLE AND DIPSTICK
TMDFA
FILLER BREATHER WITH LARGE BREATHER HOLE, DIPSTICK AND FILTER

www.flowfitonline.com
 TECH. DATA SHEET
FA06

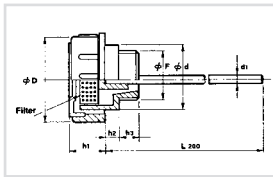

- The below Filler Breathers have the same characteristics as the models TMD - TMDF, but are equipped with a dipstick.
- The standard dipstick is 200mm in length.

TYPE	F	D	D	H1	H2	H3	NETT. PRICE	
							£ STERLING	€ EUROS
TMDA								
TMDA38	3/8" BSP	36	23	17	5	11	£5.24	€ 5.92
TMDA12	1/2" BSP	41	28	18	5	12	£5.74	€ 6.49
TMDA34	3/4" BSP	47	33	17	5	12	£7.14	€ 8.07
TMDA1	1" BSP	52	38	20	5	12	£7.71	€ 8.71
TMDA114	1 1/4" BSP	63	49	23	5	13	£10.02	€ 11.32
TMDA112	1 1/2" BSP	63	55	23	5	13.5	£10.09	€ 11.40
TMDFA								
TMDFA38	3/8" BSP	36	23	17	5	11	£7.44	€ 8.41
TMDFA12	1/2" BSP	41	28	18	5	12	£8.19	€ 9.25
TMDFA34	3/4" BSP	47	33	17	5	12	£9.57	€ 10.81
TMDFA1	1" BSP	52	38	20	5	12	£10.02	€ 11.32
TMDFA114	1 1/4" BSP	63	49	23	5	13	£12.81	€ 14.48
TMDFA112	1 1/2" BSP	63	55	23	5	13.5	£13.81	€ 15.60

TSF NEW VENT PLUG TO REDUCE OIL OIL DAMP ESCAPE

www.flowfitonline.com
TECH. DATA SHEET
FA06

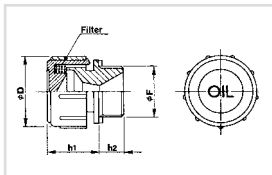

- Filler Breather with easy grip vertical ribs, manufactured from Thermoplastic material (Polymide 66). Maximum working temperature 100° C.
- These style Filler Breathers are produced in black with a red lid, with the text "OIL". On large orders a custom text or company logo is possible.
- A standard flat rubber seal is used , but a 'O' ring seal is available, both in NBR 70 shore.
- Located under the lid is a Polyurethane foam filter (50 Micron) installed, which is easy to be cleaned once the lid is removed.
- The series TSF has a specially designed cavity which prevents oil from escaping through the Breather holes when it is splashed in an upward direction, often occurring when there is a strong oil movement due to rotating gears.
- The inside of the TSF features a conical cavity which, due to its design entraps oil but allows air to escape and enter (within limitations).
- These Filler Breather plugs are utilised on hydraulic power packs, oil tanks, gear reduction boxes, gearboxes or any application where strong movement causes splashing oil in or around the Filler Breather.

TYPE	F	D	H1	H2	NETT. PRICE	
					£ STERLING	€ EUROS
TSF14	1/4" BSP	30	21	10	£3.66	€ 4.14
TSF38	3/8" BSP*	30	21	10	£3.99	€ 4.51
TSF12	1/2" BSP*	30	21	10	£4.28	€ 4.84

*On request available in NPT

TPF - PRESS-FIT FILLER BREATHER WITH LARGE BREATHER HOLE AND FILTER

www.flowfitonline.com
TECH. DATA SHEET
FA06

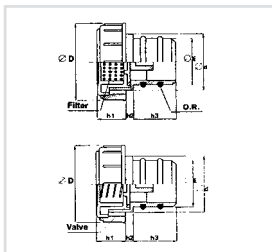

- Press-fit Filler Breather with easy grip vertical ribs.
- These Filler Breathers are not threaded, but fit snugly into a pre-drilled hole and seal by means of 'O' rings located on the stem. Hole tolerances: -0 + 0.1mm.
- These Filler Breathers are produced from Thermoplastic Polymide 66 which offers high mechanical resistance at both lower and higher temperatures (100°C max).
- Seals: 2 Oil resistant 'O' Rings, NBR 70 shore.
- The Filler Breather model TP/F has a large breathing capacity and is applied where a high volume of air change takes place, in example, hydraulic systems that utilise high ratio hydraulic cylinders. They are not recommended for usage on mobile equipment, where strong movement of the oil tank is present.

TYPE	F	D	D	H1	H2	H3	NETT. PRICE	
							£ STERLING	€ EUROS
TPF								
TPF18	18	36	23	17	5	10	£6.80	€ 7.69
TPF20	20	36	24	17	4	19	£7.51	€ 8.48
TPF26	26	41	28	17	4	21	£8.28	€ 9.36
TPF30	30	47	33	17	4	21	£9.95	€ 11.25

FLOWFIT®
24 HOUR DELIVERY

CONTACT OUR SALES AND TECHNICAL TEAM DIRECTLY WITH OUR NEW DIRECT DIALS

WHETHER YOU HAVE A QUERY, ISSUE OR SEEK TECHNICAL ADVICE AND
NEED TO SPEAK TO A MEMBER OF OUR TEAM?
YOU CAN NOW CONTACT US DIRECTLY USING THE NUMBERS BELOW



MIKE PARSONAGE
SALES DIRECTOR

SUPERVISES BUSINESS DEVELOPMENT
MANAGER AND VISITS CURRENT AND
POTENTIAL CUSTOMERS WITHIN THE UK

01584 838490
07855401947



DARRON TOLLEY
GENERAL MANAGER

OVERSEES THE GENERAL DAY TO DAY
RUNNING OF BUSINESS & TECHNICAL
SALES TEAM

01584 838482
07814494360



HARRY PARSONAGE
ASSISTANT GENERAL MANAGER

ASSISTS WITH CUSTOMER
ENQUIRIES & CUSTOMER CARE

01584 838488
07398521668



WAYNE ANGELL
TECHNICAL MANAGER

OFFERS CUSTOMERS DYNAMIC, EXPERT TECHNICAL
ADVICE. DESIGNS HYDRAULIC SYSTEMS
DEPENDING ON CUSTOMER REQUIREMENTS.

01584 838483
07765686171



ANDY MORRIS
SPECIAL PROJECT MANAGER

RESPONSIBLE FOR THE PLANNING AND
IMPLEMENTATION OF THE TECHNICAL
DEPARTMENTS SPECIAL PROJECTS.

01584 838485
07553592317



JESS JAMES
SALES OFFICE MANAGER

OVERSEE'S SALES TEAM, ASSISTS WITH
CUSTOMER ENQUIRIES & CUSTOMER
CARE, CUSTOMER VISITS

01584 838484



JAKE PARSONAGE
BUSINESS DEVELOPMENT MANAGER

FOLLOWS UP ON ORDERS,
VISITS CURRENT AND POTENTIAL
CUSTOMERS WITHIN THE UK

01584 838494
07950963176



ADAM LITTLETON
ASSISTANT TECHNICAL MANAGER

OFFERS CUSTOMERS DYNAMIC, EXPERT
TECHNICAL ADVICE, ASSISTS WITH
DESIGNING HYDRAULIC SYSTEMS

01584 838486



WILLIAM WOOD
OPERATIONS MANAGER

ASSISTS WITH CUSTOMER ENQUIRIES,
CUSTOMER CARE & PRODUCT SOURCING

01584 838487

ORDERING FROM US IS EASY...



CALL

01584 876033

MON-THURS 8:30AM-5:00PM

FRI 8:00AM-4:00PM



CLICK

www.flowfitonline.com

24 HOURS A DAY

7 DAYS A WEEK



VISIT

Shop open 5 Days a week

MON-THURS 8:30AM-5:00PM

FRI 8:00AM-4:00PM



HOW TO FIND US

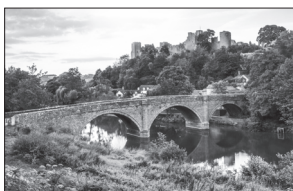

Flowfit is proud to be based in Ludlow, in beautiful South Shropshire.

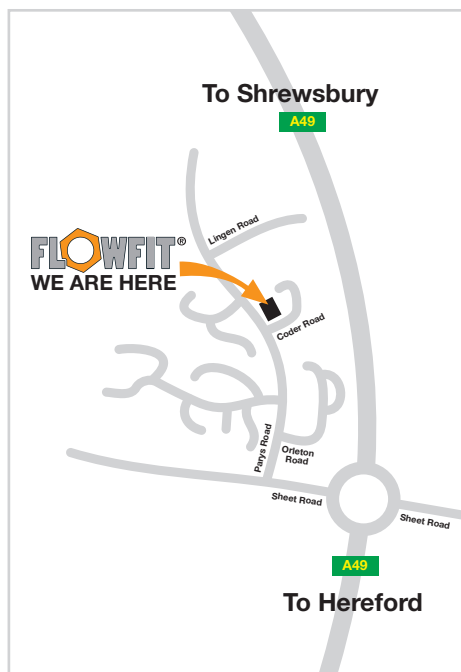

Harrier Fluid Power Ltd T/A Flowfit, Parys Road, Ludlow Business Park, Ludlow, Shropshire SY8 1XY

Telephone: +44 (0)1584 876 033 Fax: +44 (0)1584 876 044

Email: sales@flowfitonline.com

Every effort has been made to ensure that the information in this catalogue is correct. However, we reserve the right to introduce changes without prior notice. This catalogue supersedes all previous catalogues.



PROMOTING THE HIGHEST STANDARD IN FLUID POWER DISTRIBUTION