

24VDC 1.6KW 2500rpm	24VDC	2.1cc/r	7L	160 bar	G3/8"
Motor	Lowering Coil Voltage	Gear Pump	Oil Tank	System Pressure	

# FLOWFIT®



**MANUFACTURERS AND SUPPLIERS  
OF HYDRAULIC COMPONENTS**

PART NUMBER ZZ016020

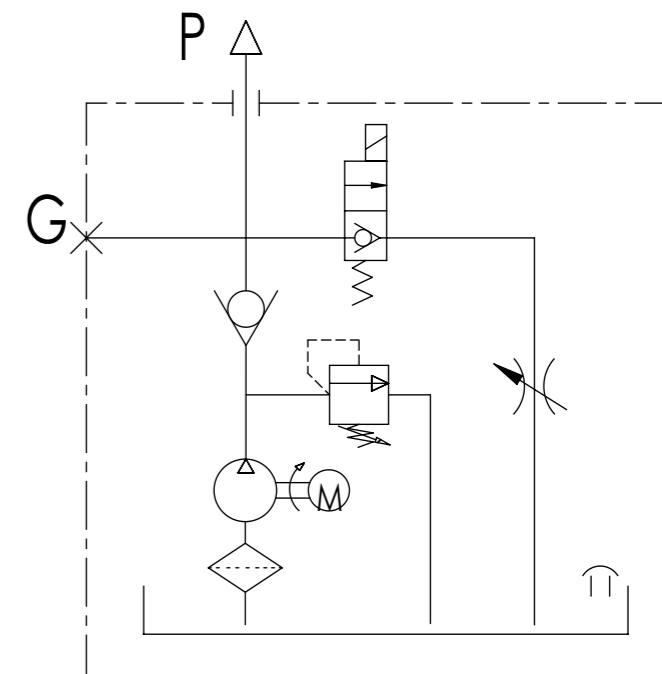
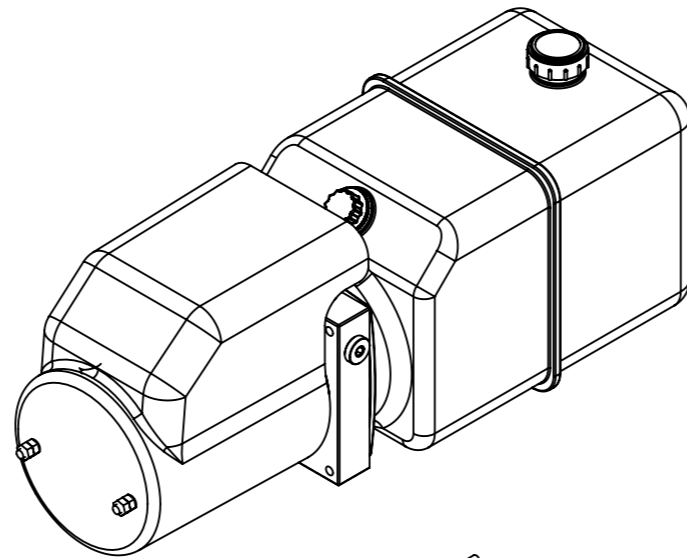
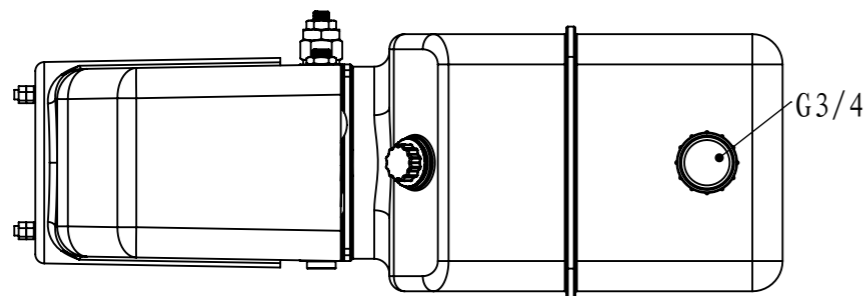
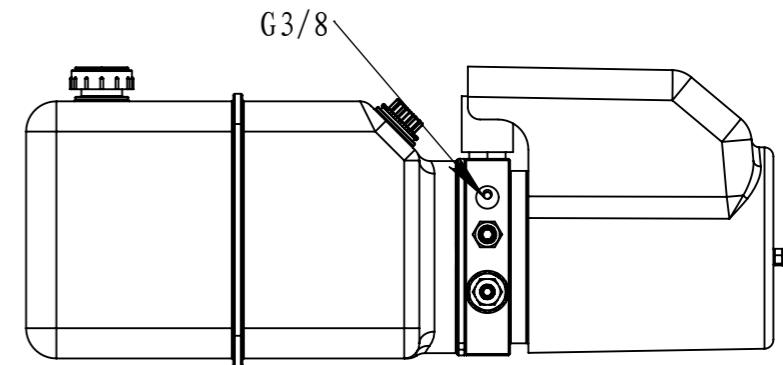
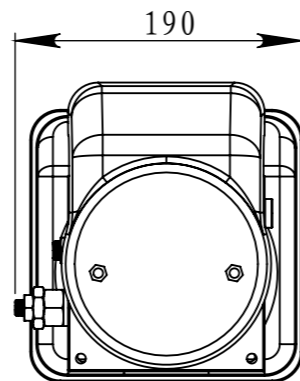
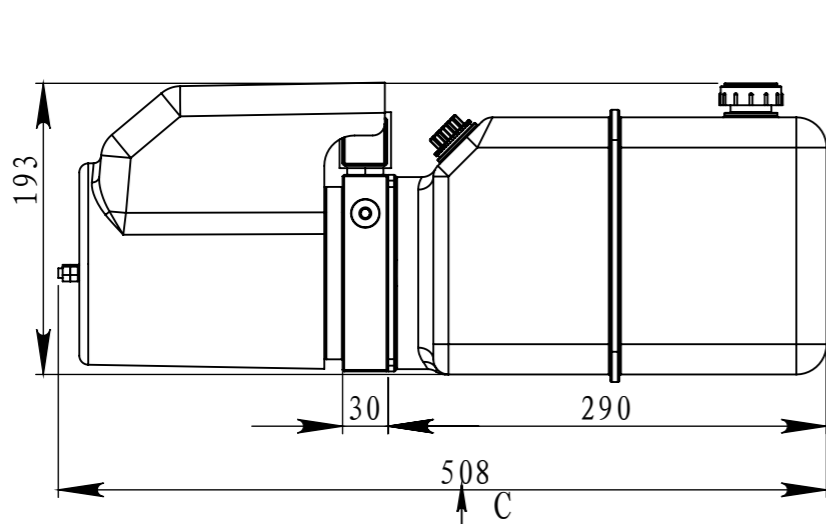

2 x  $\varnothing$  8.50  $\nabla$  17  
M10 - 6H  $\nabla$  15

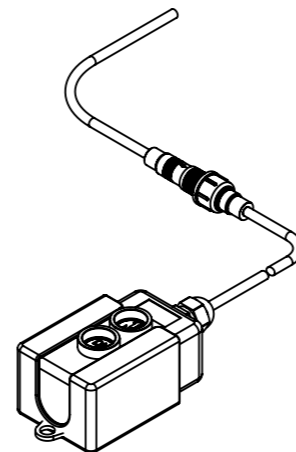
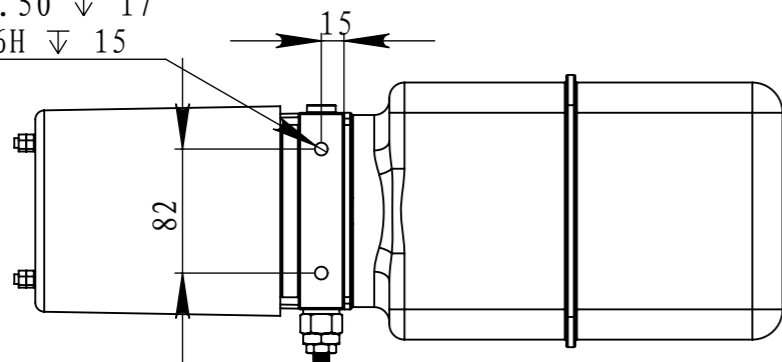

**Everything Hydraulic**