

Hydraulic Imperial Compression Fittings

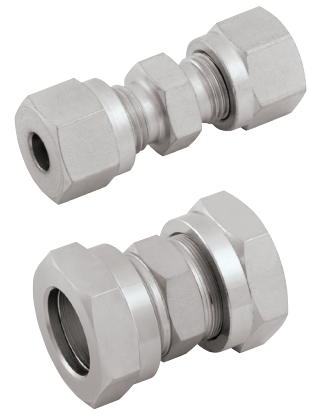
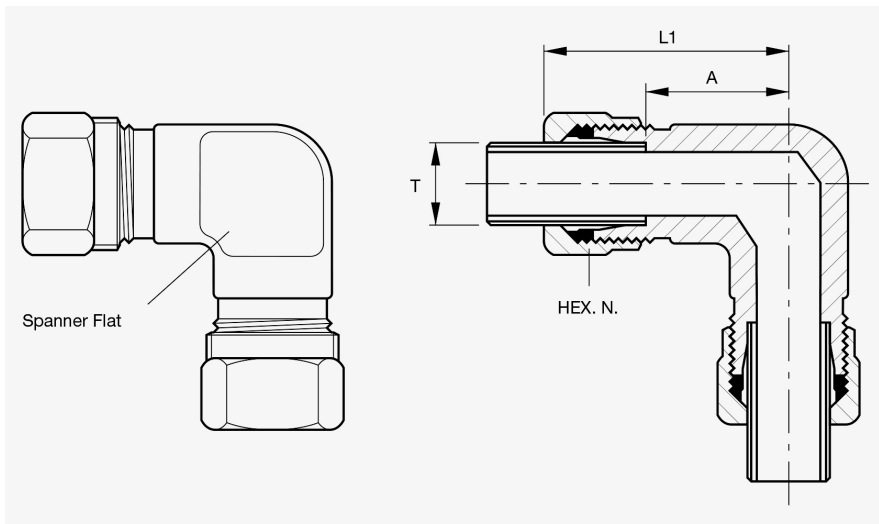

O.D. TUBES

Part No.	Tube Dia. T.	Nut Hexagon N.	A/F Spanner Flat	Tube Abutment A.	O/A Length L.
2018-8975	1/4"	.710"	.468"	2 1/32"	1 3/8"
2018-8991	5/16"	.710"	.600"	2 3/32"	1 1/16"
2019-9007	3/8"	.820"	.600"	1 3/16"	1 17/32"
2019-9015	1/2"	.920"	.710"	3 1/32"	1 29/32"
2018-9023	5/8"	1.10"	.820"	1 1/16"	1 27/32"
2018-9031	3/4"	1.20"	1.10"	1 9/16"	2 1/8"
2018-9049	7/8"	1.375"	1.10"	1 7/16"	2 5/16"
2018-9056	1"	1.67"	1.30"	1 19/32"	2 17/32"
2018-9064	1 1/4"	2.05"	1.56"	1 15/16"	2 29/32"
2018-9072	1 1/2"	2.22"	1.80"	1 15/16"	3 3/8"

N.B. TUBES

Part No.	N.B. Tube Size T.	Nut Hexagon N.	A/F Spanner Flat	Tube Abutment A.	O/A Length L.
2018-9080	1/4"	1.10"	.820"	1 1/16"	1 27/32"
2018-9098	3/8"	1.20"	1.062"	1 9/16"	2 1/8"
2018-9106	1/2"	1.375"	1.062"	1 1/16"	2 5/16"
2018-9114	3/4"	1.67"	1.312"	1 5/8"	2 5/8"
2018-9122	1"	2.05"	1.56"	1 15/16"	2 29/32"
2018-9130	1 1/4"	2.58"	2.31"	2 1/16"	3 17/32"

Technical Data:

- 1" O.D. 690 bar (10,000 psi) hydraulic or 345 bar (5,000 psi) gas.
 1.1/4" O.D. 552 bar (8,000 psi) hydraulic or 276 bar (4,000 psi) gas.

N.B. Couplings are suitable for the following pressures, up to and including:

- 3/4" N.B. 690 bar (10,000 psi) hydraulic or 345 bar (5,000 psi) gas.
 1" N.B. 552 bar (8,000 psi) hydraulic or 276 bar (4,000 psi) gas.
 1.1/2" N.B. 345 bar (5,000 psi) hydraulic or 173 bar (2,500 psi) gas.