

SERIES 30100 MECHANICAL CLUTCH GROUP1 AND GROUP2 • 30KW

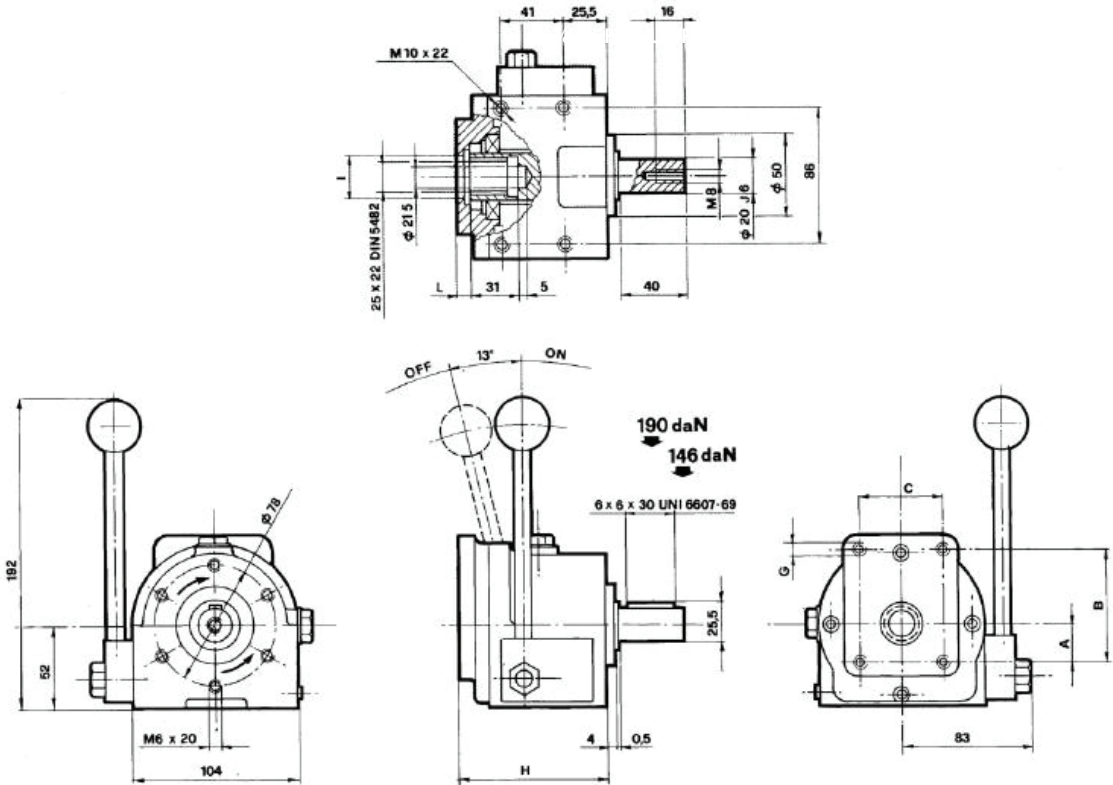

The mechanical couplings with two direction arrows are REVERSIBLE

Nominal torque	Max. speed	Max. power output	Axial load
9 daNm	2000 RPM	Kw 30	120 daN

DIRECTION OF ROTATION	PUMP GROUP	A	B	C	G	H	I	L
REVERSIBLE CLOCKWISE ANTICLOCKWISE	1	26.3	72	52.4	M6x12	92.5	25.4 H7	7
	2	32.5	96	71.4	M6x15	95.5	36,5 H7	10
REVERSIBLE CLOCKWISE	2 BOSCH	34.5	100	72	M8x15	95.5	80 H7	10

GEAR PUMP – PUMPS GROUP 2 PERFORMANCE

Flow - Speed chart

