

13 Displacements 13 Schluckvolumen 13 Cylindrée 13 Desplazamientos	(8.6 to 58.5 in ³ /rev) 140 . . . 959 cm ³ /rev
Maximum Pressure Eingangsdruck Pression entrée Presion Maxima	Cont. (3000 psid) ... 207 bar Int. (4000 psid) ... 276 bar
Maximum Oil Flow Schluckstrom Débit d'huile Caudal Maximo de Aceite	(30 gpm) ... 114 lpm
Maximum Speed Drehzahl Vitesse de rotation Velocidad Maxima	(660 rpm) 660 rpm
Maximum Torque MaxDrehmoment Couple Torque Maximo	Cont. (9,239 lb in) 1044 Nm Int. (12,636 lb in) 1428 Nm
Maximum Side Load at Key Seitenlast Charges latérales Carga Maxima Lateral	(3597 lb) ... 16000 N

CAUTION!
See installation/operating instructions for product cautions and proper use.

Exceptional Strength and Durability in a High Performance Motor/Brake Package

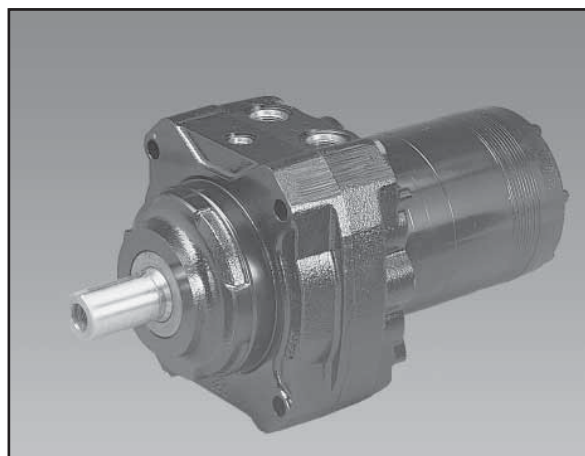







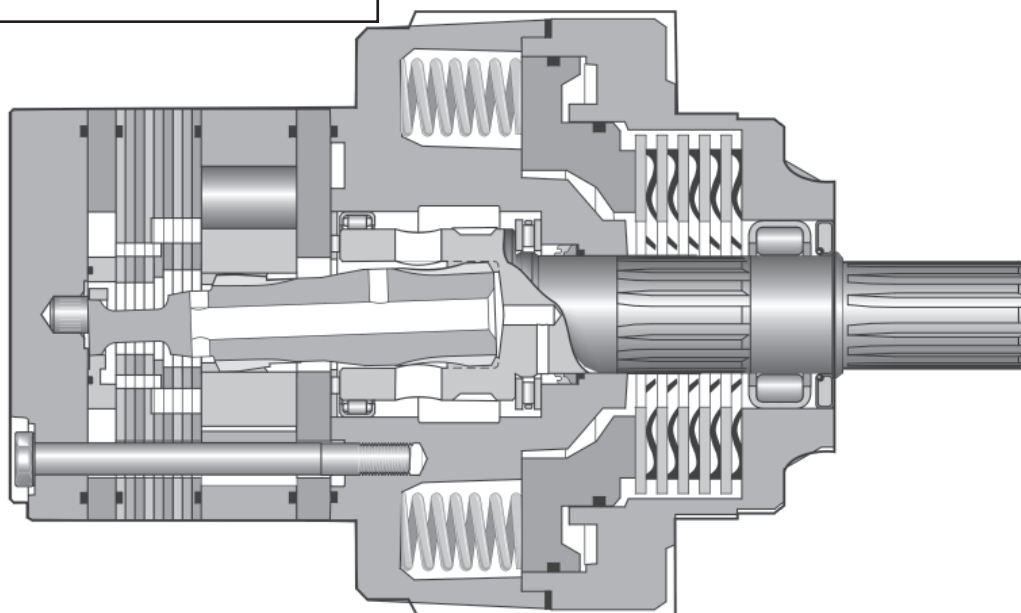







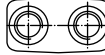
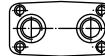
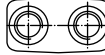
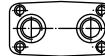















This brake motor consists of a BG Series motor integrated into a wet disc, spring applied, hydraulically released brake. Standard holding capacity is 12,000 lb in of holding torque. The brake is front mounted for reliable operation even in the event of a system failure. The brake release port is capable of pressures to 3000 PSI.

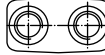
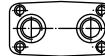

Rated Brake Holding Capacity @ Zero Release Pressure Nm (in-lbs)	Minimum Full Release Pressure bar (PSI)
1350 (12,000)	22 (315)

12,000 in-lbs is standard holding capacity.
For other holding capacities, see page 265.



BG	XXXX	X	X	XX	0	XXXX																																																																							
Series	Displacement Schluckvolumen Cylindrée Desplazamiento	Mounting Gehäuse Carter Montaje	Ports Anschluß Plan de raccordement Lumbreras	Shaft Welle Arbre Eje	Rotation Drehrichtung Direction de rotation Rotacion	Options Opciones																																																																							
<table border="1" style="width: 100%; border-collapse: collapse;"> <thead> <tr> <th style="width: 10%;">Code</th> <th style="width: 90%;">cm³/U cm³/tr cm³/giro in³/rev</th> </tr> </thead> <tbody> <tr><td>0140</td><td>141 / 8.6</td></tr> <tr><td>0170</td><td>169 / 10.3</td></tr> <tr><td>0195</td><td>195 / 11.9</td></tr> <tr><td>0240</td><td>238 / 14.5</td></tr> <tr><td>0280</td><td>280 / 17.1</td></tr> <tr><td>0310</td><td>310 / 18.9</td></tr> <tr><td>0335</td><td>337 / 20.6</td></tr> <tr><td>0405</td><td>405 / 24.7</td></tr> <tr><td>0475</td><td>477 / 29.1</td></tr> <tr><td>0530</td><td>528 / 32.3</td></tr> <tr><td>0625</td><td>623 / 38.0</td></tr> <tr><td>0785</td><td>786 / 48.0</td></tr> <tr><td>0960</td><td>959 / 58.5</td></tr> </tbody> </table>		Code	cm ³ /U cm ³ /tr cm ³ /giro in ³ /rev	0140	141 / 8.6	0170	169 / 10.3	0195	195 / 11.9	0240	238 / 14.5	0280	280 / 17.1	0310	310 / 18.9	0335	337 / 20.6	0405	405 / 24.7	0475	477 / 29.1	0530	528 / 32.3	0625	623 / 38.0	0785	786 / 48.0	0960	959 / 58.5	<table border="1" style="width: 100%; border-collapse: collapse;"> <thead> <tr> <th style="width: 10%;">Code</th> <th style="width: 90%;">Mounting</th> </tr> </thead> <tbody> <tr> <td style="text-align: center;">A</td> <td>Front Mtg/Front Bolting 1/2-13 UNC Thd </td> </tr> <tr> <td style="text-align: center;">B</td> <td>SAE "B" 2 Bolt </td> </tr> <tr> <td style="text-align: center;">C</td> <td>Rear Mtg/Thru Bolting </td> </tr> </tbody> </table>		Code	Mounting	A	Front Mtg/Front Bolting 1/2-13 UNC Thd 	B	SAE "B" 2 Bolt 	C	Rear Mtg/Thru Bolting 	<table border="1" style="width: 100%; border-collapse: collapse;"> <thead> <tr> <th style="width: 10%;">Code</th> <th style="width: 90%;">Ports</th> </tr> </thead> <tbody> <tr> <td style="text-align: center;">S</td> <td>7/8-14 SAE </td> </tr> <tr> <td style="text-align: center;">M</td> <td>Manifold </td> </tr> </tbody> </table>		Code	Ports	S	7/8-14 SAE 	M	Manifold 	<table border="1" style="width: 100%; border-collapse: collapse;"> <thead> <tr> <th style="width: 10%;">Code</th> <th style="width: 90%;">Shaft</th> </tr> </thead> <tbody> <tr> <td style="text-align: center;">03</td> <td>1 1/4" Keyed </td> </tr> <tr> <td style="text-align: center;">05</td> <td>1 1/4" 14 Tooth Spline </td> </tr> <tr> <td style="text-align: center;">08</td> <td>1 1/4" Tapered* </td> </tr> <tr> <td style="text-align: center;">19</td> <td>1 3/8" Tapered* </td> </tr> <tr> <td style="text-align: center;">62</td> <td>SAE 14 Tooth Spline </td> </tr> </tbody> </table>		Code	Shaft	03	1 1/4" Keyed 	05	1 1/4" 14 Tooth Spline 	08	1 1/4" Tapered* 	19	1 3/8" Tapered* 	62	SAE 14 Tooth Spline 	<table border="1" style="width: 100%; border-collapse: collapse;"> <thead> <tr> <th style="width: 10%;">Code</th> <th style="width: 90%;">Front Port Rotation</th> </tr> </thead> <tbody> <tr> <td style="text-align: center;">0</td> <td>Standard </td> </tr> <tr> <td style="text-align: center;">1</td> <td>Reverse Timed Manifold </td> </tr> </tbody> </table>		Code	Front Port Rotation	0	Standard 	1	Reverse Timed Manifold 	<table border="1" style="width: 100%; border-collapse: collapse;"> <thead> <tr> <th style="width: 10%;">Code</th> <th style="width: 90%;">Description</th> </tr> </thead> <tbody> <tr> <td style="text-align: center;">AAAB</td> <td>No Paint No lackiert</td> </tr> <tr> <td style="text-align: center;">AAAA</td> <td>Black Paint Schwarz lackiert</td> </tr> </tbody> </table>		Code	Description	AAAB	No Paint No lackiert	AAAA	Black Paint Schwarz lackiert
Code	cm ³ /U cm ³ /tr cm ³ /giro in ³ /rev																																																																												
0140	141 / 8.6																																																																												
0170	169 / 10.3																																																																												
0195	195 / 11.9																																																																												
0240	238 / 14.5																																																																												
0280	280 / 17.1																																																																												
0310	310 / 18.9																																																																												
0335	337 / 20.6																																																																												
0405	405 / 24.7																																																																												
0475	477 / 29.1																																																																												
0530	528 / 32.3																																																																												
0625	623 / 38.0																																																																												
0785	786 / 48.0																																																																												
0960	959 / 58.5																																																																												
Code	Mounting																																																																												
A	Front Mtg/Front Bolting 1/2-13 UNC Thd 																																																																												
B	SAE "B" 2 Bolt 																																																																												
C	Rear Mtg/Thru Bolting 																																																																												
Code	Ports																																																																												
S	7/8-14 SAE 																																																																												
M	Manifold 																																																																												
Code	Shaft																																																																												
03	1 1/4" Keyed 																																																																												
05	1 1/4" 14 Tooth Spline 																																																																												
08	1 1/4" Tapered* 																																																																												
19	1 3/8" Tapered* 																																																																												
62	SAE 14 Tooth Spline 																																																																												
Code	Front Port Rotation																																																																												
0	Standard 																																																																												
1	Reverse Timed Manifold 																																																																												
Code	Description																																																																												
AAAB	No Paint No lackiert																																																																												
AAAA	Black Paint Schwarz lackiert																																																																												

For performance data curves, see TG section.

For other available options, see pages 261–262.

Wheel Mount/Radnabengehause
Monture à roue/ Montaje de rueda

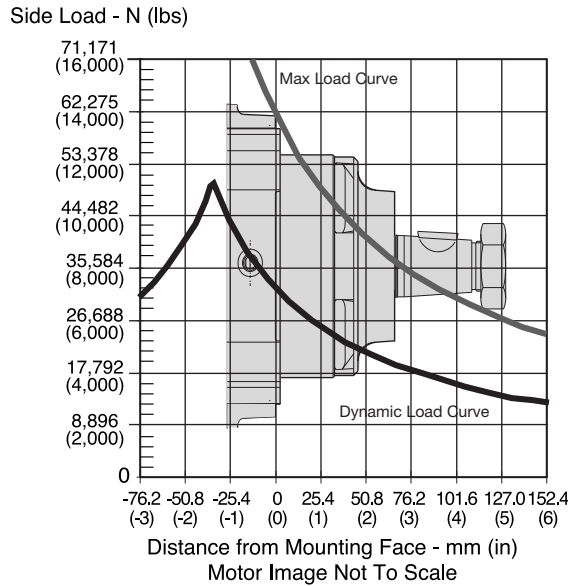

The dynamic side load curve is based on uni-directional steady state loads for L_{10} bearing life at 3×10^6 revolutions.

Die zulässige auslegbare radiale Wellenbelastungskurve ist unter ruhenden, einseitig statisch gerichteten Lastverhältnissen auf eine L_{10} Lebensdauer mit 3×10^6 Umdrehungen kalkuliert.

La courbe de charge latérale permise se base sur des charges unidirectionnelles en régime permanent pour le roulement L_{10} à 3×10^6 révolutions.

La curva de valores admisibles de carga lateral está basada en cargas constantes para cojinetes L_{10} a 3×10^6 revoluciones.

The maximum load curve is defined by bearing static load capacity. This curve should not be exceeded at any time including shock loads.

Die maximale radiale Wellenbelastungskurve ist definiert als maximale statische Last ohne Drehzahl. Sie gilt als Grenze und sollte keinesfalls überschritten werden.

La courbe de charge maximale est définie par la capacité de charge statique portante. Cette courbe ne devrait être dépassée en aucun moment y compris pour les charges par à-coups.

La curva de carga máxima queda definida por la capacidad de carga estática del cojinete. No se deben superar los valores de esta curva, ni siquiera con cargas provisorias de impacto.

Equation to Calculate the Expected Radial Bearing Life
Gleichung zur Ermittlung der Lagerlebensdauer

Equation to calculate the dynamic bearing life for a given load:
Bestimmung der erlaubten radialen Wellenbelastung mit vorgegebener Last

Use F_a , F_b and S in equation to determine hours of L_{10} bearing life.
Die Lebensdauer in Stunden ergibt sich durch einsetzen von F_a , F_b , und S in die nachstehende Formel.

$$L = \frac{3 \times 10^6}{60 \times S} \left\{ \frac{F_a}{F_b} \right\}^{3.33}$$

Where / Mit:

S = Shaft Speed RPM / Abtriebswellendrehzahl in min^{-1}

L = Life In Hours / Lebensdauer in Stunden

F_a = Dynamic side load defined by above curve at a distance from mounting flange. / Erlaubte radiale Wellenbelastung als Function der Laenge

F_b = Application side load. / Anwendungsseitige Wellenbelastung

Note: Calculations are based on L_{10} bearing life per ISO 281.
Auslegung basiert auf einer L_{10} Lebensdauer nach ISO 281

Code: AS

Front Mounting / Front Bolting, 7/8-14 SAE O-Ring

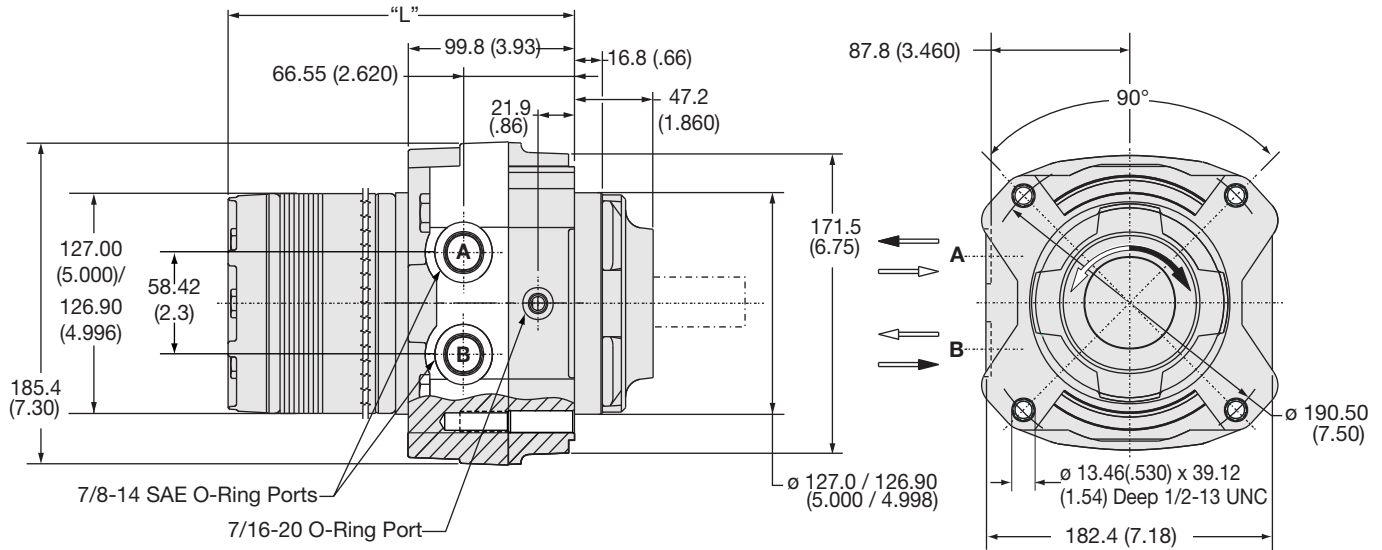

Code AS	0140	0170	0195	0240	0280	0335	0405	0475	0530	0625	0785	0960	
Weight / Gewicht kg	27.3	27.5	27.8	28.1	28.5	28.9	29.5	30.2	30.9	31.7	33.2	34.9	
Poids/Peso (lb)	(60.2)	(60.8)	(61.3)	(62.1)	(63.0)	(63.9)	(65.2)	(66.7)	(68.3)	(69.9)	(73.3)	(77.1)	
Length	"L" mm	192.3	195.3	198.6	203.2	208.0	214.4	221.7	230.4	236.7	246.1	265.2	284.2
	"L" (in)	(7.57)	(7.69)	(7.82)	(8.00)	(8.19)	(8.44)	(8.73)	(9.07)	(9.32)	(9.69)	(10.44)	(11.19)

Code: BM*

SAE "B" 2 Bolt, Manifold

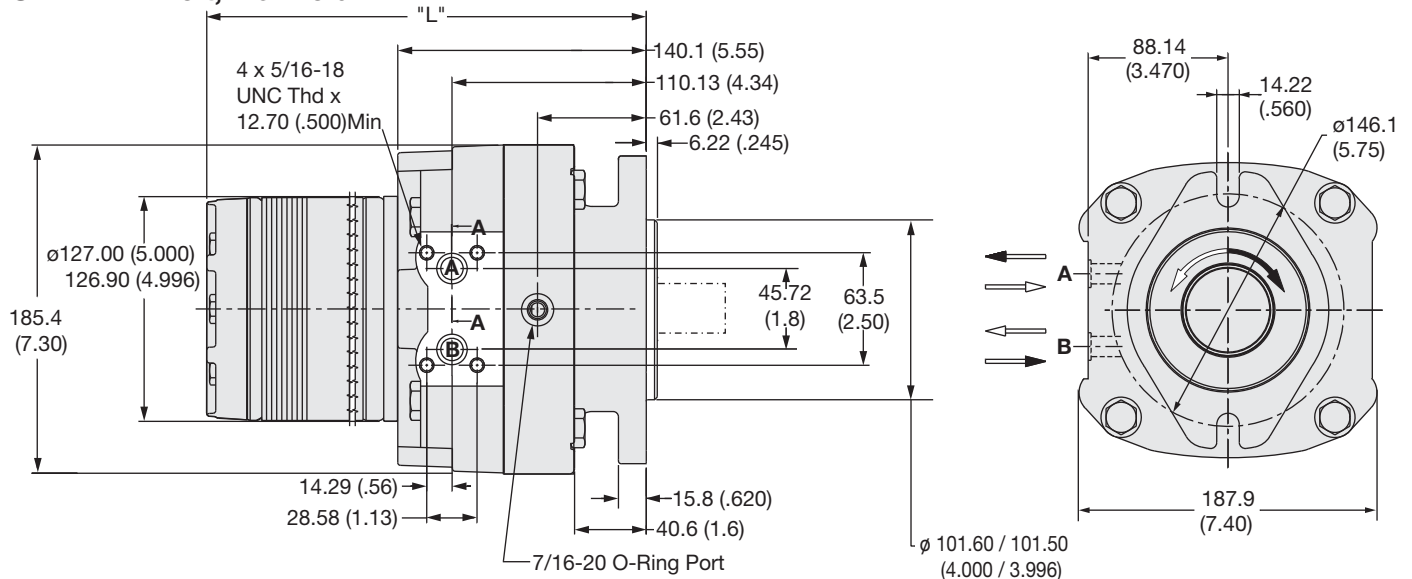

Code BM	0140	0170	0195	0240	0280	0335	0405	0475	0530	0625	0785	0960	
Weight / Gewicht kg	28.4	28.7	28.9	29.3	29.7	30.1	30.1	30.7	31.3	32.8	34.3	36.1	
Poids/Peso (lb)	(62.6)	(63.2)	(63.7)	(64.5)	(65.4)	(66.3)	(67.6)	(69.1)	(70.7)	(72.3)	(75.7)	(79.5)	
Length	"L" mm	233.2	236.4	239.6	244.3	249.1	255.4	262.8	271.3	277.7	287.2	306.3	325.3
	"L" (in)	(9.18)	(9.31)	(9.43)	(9.62)	(9.81)	(10.06)	(10.35)	(10.68)	(10.93)	(11.31)	(12.06)	(12.81)

English equivalents for metric specifications are shown in ().

013 BG Brake.indd, js



Code: CS

Rear Mounting/Thru Bolting, 7/8-14 SAE O-Ring

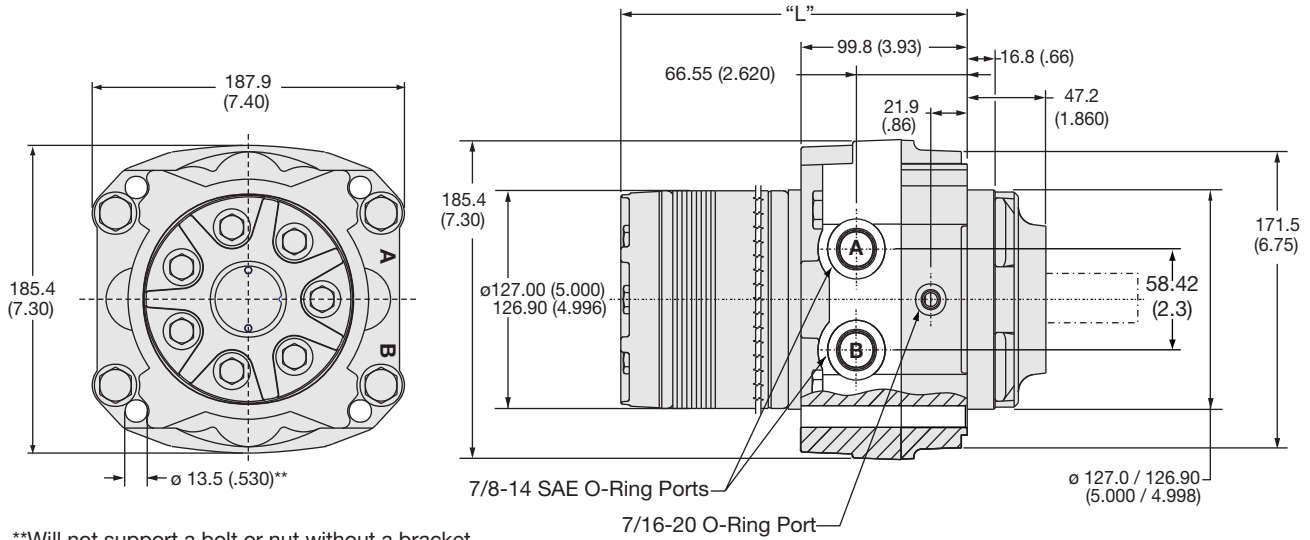

**Will not support a bolt or nut without a bracket.

Code CS	0140	0170	0195	0240	0280	0335	0405	0475	0530	0625	0785	0960
Weight / Gewicht	kg 27.3	27.5	27.8	28.1	28.5	28.9	29.5	30.2	30.9	31.7	33.2	34.9
Poids/Peso	(lb) (60.2)	(60.8)	(61.3)	(62.1)	(63.0)	(63.9)	(65.2)	(66.7)	(68.3)	(69.9)	(73.3)	(77.1)
Length	"L" mm 192.3	195.3	198.6	203.2	208.0	214.4	221.7	230.4	236.7	246.1	265.2	284.2
	"L" (in) (7.57)	(7.69)	(7.82)	(8.00)	(8.19)	(8.44)	(8.73)	(9.07)	(9.32)	(9.69)	(10.44)	(11.19)

***Note:** Motor with manifold mount is supplied with 2 o-rings.

Zum Motor mit Universalanschluß werden 2 o-ringe geliefert.

Deux joints toriques sont livrés avec les moteurs a plan de raccordement universel.

El motor con montaje de distribuidor se suministra con 2 sellos toroidales.

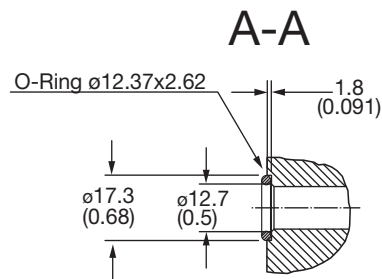

English equivalents for metric specifications are shown in ().

Code A & C

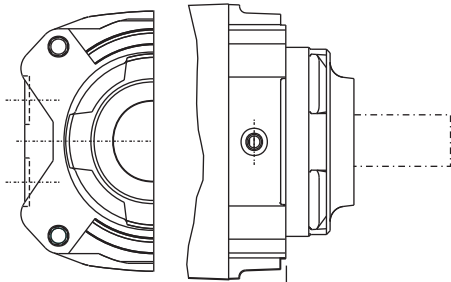

Code B

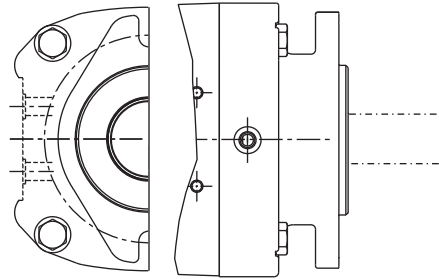

Code: 03

1 1/4" Keyed

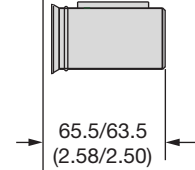
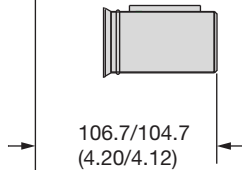

Code: 05

1 1/4" 14 Tooth Spline

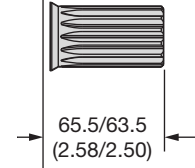
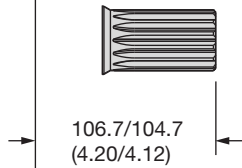

Code: 08

1 1/4" Taper

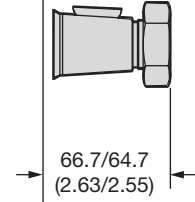
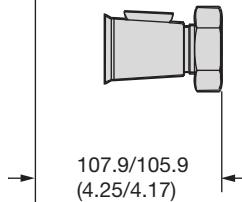

Code: 19

1 3/8" J501 Taper

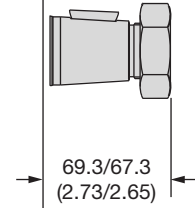
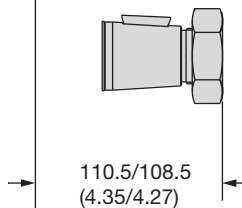

Code: 62

SAE 14 Tooth Spline

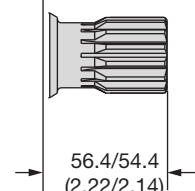
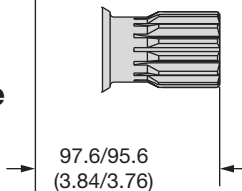

English equivalents for metric specifications are shown in ().

013 BG Brake.indd, js

Code: 03

1 1/4" Keyed

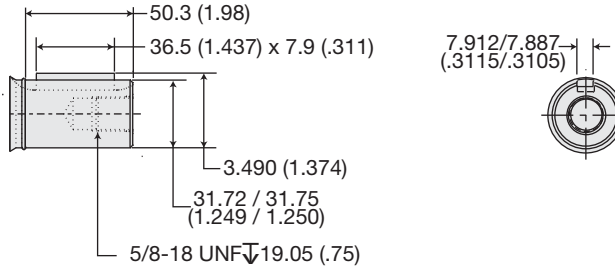

Code: 05

1 1/4" 14 Tooth Spline

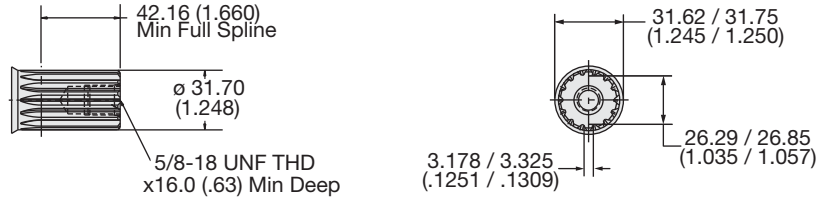

Code: 08

1 1/4" Taper

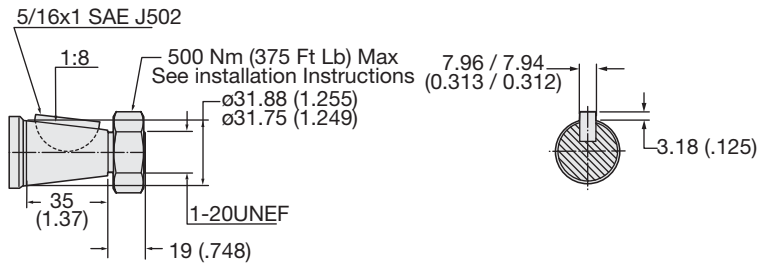

Code: 19

1 3/8" J501 Taper

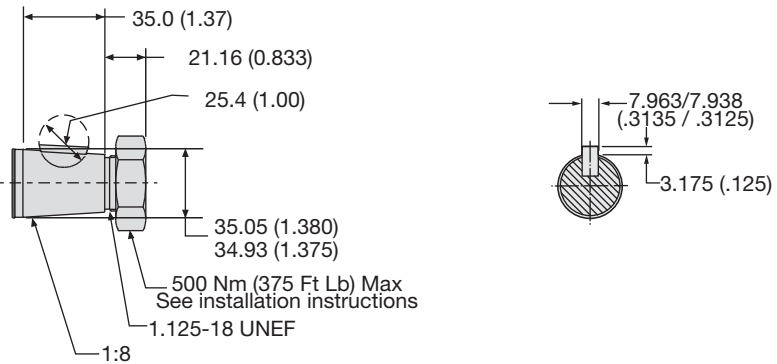

Code: 62

SAE 14 Tooth Spline

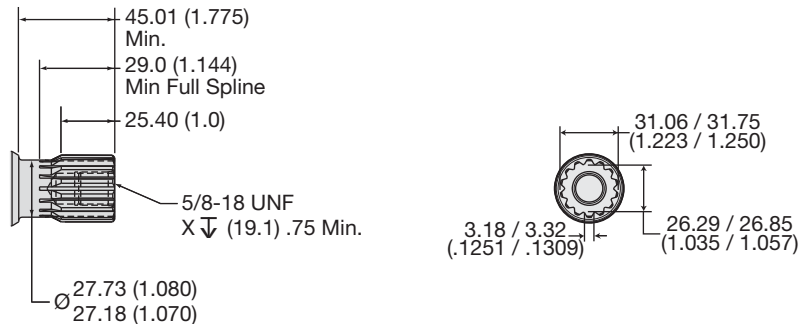

English equivalents for metric specifications are shown in ().

013 BG Brake.indd, js