



## FS7 SERIES

Side wall mounting suction filters

Suction filter for mounting on the tank side wall.  
The shut-off valve allows filter element replacement without opening or emptying the reservoir.  
Flow rates up to 200 l/min.



### HOUSING

tested according to NFPA T3.10.5.1\*, ISO 10771\*, ISO 3968

CONNECTIONS: G 1" - G 1 1/4" - G 1 1/2"  
SAE flange 1 1/2" 3000 psi

MATERIALS: Head: aluminium alloy  
Top cover: PA6 reinforced  
Seal: NBR

BYPASS VALVE: No by-pass or 0,3 bar setting

### ELEMENT

tested according to ISO 11170, 2941, 2942, 2943, 3724, 3968, 16889, 16908, 23181

FILTER MEDIA: Cellulose: C10 - C25  
Wire mesh: T60 - T125 - T250  
Inorganic microfiber: G40

TEMPERATURE RANGE: -30°C +100°C

FLUID COMPATIBILITY: Full with HH-HL-HM-HV  
HETG-HEES (acc. to ISO 6743/4).  
For use with other fluid please  
contact Filtrec Customer Service  
(info@filtrec.it).

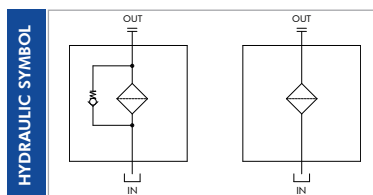

\* as reference method only for verifying the pressure fatigue resistance and establishing the burst pressure ratings.

# OVERALL DIMENSIONS

### SINGLE PORT

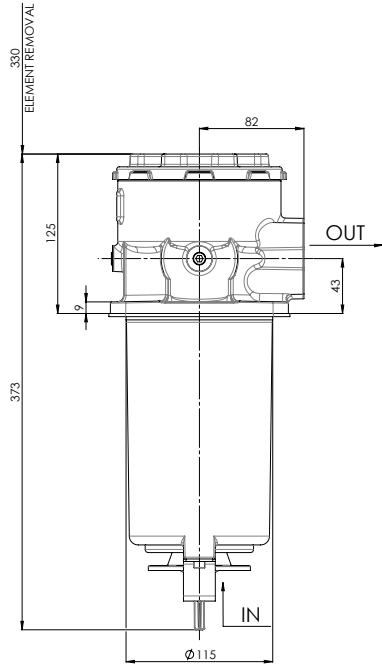

### TRIPLE PORT

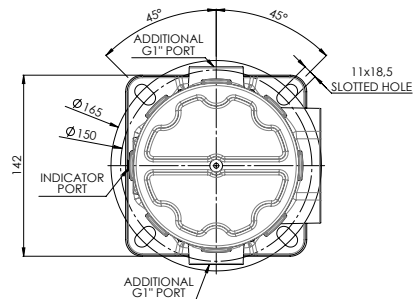
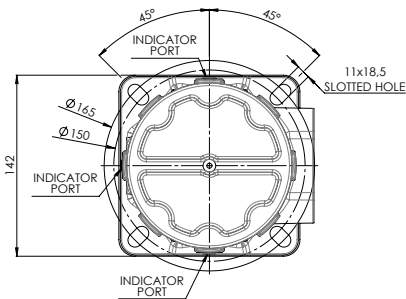
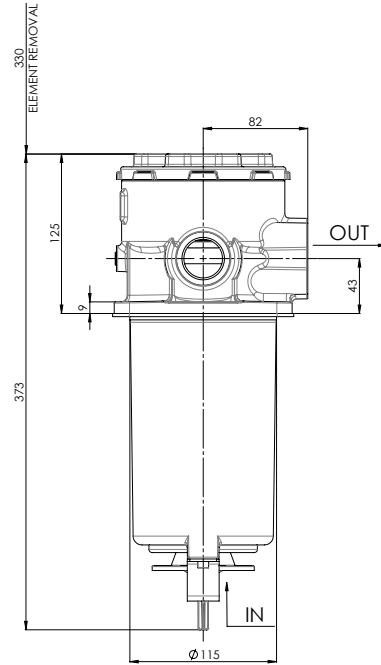

## MAIN PORT OPTIONS - D1

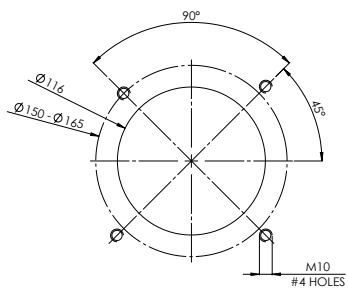

<table border="1"> <tr> <td>B6F7M</td> <td>G1 1/4" + 1 1/2" SAE J518-3000-M12</td> </tr> </table>	B6F7M	G1 1/4" + 1 1/2" SAE J518-3000-M12	<table border="1"> <tr> <td>B7</td> <td>G1 1/2"</td> </tr> </table>	B7	G1 1/2"
B6F7M	G1 1/4" + 1 1/2" SAE J518-3000-M12				
B7	G1 1/2"				

## ORDERING INFORMATION

	1.	2.	3.	4.	5.	6.	7.	8.	9.	10.	11.	12.	13.
	<b>FS7</b>	<b>31</b>	<b>C10</b>	<b>B</b>	<b>B6F7M</b>	<b>B5</b>	<b>B</b>	<b>M</b>	<b>P</b>	<b>PSD</b>	<b>S</b>	<b>0</b>	
SPARE ELEMENT	<b>S7</b>	<b>31</b>	<b>C10</b>										

1. FILTER SERIES	F		
2. FILTER SIZE	S7		
3. FILTER SIZE	31		
4. FILTER MEDIA	000	no element	
	C10	paper $\beta_{10\mu m(c)} > 2$	
	C25	paper $\beta_{25\mu m(c)} > 2$	
	T60	wire mesh 60 $\mu m$	
	T125	wire mesh 125 $\mu m$	
	T250	wire mesh 250 $\mu m$	
	G40	glassfiber $\beta_{35\mu m(c)} > 1.000$	
5. SEALS	*B	NBR	*omitted for spare element
6. MAIN PORT	B6F7M	G 1 1/4"+1 1/2" SAE J518-3000 psi - M12	
	B7	G 1 1/2"	
7. ADDITIONAL PORTS	00	no additional ports	
	B5	2 x G 1"	
8. BYPASS VALVE	0	no bypass	
	B	0,3 bar	
9. MAGNET	0	no magnet	
	M	with magnet	
10. INDICATOR PORT	P	rear	only for "B5"additional port
	T	right + rear + left	only for "00"additional port
11. INDICATOR	000	no indicator	
	MPS	vacuum gauge scale 0÷-1 bar	
	PDS	vacuum switch -0,2 bar SPDT	
12. CORROSION PROTECTION	S	standard	
13. OPTIONS	0	no option	
	1	additional ports 2x G1" plugged	only for "B5"additional port
ACCESSORIES	LC24	LED connector for vacuum switch	

The accessories must be ordered separately

## PRESSURE DROP ( $\Delta p$ ) INFORMATION FOR FILTER SIZING

The total Delta P through a filter assembly is given from Housing  $\Delta p$  + Element  $\Delta p$ .  
The max recommended total  $\Delta p$  for suction filters is 0,15 bar with clean element.

### HOUSING PRESSURE DROP

The housing  $\Delta p$  is given by the curve of the considered model and port, in correspondence of the flow rate value.

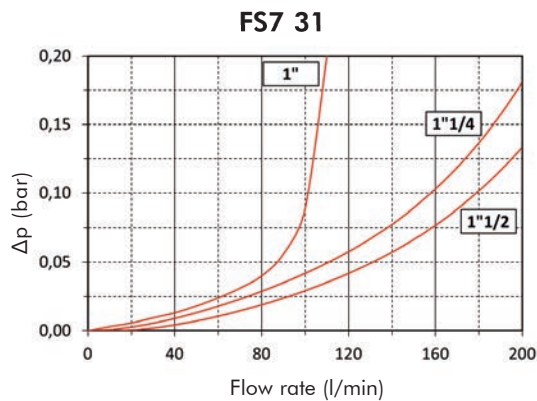

### ELEMENT PRESSURE DROP

The element  $\Delta p$  (bar) is given by the flow rate (l/min) multiplied by the factor in the table here below corresponding to the selected media and divided by 1000.

If the oil has a viscosity  $V_1$  different than 32 cSt a corrective factor  $V_1/32$  must be applied.

Example: 80 l/min with S731T60 and oil viscosity 46 cSt  $> 80 \times 0,075/1000 \times 46/32 = 0,009$  bar

	C10	C25	T60	T125	T250	G40
S731	0,375	0,100	0,075	0,050	0,003	0,110

### EXAMPLE OF TOTAL $\Delta p$ CALCULATION

FS731T60BB700BMTPSD with 80 l/min and oil 46 cSt

Housing  $\Delta p$  0,02 bar + element  $\Delta p$  0,009 bar ( $80 \times 0,075/1000 \times 46/32$ ) = total assembly  $\Delta p$  0,029 bar

### BYPASS VALVE PRESSURE DROP

The bypass valve  $\Delta p$  is given by the curve of the considered model and setting, in correspondence of the flow rate value.

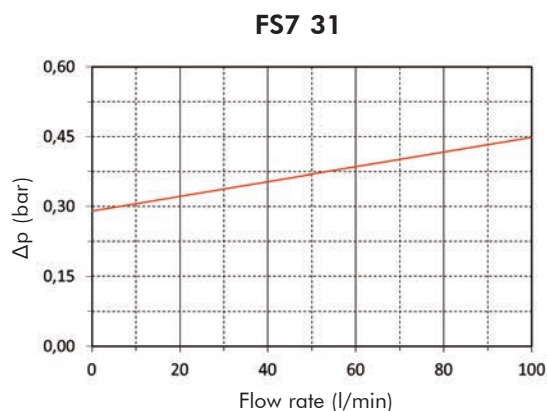

N.B. All the reported data have been obtained at our laboratory, according to specification ISO3968 with mineral oil having 32 cSt viscosity and density  $0,875 \text{ Kg/dm}^3$ .

## USER TIPS



- |                  |           |
|------------------|-----------|
| 1 COVER ASSEMBLY | 4 WASHER  |
| 2 ELEMENT        | 5 STOPPER |
| 3 HOLDER         | 6 HOUSING |

### SPARE SEAL KIT PART NUMBER

NBR	06.021.00312
-----	--------------

### INDICATOR TIGHTENING TORQUE

10 Nm
-------



## WARNING

-  Make sure that Personal Protective Equipment (PPE) is worn during installation and maintenance operation.

## DISPOSAL OF FILTER ELEMENT

-  The used filter elements and the filter parts dirty of oil are classified as "Dangerous waste material": they must be disposed according to the local laws by authorized Companies.



## INSTALLATION

-  1. the filter housing (2) must be properly positioned and well secured on the tank side wall through the fixing holes
-  2. the OUT port must be properly connected to the suction line
3. verify that no tension is present on the filter after mounting
4. enough space must be available for filter element replacement
5. the visual clogging indicator must be in a easily viewable position
6. when a electrical indicator is used, make sure that it is properly wired
7. keep in stock a spare FILTREC filter element for timely replacement when required

## OPERATION

-  1. the filter must work within the operating conditions of pressure, temperature and compatibility given in the first page of this data sheet
2. the filter element must be replaced as soon as the clogging indicator signals at working temperature
3. If no clogging indicator is mounted, replace the element according to the system manufacturer's recommendations

## MAINTENANCE

-  1. before removing the top cover (1) from the housing (2), ensure that the system is switched off and there is no residual pressure in the filter
-  2. unscrew the cover (1) by turning it anticlockwise
3. remove the dirty element (5) by pulling it carefully
4. fit a new FILTREC element(5), verifying the part number, particularly concerning the micron rating
6. check the seal (4) conditions and replace if necessary
7. lubricate the threads and screw completely the cover (1) in the filter housing by turning it clockwise
8. the used filter elements cannot be cleaned and re-used

