



FLAT FACE

ISO 16028 - FLAT FACE

Available other different threads on request

Edition. 21.6

CS Carbon Steel

- Type: Quick Couplings
- Models: ISO 16028 FLAT FACE
- Sizes: from DN6 to DN25
- Pressure: up to PN420
- Treatment: Zinc-Nickel

SS Stainless Steel

- Type: Quick Couplings
- Models: ISO 16028 FLAT FACE
- Sizes: from DN6 to DN25
- Pressure: up to PN420

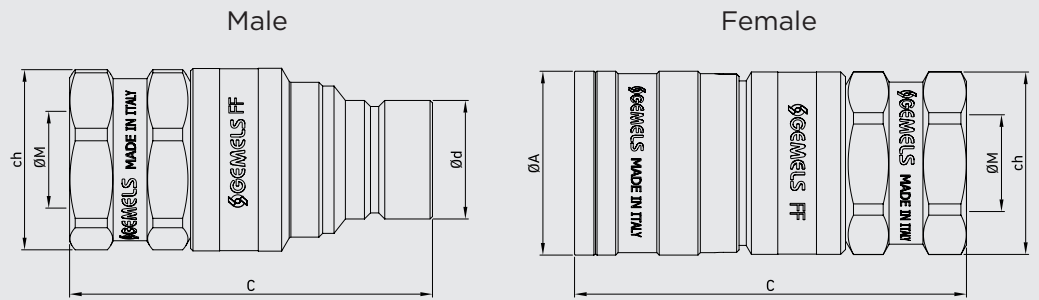

Available also in patented version: ball valve with integrated quick coupling.

Performance

(1/4", 3/8", 1/2", 5/8", 3/4", 1")
 Series (1/4", 3/8", 1/2", 5/8", 3/4", 1")
 200SUS (Test Fluid: Oil-200SUS)

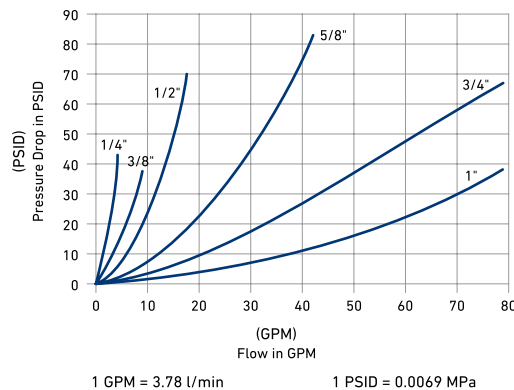



CODE DESCRIPTION STRUCTURE

									QC	G1/2	M/F	DN12,5	1	B
Type of coupling														
ISO 16028 FF														
Ends														
ISO 1179-1 BSPP	ISO 8434-6 BSPP	ASME B1.20.1 NPT	ISO 11926-1 (SAE J1926-1) ORB	ISO 8434-1-S (DIN 2353)	ISO 8434-1-L (DIN 2353)	ISO 8434-1-S (DIN 2353) BULKHEAD	ISO 8434-1-L (DIN 2353) BULKHEAD	8434-2 (SAE J514) JIC						
G 1/4	G 1/4	N 1/4	SAE4	8S	8L	8S	8L	J 3/8						
G 3/8	G 3/8	N 3/8	SAE6	12S	10L	12S	10L	J 5/8						
G 1/2	G 1/2	N 1/2	SAE12	16S	12L	16S	12L	J 1/2						
G 3/4	G 3/4	N 3/4	SAE16	25S	15L	20S	15L	J 3/4						
G 1	G 1	N 1	SAE20		18L	25S	18L	J 1						
G 1 1/4	G 1 1/4	N 1 1/4	SAE24											
MALE														
FEMALE														
DN/ISO														
6,3														
10														
12,5														
16														
19														
25														
Body Material														
● 1 = 1,0737														
● 4 = 1,4404														
Seal material														
● B = NBR E = FKM*														
● E = FKM														

*On request

- Plugs
- Caps

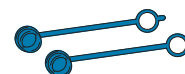

Available colours:

- Blue
- Yellow
- Red
- Green

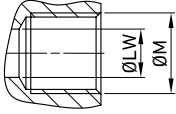

**QUICK COUPLINGS ISO 16028 FLAT FACE (male / female)
FEMALE THREAD ISO 1179-1 BSPP**

										CS Carbon Steel											CS Carbon Steel
TYPE	DN	PN	ØA	C	Ød	ch	ØM	WEIGHT	ITEM CODE	TYPE	DN	PN	ØA	C	Ød	ch	ØM	WEIGHT	ITEM CODE		
QC FF G 1/4 MALE	6.3	MPa 42	mm - 48	16,15	24	G1/4		kg 0,09	NC05G010000	QC FF G 3/4 MALE	19	MPa 35	mm - 88,5	29,95	41	G3/4		kg 0,48	NC05G040005		
		Psi 6090	inch - 1,89	0,64	0,94			Psi 5075				inch - 3,48	1,18	1,61	lb 1,06						
QC FF G 1/4 FEMALE	6.3	MPa 42	mm 27	61,5	- 24	G1/4		kg 0,151	NC06G010000	QC FF G 3/4 FEMALE	19	MPa 35	mm 44	99	- 41	G3/4		kg 0,78	NC06G040005		
		Psi 6090	inch 1,06	2,42	- 0,94			Psi 5075				inch 1,73	3,90	- 1,61	lb 1,72						
QC FF G 3/8 MALE	10	MPa 42	mm - 65,5	19,75	30	G3/8		kg 0,11	NC05G020000	QC FF G 1 MALE	19	MPa 35	mm - 92	29,95	41	G1		kg 0,436	NC05G050000		
		Psi 6090	inch - 2,58	0,78	1,18			Psi 5075				inch - 3,62	1,18	1,61	lb 0,96						
QC FF G 3/8 FEMALE	10	MPa 42	mm 31	75	- 30	G3/8		kg 0,29	NC06G020000	QC FF G 1 FEMALE	19	MPa 35	mm 44	103	- 41	G1		kg 0,733	NC06G050000		
		Psi 6090	inch 1,22	2,95	- 1,18			Psi 5075				inch 1,73	4,06	- 1,61	lb 1,62						
QC FF G 1/2 MALE	10	MPa 42	mm - 69,5	19,75	30	G1/2		kg 0,13	NC05G030000	QC FF G 1 MALE	25	MPa 35	mm - 100	36	50	G1		kg 0,58	NC05G050002		
		Psi 6090	inch - 2,74	0,78	1,18			Psi 5075				inch - 3,94	1,42	1,97	lb 1,28						
QC FF G 1/2 FEMALE	10	MPa 42	mm 31	79	- 30	G1/2		kg 0,25	NC06G030000	QC FF G 1 FEMALE	25	MPa 35	mm 54,5	100	- 50	G1		kg 1,25	NC06G050002		
		Psi 6090	inch 1,22	3,11	- 1,18			Psi 5075				inch 2,15	3,94	- 1,97	lb 2,76						
QC FF G 1/2 MALE	12.5	MPa 42	mm - 75	24,5	34	G1/2		kg 0,317	NC05G030003	QC FF G 1 1/4 MALE	25	MPa 35	mm - 103	36	50	G1 1/4		kg 0,696	NC05G060000		
		Psi 6090	inch - 2,95	0,96	1,34			Psi 5075				inch - 4,06	1,42	1,97	lb 1,53						
QC FF G 1/2 FEMALE	12.5	MPa 42	mm 38	81	- 34	G1/2		kg 0,377	NC06G030003	QC FF G 1 1/4 FEMALE	25	MPa 35	mm 54,5	103	- 50	G1 1/4		kg 1,323	NC06G060000		
		Psi 6090	inch 1,50	3,19	- 1,34			Psi 5075				inch 2,15	4,06	- 1,97	lb 2,92						
QC FF G 3/4 MALE	12.5	MPa 42	mm - 77,5	24,5	34	G3/4		kg 0,291	NC05G040000	QC FF G 1 1/2 MALE	25	MPa 35	mm - 103	36	55	G1 1/2		kg 0,75	NC05G070000		
		Psi 6090	inch - 3,05	0,96	1,34			Psi 5075				inch - 4,06	1,42	2,17	lb 1,65						
QC FF G 3/4 FEMALE	12.5	MPa 42	mm 38	85	- 34	G3/4		kg 0,411	NC06G040000	QC FF G 1 1/2 FEMALE	25	MPa 35	mm 54,5	103	- 55	G1 1/2		kg 1,53	NC06G070000		
		Psi 6090	inch 1,50	3,33	- 1,34			Psi 5075				inch 2,15	4,06	- 2,17	lb 3,37						
QC FF G 1/2 MALE	16	MPa 35	mm - 80	27	41	G1/2		kg 0,4	NC05G030004	ABOVE ISO 25 G 1.1/2" : ON REQUEST											
Psi 5075		inch - 3,15	1,06	1,61	lb 0,88																
QC FF G 1/2 FEMALE	16	MPa 35	mm 42	87	- 41	G1/2		kg 0,52	NC06G030004												
Psi 5075		inch 1,65	3,43	- 1,61	lb 1,15																
QC FF G 5/8 MALE	16	MPa 35	mm - 81	27	41	G5/8		kg 0,35	NC05GA30000												
Psi 5075		inch - 3,19	1,06	1,61	lb 0,77																
QC FF G 5/8 FEMALE	16	MPa 35	mm 42	88	- 41	G5/8		kg 0,49	NC06GA30000												
Psi 5075		inch 1,65	3,46	- 1,61	lb 1,08																
QC FF G 3/4 MALE	16	MPa 35	mm - 83,5	27	41	G3/4		kg 0,3	NC05G040004												
Psi 5075		inch - 3,29	1,06	1,61	lb 0,66																
QC FF G 3/4 FEMALE	16	MPa 35	mm 42	91	- 41	G3/4		kg 0,47	NC06G040004												
Psi 5075		inch 1,65	3,58	- 1,61	lb 1,04																
QC FF G 1 MALE	16	MPa 35	mm - 87	27	41	G1		kg 0,45	NC05G050003												
Psi 5075		inch - 3,43	1,06	1,61	lb 0,99																
QC FF G 1 FEMALE	16	MPa 35	mm 42	95	- 41	G1		kg 0,6	NC06G050003												
Psi 5075		inch 1,65	3,74	- 1,61	lb 1,32																

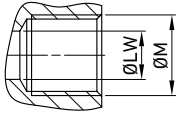

QUICK COUPLINGS ISO 16028 FLAT FACE (male / female) FEMALE THREAD ISO 1179-1 BSPP

										SS Stainless Steel											SS Stainless Steel
TYPE	DN	PN	ØA	C	Ød	ch	ØM	WEIGHT	ITEM CODE	TYPE	DN	PN	ØA	C	Ød	ch	ØM	WEIGHT	ITEM CODE		
QC FF G 1/4 MALE	6.3	MPa 42	mm -	48	16,15	24	G1/4	kg 0,09	NC05G01S000	QC FF G 3/4 MALE	19	MPa 35	mm -	88,5	29,95	41	G3/4	kg 0,48	NC05G04S000		
		Psi 6090	inch -	1,89	0,64	0,94		Psi 5075				inch -	3,48	1,18	1,61	lb 1,06					
QC FF G 1/4 FEMALE	6.3	MPa 42	mm 27	61,5	-	24	G1/4	kg 0,151	NC06G01S000	QC FF G 3/4 FEMALE	19	MPa 35	mm 44	99	-	41	G3/4	kg 0,78	NC06G04S000		
		Psi 6090	inch 1,06	2,42	-	0,94		Psi 5075				inch 1,73	3,90	-	1,61	lb 1,72					
QC FF G 3/8 MALE	10	MPa 42	mm -	65,5	19,75	30	G3/8	kg 0,11	NC05G020001	QC FF G 1 MALE	25	MPa 35	mm -	92	29,95	41	G1	kg 0,436	NC05G050001		
		Psi 6090	inch -	2,58	0,78	1,18		Psi 5075				inch -	3,62	1,18	1,61	lb 0,96					
QC FF G 3/8 FEMALE	10	MPa 42	mm 31	75	-	30	G3/8	kg 0,29	NC06G020001	QC FF G 1 FEMALE	25	MPa 35	mm 44	103	-	41	G1	kg 0,733	NC06G050001		
		Psi 6090	inch 1,22	2,95	-	1,18		Psi 5075				inch 1,73	4,06	-	1,61	lb 1,62					
QC FF G 1/2 MALE	12.5	MPa 42	mm -	69,5	19,75	30	G1/2	kg 0,13	NC05G02S000	QC FF G 1 MALE	25	MPa 35	mm -	100	36	50	G1	kg 0,58	NC05G05S000		
		Psi 6090	inch -	2,74	0,78	1,18		Psi 5075				inch -	3,94	1,42	1,97	lb 1,28					
QC FF G 1/2 FEMALE	12.5	MPa 42	mm 31	79	-	30	G1/2	kg 0,25	NC06G02S000	QC FF G 1 FEMALE	25	MPa 35	mm 54,5	100	-	50	G1	kg 1,25	NC06G05S000		
		Psi 6090	inch 1,22	3,11	-	1,18		Psi 5075				inch 2,15	3,94	-	1,97	lb 2,76					
QC FF G 1/2 MALE	12.5	MPa 42	mm -	75	24,5	34	G1/2	kg 0,317	NC05G030002	QC FF G 1 1/4 MALE	25	MPa 35	mm -	103	36	50	G1 1/4	kg 0,696	NC05G060001		
		Psi 6090	inch -	2,95	0,96	1,34		Psi 5075				inch -	4,06	1,42	1,97	lb 1,53					
QC FF G 1/2 FEMALE	12.5	MPa 42	mm 38	81	-	34	G1/2	kg 0,377	NC06G030002	QC FF G 1 1/4 FEMALE	25	MPa 35	mm 54,5	103	-	50	G1 1/4	kg 1,323	NC06G060001		
		Psi 6090	inch 1,50	3,19	-	1,34		Psi 5075				inch 2,15	4,06	-	1,97	lb 2,92					
QC FF G 3/4 MALE	16	MPa 42	mm -	77,5	24,5	34	G3/4	kg 0,291	NC05G03S000	QC FF G 1 1/2 MALE	25	MPa 35	mm -	103	36	55	G1 1/2	kg 0,75	NC05G05S001		
		Psi 6090	inch -	3,05	0,96	1,34		Psi 5075				inch -	4,06	1,42	2,17	lb 1,65					
QC FF G 3/4 FEMALE	16	MPa 42	mm 38	85	-	34	G3/4	kg 0,411	NC06G03S000	QC FF G 1 1/2 FEMALE	25	MPa 35	mm 54,5	103	-	55	G1 1/2	kg 1,53	NC06G05S001		
		Psi 6090	inch 1,50	0,33	-	1,34		Psi 5075				inch 2,15	4,06	-	2,17	lb 3,37					
QC FF G 1/2 MALE	16	MPa 35	mm -	81	27	41	G5/8	kg 0,35	NC05GA3S000	ABOVE ISO 25 G 1.1/2" : ON REQUEST											
		Psi 5075	inch -	3,19	1,06	1,61		lb 0,77													
QC FF G 1/2 FEMALE	16	MPa 35	mm 42	88	-	41	G5/8	kg 0,49	NC06GA3S000												
		Psi 5075	inch 1,65	3,46	-	1,61		lb 1,08													
QC FF G 5/8 MALE	16	MPa 35	mm -	80	27	41	G1/2	kg 0,4	NC05GA3S001												
		Psi 5075	inch -	3,15	1,06	1,61		lb 0,88													
QC FF G 5/8 FEMALE	16	MPa 35	mm 42	87	-	41	G1/2	kg 0,52	NC06GA3S001												
		Psi 5075	inch 1,65	3,43	-	1,61		lb 1,15													
QC FF G 3/4 MALE	16	MPa 35	mm -	83,5	27	41	G3/4	kg 0,3	NC05G040002												
		Psi 5075	inch -	3,29	1,06	1,61		lb 0,66													
QC FF G 3/4 FEMALE	16	MPa 35	mm 42	91	-	41	G3/4	kg 0,47	NC06G040002												
		Psi 5075	inch 1,65	3,58	-	1,61		lb 1,04													
QC FF G 1 MALE	16	MPa 35	mm -	87	27	41	G1	kg 0,45	NC05GA3S002												
		Psi 5075	inch -	3,43	1,06	1,61		lb 0,99													
QC FF G 1 FEMALE	16	MPa 35	mm 42	95	-	41	G1	kg 0,6	NC06GA3S002												
		Psi 5075	inch 1,65	3,74	-	1,61		lb 1,32													

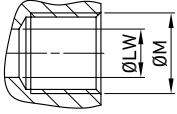

**QUICK COUPLINGS ISO 16028 FLAT FACE (male / female)
FEMALE THREAD ISO 7-1 BSPT**

										CS Carbon Steel											CS Carbon Steel
TYPE	DN	PN	ØA	C	Ød	ch	ØM	WEIGHT	ITEM CODE	TYPE	DN	PN	ØA	C	Ød	ch	ØM	WEIGHT	ITEM CODE		
QC FF G 1/4 MALE	6,3	MPa 42	mm - 48	16,15	24		Rc 1/4	kg 0,107	NC05P010000	QC FF G 3/4 MALE	19	MPa 35	mm - 87,5	29,95	41		Rc 3/4	kg 0,48	NC05P040005		
		Psi 6090	inch - 1,89	0,64	0,94			lb 0,24				Psi 5075	inch - 3,44	1,18	1,61			lb 1,06			
QC FF G 1/4 FEMALE	6,3	MPa 42	mm 27	61,5	- 24		Rc 1/4	kg 0,357	NC06P010000	QC FF G 3/4 FEMALE	19	MPa 35	mm 44	98	- 41		Rc 3/4	kg 0,78	NC06P040005		
		Psi 6090	inch 1,06	2,42	- 0,94			lb 0,79				Psi 5075	inch 1,73	3,86	- 1,61			lb 1,72			
QC FF G 3/8 MALE	10	MPa 42	mm - 65,5	19,75	30		Rc 3/8	kg 0,216	NC05P020000	QC FF G 1 MALE	19	MPa 35	mm - 92	29,95	41		Rc 1	kg 0,436	NC05P050000		
		Psi 6090	inch - 2,58	0,78	1,18			lb 0,48				Psi 5075	inch - 3,62	1,18	1,61			lb 0,96			
QC FF G 3/8 FEMALE	10	MPa 42	mm 31	75	- 30		Rc 3/8	kg 0,593	NC06P020000	QC FF G 1 FEMALE	19	MPa 35	mm 44	103	- 41		Rc 1	kg 0,733	NC06P050000		
		Psi 6090	inch 1,22	2,95	- 1,18			lb 1,31				Psi 5075	inch 1,73	4,06	- 1,61			lb 1,62			
QC FF G 1/2 MALE	10	MPa 42	mm - 69,5	19,75	30		Rc 1/2	kg 0,217	NC05P030000	QC FF G 1 MALE	25	MPa 35	mm - 100	36	50		Rc 1	kg 0,58	NC05P050002		
		Psi 6090	inch - 2,74	0,78	1,18			lb 0,48				Psi 5075	inch - 3,94	1,42	1,97			lb 1,28			
QC FF G 1/2 FEMALE	10	MPa 42	mm 31	79	- 30		Rc 1/2	kg 0,595	NC06P030000	QC FF G 1 FEMALE	25	MPa 35	mm 54,5	100	- 50		Rc 1	kg 1,25	NC06P050002		
		Psi 6090	inch 1,22	3,11	- 1,18			lb 1,31				Psi 5075	inch 2,15	3,94	- 1,97			lb 2,76			
QC FF G 1/2 MALE	12,5	MPa 42	mm - 75	24,5	34		Rc 1/2	kg 0,344	NC05P030003	QC FF G 1 1/4 MALE	25	MPa 35	mm - 102	36	50		Rc 1	kg 0,696	NC05P060000		
		Psi 6090	inch - 2,95	0,96	1,34			lb 0,76				Psi 5075	inch - 4,02	1,42	1,97			lb 1,53			
QC FF G 1/2 FEMALE	12,5	MPa 42	mm 38	81	- 34		Rc 1/2	kg 0,521	NC06P030003	QC FF G 1 1/4 FEMALE	25	MPa 35	mm 54,5	102	- 50		Rc 1	kg 1,323	NC06P060000		
		Psi 6090	inch 1,50	3,19	- 1,34			lb 1,15				Psi 5075	inch 2,15	4,02	- 1,97			lb 2,92			
QC FF G 3/4 MALE	12,5	MPa 42	mm - 77	24,5	34		Rc 3/4	kg 0,324	NC05P040000	QC FF G 1 1/2 MALE	25	MPa 35	mm - 102	36	55		Rc 1	kg 0,75	NC05P070000		
		Psi 6090	inch - 3,03	0,96	1,34			lb 0,71				Psi 5075	inch - 4,02	1,42	2,17			lb 1,65			
QC FF G 3/4 FEMALE	12,5	MPa 42	mm 38	83	- 34		Rc 3/4	kg 0,501	NC06P040000	QC FF G 1 1/2 FEMALE	25	MPa 35	mm 54,5	102	- 55		Rc 1	kg 1,53	NC06P070000		
		Psi 6090	inch 1,50	3,27	- 1,34			lb 1,10				Psi 5075	inch 2,15	4,02	- 2,17			lb 3,37			
QC FF G 1/2 MALE	16	MPa 35	mm - 82	27	41		Rc 1/2	kg 0,456	NC05P030004	ABOVE ISO 25 G 1.1/2" : ON REQUEST											
Psi 5075		inch - 3,23	1,06	1,61			lb 1,01														
QC FF G 1/2 FEMALE	16	MPa 35	mm 42	89	- 41		Rc 1/2	kg 0,532	NC06P030004												
		Psi 5075	inch 1,65	3,50	- 1,61			lb 1,17													
QC FF G 3/4 MALE	16	MPa 35	mm - 82,5	27	41		Rc 3/4	kg 0,279	NC05P040004												
		Psi 5075	inch - 3,25	1,06	1,61			lb 0,62													
QC FF G 3/4 FEMALE	16	MPa 35	mm 42	90	41		Rc 3/4	kg 0,435	NC06P040004												
		Psi 5075	inch 1,65	3,54	0,00	1,61		lb 0,96													
QC FF G 1 MALE	16	MPa 35	mm - 87	27	41		Rc 1	kg 0,45	NC05P050003												
		Psi 5075	inch - 3,43	1,06	1,61			lb 0,99													
QC FF G 1 FEMALE	16	MPa 35	mm 42	95	- 41		Rc 1	kg 0,6	NC06P050003												
		Psi 5075	inch 1,65	3,74	- 1,61			lb 1,32													

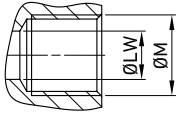

QUICK COUPLINGS ISO 16028 FLAT FACE (male / female) FEMALE THREAD ISO 7-1 BSPT

										SS Stainless Steel											SS Stainless Steel
TYPE	DN	PN	ØA	C	Ød	ch	ØM	WEIGHT	ITEM CODE	TYPE	DN	PN	ØA	C	Ød	ch	ØM	WEIGHT	ITEM CODE		
QC FF G 1/4 MALE	6,3	MPa 42	mm - 48	16,15	24	Rc 1/4		kg 0,107	NC05P01S000	QC FF G 3/4 MALE	19	MPa 35	mm - 87,5	29,95	41	Rc 3/4		kg 0,48	NC05P04S000		
		Psi 6090	inch - 1,89	0,64	0,94			Psi 5075				inch - 3,44	1,18	1,61	lb 1,06						
QC FF G 1/4 FEMALE	6,3	MPa 42	mm 27	61,5	- 24	Rc 1/4		kg 0,357	NC06P01S000	QC FF G 3/4 FEMALE	19	MPa 35	mm 44	98	- 41	Rc 3/4		kg 0,78	NC06P04S000		
		Psi 6090	inch 1,06	2,42	- 0,94			Psi 5075				inch 1,73	3,86	- 1,61	lb 1,72						
QC FF G 3/8 MALE	10	MPa 42	mm - 65,5	19,75	30	Rc 3/8		kg 0,216	NC05P020001	QC FF G 1 MALE	19	MPa 35	mm - 92	29,95	41	Rc 1		kg 0,436	NC05P050001		
		Psi 6090	inch - 2,58	0,78	1,18			Psi 5075				inch - 3,62	1,18	1,61	lb 0,96						
QC FF G 3/8 FEMALE	10	MPa 42	mm 31	75	- 30	Rc 3/8		kg 0,593	NC06P020001	QC FF G 1 FEMALE	19	MPa 35	mm 44	103	- 41	Rc 1		kg 0,733	NC06P050001		
		Psi 6090	inch 1,22	2,95	- 1,18			Psi 5075				inch 1,73	4,06	- 1,61	lb 1,62						
QC FF G 1/2 MALE	10	MPa 42	mm - 69,5	19,75	30	Rc 1/2		kg 0,217	NC05P02S000	QC FF G 1 MALE	19	MPa 35	mm - 100	36	50	Rc 1		kg 0,58	NC05P05S000		
		Psi 6090	inch - 2,74	0,78	1,18			Psi 5075				inch - 3,94	1,42	1,97	lb 1,28						
QC FF G 1/2 FEMALE	10	MPa 42	mm 31	79	- 30	Rc 1/2		kg 0,595	NC06P02S000	QC FF G 1 FEMALE	19	MPa 35	mm 54,5	100	- 50	Rc 1		kg 1,25	NC06P05S000		
		Psi 6090	inch 1,22	3,11	- 1,18			Psi 5075				inch 2,15	3,94	- 1,97	lb 2,76						
QC FF G 1/2 MALE	12,5	MPa 42	mm - 75	24,5	34	Rc 1/2		kg 0,344	NC05P030002	QC FF G 1 1/4 MALE	25	MPa 35	mm - 102	36	50	Rc 1	1/4	kg 0,696	NC05P060001		
		Psi 6090	inch - 2,95	0,96	1,34			Psi 5075				inch - 4,02	1,42	1,97	lb 1,53						
QC FF G 1/2 FEMALE	12,5	MPa 42	mm 38	81	- 34	Rc 1/2		kg 0,521	NC06P030002	QC FF G 1 1/4 FEMALE	25	MPa 35	mm 54,5	102	- 50	Rc 1	1/4	kg 1,323	NC06P060001		
		Psi 6090	inch 1,50	3,19	- 1,34			Psi 5075				inch 2,15	4,02	- 1,97	lb 2,92						
QC FF G 3/4 MALE	12,5	MPa 42	mm - 77	24,5	34	Rc 3/4		kg 0,324	NC05P03S000	QC FF G 1 1/2 MALE	25	MPa 35	mm - 102	36	55	Rc 1		kg 0,75	NC05P05S001		
		Psi 6090	inch - 3,03	0,96	1,34			Psi 5075				inch - 4,02	1,42	2,17	lb 1,65						
QC FF G 3/4 FEMALE	12,5	MPa 42	mm 38	83	- 34	Rc 3/4		kg 0,501	NC06P03S000	QC FF G 1 1/2 FEMALE	25	MPa 35	mm 54,5	102	- 55	Rc 1		kg 1,53	NC06P05S001		
		Psi 6090	inch 1,50	3,27	- 1,34			Psi 5075				inch 2,15	4,02	- 2,17	lb 3,37						
QC FF G 1/2 MALE	16	MPa 35	mm - 82	27	41	Rc 1/2		kg 0,456	NC05PA3S000	ABOVE ISO 25 G 1.1/2" : ON REQUEST											
		Psi 5075	inch - 3,23	1,06	1,61			lb 1,01													
QC FF G 1/2 FEMALE	16	MPa 35	mm 42	89	- 41	Rc 1/2		kg 0,532	NC06PA3S000												
		Psi 5075	inch 1,65	3,50	- 1,61			lb 1,17													
QC FF G 3/4 MALE	16	MPa 35	mm - 82,5	27	41	Rc 3/4		kg 0,279	NC05P040002												
		Psi 5075	inch - 3,25	1,06	1,61			lb 0,62													
QC FF G 3/4 FEMALE	16	MPa 35	mm 42	90	- 41	Rc 3/4		kg 0,435	NC06P040002												
		Psi 5075	inch 1,65	3,54	- 1,61			lb 0,96													
QC FF G 1 MALE	16	MPa 35	mm - 87	27	41	Rc 1	1/4	kg 0,45	NC05PA3S002												
		Psi 5075	inch - 3,43	1,06	1,61			lb 0,99													
QC FF G 1 FEMALE	16	MPa 35	mm 42	95	- 41	Rc 1		kg 0,6	NC06PA3S002												
		Psi 5075	inch 1,65	3,74	- 1,61			lb 1,32													

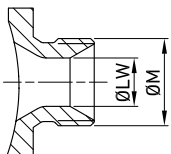
**QUICK COUPLINGS ISO 16028 FLAT FACE (male / female)
MALE THREAD ISO 8434-6 BSPP**
CS

Carbon Steel

TYPE	DN	PN	ØA	C	Ød	ch	ØM	ØLW	WEIGHT	ITEM CODE
QC FF G 1/4M MALE	6,3	MPa 42	mm -	53,5	16,15	24	G1/4	4,7	kg 0,29	NC05E010000
		Psi 6090	inch -	2,11	0,64	0,94		0,19	lb 0,64	
QC FF G 1/4M FEMALE	6,3	MPa 42	mm 27	67	-	24	G1/4	4,7	kg 0,351	NC06E010000
		Psi 6090	inch 1,06	2,64	-	0,94		0,19	lb 0,77	
QC FF G 3/8M MALE	10	MPa 42	mm -	72	19,75	30	G3/8	7,9	kg 0,31	NC05E020000
		Psi 6090	inch -	2,83	0,78	1,18		0,31	lb 0,68	
QC FF G 3/8M FEMALE	10	MPa 42	mm 31	81,7	-	30	G3/8	7,9	kg 0,49	NC06E020000
		Psi 6090	inch 1,22	3,22	-	1,18		0,31	lb 1,08	
QC FF G 1/2M MALE	10	MPa 42	mm -	74	19,75	30	G1/2	11,1	kg 0,33	NC05E030000
		Psi 6090	inch -	2,91	0,78	1,18		0,44	lb 0,73	
QC FF G 1/2M FEMALE	10	MPa 42	mm 31	83,7	-	30	G1/2	11,1	kg 0,45	NC06E030000
		Psi 6090	inch 1,22	3,30	-	1,18		0,44	lb 0,99	
QC FF G 1/2M MALE	12,5	MPa 42	mm -	77	24,5	34	G1/2	11,1	kg 0,517	NC05E030003
		Psi 6090	inch -	3,03	0,96	1,34		0,44	lb 1,14	
QC FF G 1/2M FEMALE	12,5	MPa 42	mm 38	83	-	34	G1/2	11,1	kg 0,577	NC06E030003
		Psi 6090	inch 1,50	3,27	-	1,34		0,44	lb 1,27	
QC FF G 3/4M MALE	12,5	MPa 42	mm -	79	24,5	34	G3/4	16,7	kg 0,491	NC05E040000
		Psi 6090	inch -	3,11	0,96	1,34		0,66	lb 1,08	
QC FF G 3/4M FEMALE	12,5	MPa 42	mm 38	85	-	34	G3/4	16,7	kg 0,611	NC06E040000
		Psi 6090	inch 1,50	3,35	-	1,34		0,66	lb 1,35	
QC FF G 5/8M MALE	16	MPa 35	mm -	86	27	41	G5/8	14,3	kg 0,55	NC05EA30000
		Psi 5075	inch -	3,39	1,06	1,61		0,56	lb 1,21	
QC FF G 5/8M FEMALE	16	MPa 35	mm 42	94	-	41	G5/8	14,3	kg 0,69	NC06EA30000
		Psi 5075	inch 1,65	3,70	-	1,61		0,56	lb 1,52	
QC FF G 3/4M MALE	16	MPa 35	mm -	86	27	41	G3/4	16,7	kg 0,5	NC05E040004
		Psi 5075	inch -	3,39	1,06	1,61		0,66	lb 1,10	
QC FF G 3/4M FEMALE	16	MPa 35	mm 42	94	-	41	G3/4	16,7	kg 0,67	NC06E040004
		Psi 5075	inch 1,65	3,70	-	1,61		0,66	lb 1,48	
QC FF G 3/4M MALE	19	MPa 35	mm -	91	29,95	41	G3/4	16,7	kg 0,68	NC05E040005
		Psi 5075	inch -	3,58	1,18	1,61		0,66	lb 1,50	
QC FF G 3/4M FEMALE	19	MPa 35	mm 44	102	-	41	G3/4	16,7	kg 0,98	NC06E040005
		Psi 5075	inch 1,73	4,02	-	1,61		0,66	lb 2,16	
QC FF G 1M MALE	19	MPa 35	mm -	94	29,95	41	G1	22,2	kg 0,636	NC05E050000
		Psi 5075	inch -	3,70	1,18	1,61		0,87	lb 1,40	
QC FF G 1M FEMALE	19	MPa 35	mm 44	105	-	41	G1	22,2	kg 0,933	NC06E050000
		Psi 5075	inch 1,73	4,13	-	1,61		0,87	lb 2,06	
QC FF G 1M MALE	25	MPa 35	mm -	106	36	50	G1	22,2	kg 0,78	NC05E050002
		Psi 5075	inch -	4,17	1,42	1,97		0,87	lb 1,72	
QC FF G 1M FEMALE	25	MPa 35	mm 54,5	106	-	50	G1	22,2	kg 1,45	NC06E050002
		Psi 5075	inch 2,15	4,17	-	1,97		0,87	lb 3,20	
QC FF G 1 1/4M MALE	25	MPa 35	mm -	107	36	50	G1 1/4	28,6	kg 0,896	NC05E060000
		Psi 5075	inch -	4,21	1,42	1,97		1,13	lb 1,98	
QC FF G 1 1/4M FEMALE	25	MPa 35	mm 54,5	107	-	50	G1 1/4	28,6	kg 1,523	NC06E060000
		Psi 5075	inch 2,15	4,21	-	1,97		1,13	lb 3,36	
QC FF G 1 1/2M MALE	25	MPa 35	mm -	109	36	55	G1 1/2	33,3	kg 0,95	NC05E070000
		Psi 5075	inch -	4,29	1,42	2,17		1,31	lb 2,09	
QC FF G 1 1/2M FEMALE	25	MPa 35	mm 54,5	109	-	55	G1 1/2	33,3	kg 1,73	NC06E070000
		Psi 5075	inch 2,15	4,29	-	2,17		1,31	lb 3,81	

ABOVE ISO 25 G 1.1/2" : ON REQUEST

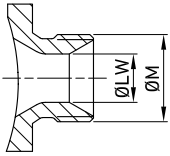

QUICK COUPLINGS ISO 16028 FLAT FACE (male / female) MALE THREAD ISO 8434-6 BSPP

SS
Stainless Steel

TYPE	DN	PN	ØA	C	Ød	ch	ØM	ØLW	WEIGHT	ITEM CODE	
QC FF G 1/4M MALE	6,3	MPa 42	mm -	53,5	16,15	24	G1/4	4,7	kg 0,29	NC05E01S000	
		Psi 6090	inch -	2,11	0,64	0,94		0,19	lb 0,64		
QC FF G 1/4M FEMALE	6,3	MPa 42	mm 27	67	-	24	G1/4	4,7	kg 0,351	NC06E01S000	
		Psi 6090	inch 1,06	2,64	-	0,94		0,19	lb 0,77		
QC FF G 3/8M MALE	10	MPa 42	mm -	72	19,75	30	G3/8	7,9	kg 0,31	NC05E02S000	
		Psi 6090	inch -	2,83	0,78	1,18		0,31	lb 0,68		
QC FF G 3/8M FEMALE		10	MPa 42	mm 31	81,7	-	30	G3/8	7,9	kg 0,49	NC06E02S000
			Psi 6090	inch 1,22	3,22	-	1,18		0,31	lb 1,08	
QC FF G 1/2M MALE		10	MPa 42	mm -	74	19,75	30	G1/2	11,1	kg 0,33	NC05E02S001
			Psi 6090	inch -	2,91	0,78	1,18		0,44	lb 0,73	
QC FF G 1/2M EMALE	10	MPa 42	mm 31	83,7	-	30	G1/2	11,1	kg 0,45	NC06E02S001	
		Psi 6090	inch 1,22	3,30	-	1,18		0,44	lb 0,99		
QC FF G 1/2M MALE	12,5	MPa 42	mm -	77	24,5	34	G1/2	11,1	kg 0,517	NC05E03S000	
		Psi 6090	inch -	3,03	0,96	1,34		0,44	lb 1,14		
QC FF G 1/2M FEMALE		12,5	MPa 42	mm 38	83	-	34	G1/2	11,1	kg 0,577	NC06E03S000
			Psi 6090	inch 1,50	3,27	-	1,34		0,44	lb 1,27	
QC FF G 3/4M MALE		12,5	MPa 42	mm -	79	24,5	34	G3/4	16,7	kg 0,491	NC05E03S001
			Psi 6090	inch -	3,11	0,96	1,34		0,66	lb 1,08	
QC FF G 3/4M FEMALE	12,5		MPa 42	mm 38	85	-	34	G3/4	16,7	kg 0,611	NC06E03S001
			Psi 6090	inch 1,50	3,35	-	1,34		0,66	lb 1,35	
QC FF G 5/8M MALE	16		MPa 35	mm -	86	27	41	G5/8	14,3	kg 0,55	NC05EA3S000
			Psi 5075	inch -	3,39	1,06	1,61		0,56	lb 1,21	
QC FF G 5/8M FEMALE		16	MPa 35	mm 42	94	-	41	G5/8	14,3	kg 0,69	NC06EA3S000
			Psi 5075	inch 1,65	-	1,61	-		0,56	lb 1,52	
QC FF G 3/4M MALE		16	MPa 35	mm -	86	27	41	G3/4	16,7	kg 0,5	NC05E04S001
			Psi 5075	inch -	3,39	1,06	1,61		0,66	lb 1,10	
QC FF G 3/4M FEMALE	16		MPa 35	mm 42	94	-	41	G3/4	16,7	kg 0,67	NC06E04S001
			Psi 5075	inch 1,65	3,70	-	1,61		0,66	lb 1,48	
QC FF G 3/4M MALE	19		MPa 35	mm -	91	29,95	41	G3/4	16,7	kg 0,68	NC05E04S000
			Psi 5075	inch -	3,58	1,18	1,61		0,66	lb 1,50	
QC FF G 3/4M FEMALE		19	MPa 35	mm 44	102	-	41	G3/4	16,7	kg 0,98	NC06E04S000
			Psi 5075	inch 1,73	4,02	-	1,61		0,66	lb 2,16	
QC FF G 1M MALE		19	MPa 35	mm -	94	29,95	41	G1	22,2	kg 0,636	NC05E05S001
			Psi 5075	inch -	3,70	1,18	1,61		0,87	lb 1,40	
QC FF G 1M FEMALE	19		MPa 35	mm 44	105	-	41	G1	22,2	kg 0,933	NC06E05S001
			Psi 5075	inch 1,73	4,13	-	1,61		0,87	lb 2,06	
QC FF G 1M MALE	25		MPa 35	mm -	106	36	50	G1	22,2	kg 0,78	NC05E05S000
			Psi 5075	inch -	4,17	1,42	1,97		0,87	lb 1,72	
QC FF G 1M FEMALE		25	MPa 35	mm 54,5	106	-	50	G1	22,2	kg 1,45	NC06E05S000
			Psi 5075	inch 2,15	4,17	-	1,97		0,87	lb 3,20	
QC FF G 1 1/4M MALE		25	MPa 35	mm -	107	36	50	G1 1/4	28,6	kg 0,896	NC05E06S000
			Psi 5075	inch -	4,21	1,42	1,97		1,13	lb 1,98	
QC FF G 1 1/4M FEMALE	25		MPa 35	mm 54,5	107	-	50	G1 1/4	28,6	kg 1,523	NC06E06S000
			Psi 5075	inch 2,15	4,21	-	1,97		1,13	lb 3,36	
QC FF G 1 1/2M MALE	25		MPa 35	mm -	109	36	55	G1 1/2	33,3	kg 0,95	NC05E05S002
			Psi 5075	inch -	4,29	1,42	2,17		1,31	lb 2,09	
QC FF G 1 1/2M FEMALE	25	MPa 35	mm 54,5	109	-	55	G1 1/2	33,3	kg 1,73	NC06E05S002	
		Psi 5075	inch 2,15	4,29	-	2,17		1,31	lb 3,81		

ABOVE ISO 25 G 1.1/2" : ON REQUEST

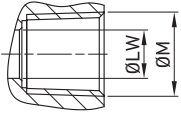

**QUICK COUPLINGS ISO 16028 FLAT FACE (male / female)
FEMALE THREAD ASME B1.20.1 NPT**

										CS Carbon Steel											CS Carbon Steel
TYPE	DN	PN	ØA	C	Ød	ch	ØM	WEIGHT	ITEM CODE	TYPE	DN	PN	ØA	C	Ød	ch	ØM	WEIGHT	ITEM CODE		
QC FF N 1/4 MALE	6.3	MPa 42	mm -	49,5	16,15	24	N1/4	kg 0,09	NC05N010000	QC FF N 3/4 MALE	19	MPa 35	mm -	88,5	29,95	41	N3/4	kg 0,48	NC05N040005		
		Psi 6090	inch -	1,95	0,64	0,94		Psi 5075				inch -	3,48	1,18	1,61	lb 1,06					
QC FF N 1/4 FEMALE	6.3	MPa 42	mm	27	63	- 24	N1/4	kg 0,151	NC06N010000	QC FF N 3/4 FEMALE	19	MPa 35	mm	44	99	- 41	N3/4	kg 0,78	NC06N040005		
		Psi 6090	inch	1,06	2,48	- 0,94		Psi 5075				inch	1,73	3,90	- 1,61	lb 1,72					
QC FF N 3/8 MALE	10	MPa 42	mm -	67,5	19,75	30	N3/8	kg 0,11	NC05N020000	QC FF N 1 MALE	19	MPa 35	mm -	92	29,95	41	N1	kg 0,436	NC05N050000		
		Psi 6090	inch -	2,66	0,78	1,18		Psi 5075				inch -	3,62	1,18	1,61	lb 0,96					
QC FF N 3/8 FEMALE	10	MPa 42	mm	31	77	- 30	N3/8	kg 0,29	NC06N020000	QC FF N 1 FEMALE	19	MPa 35	mm	44	99	- 41	N1	kg 0,733	NC06N050000		
		Psi 6090	inch	1,22	3,03	- 1,18		Psi 5075				inch	1,73	3,90	- 1,61	lb 1,62					
QC FF N 1/2 MALE	10	MPa 42	mm -	72	19,75	30	N1/2	kg 0,13	NC05N030000	QC FF N 1 MALE	25	MPa 35	mm -	100	36	50	N1	kg 0,58	NC05N050002		
		Psi 6090	inch -	2,83	0,78	1,18		Psi 5075				inch -	3,94	1,42	1,97	lb 1,28					
QC FF N 1/2 FEMALE	10	MPa 42	mm	31	82	- 30	N1/2	kg 0,25	NC06N030000	QC FF N 1 FEMALE	25	MPa 35	mm	54,5	100	- 50	N1	kg 1,25	NC06N050002		
		Psi 6090	inch	1,22	3,23	- 1,18		Psi 5075				inch	2,15	3,94	- 1,97	lb 2,76					
QC FF N 1/2 MALE	12.5	MPa 42	mm -	75	24,5	34	N1/2	kg 0,317	NC05N030003	QC FF N 1.1/4 MALE	25	MPa 35	mm -	103	36	50	N1 1/4	kg 0,696	NC05N060000		
		Psi 6090	inch -	2,95	0,96	1,34		Psi 5075				inch -	4,06	1,42	1,97	lb 1,53					
QC FF N 1/2 FEMALE	12.5	MPa 42	mm	38	81	- 34	N1/2	kg 0,377	NC06N030003	QC FF N 1.1/4 FEMALE	25	MPa 35	mm	54,5	103	- 50	N1 1/4	kg 1,323	NC06N060000		
		Psi 6090	inch	1,50	3,19	- 1,34		Psi 5075				inch	2,15	4,06	- 1,97	lb 2,92					
QC FF N 3/4 MALE	12.5	MPa 42	mm -	78	24,5	34	N3/4	kg 0,291	NC05N040000	QC FF N 1.1/2 MALE	25	MPa 35	mm -	103	36	55	N1 1/2	kg 0,75	NC05N070000		
		Psi 6090	inch -	3,07	0,96	1,34		Psi 5075				inch -	4,06	1,42	2,17	lb 1,65					
QC FF N 3/4 FEMALE	12.5	MPa 42	mm	38	84	- 34	N3/4	kg 0,411	NC06N040000	QC FF N 1.1/2 FEMALE	25	MPa 35	mm	54,5	103	- 55	N1 1/2	kg 1,53	NC06N070000		
		Psi 6090	inch	1,50	3,31	- 1,34		Psi 5075				inch	2,15	4,06	- 2,17	lb 3,37					
QC FF N 1/2 MALE	16	MPa 35	mm -	82	27	41	N1/2	kg 0,4	NC05N030004	ABOVE ISO 25 G 1.1/2" : ON REQUEST											
		Psi 5075	inch -	3,23	1,06	1,61		lb 0,88													
QC FF N 1/2 FEMALE	16	MPa 35	mm	42	87	41 -	N1/2	kg 0,52	NC06N030004	ABOVE ISO 25 G 1.1/2" : ON REQUEST											
		Psi 5075	inch	1,65	3,43	1,61 -		lb 1,15													
QC FF N 3/4 MALE	16	MPa 35	mm -	83,5	27	41	N3/4	kg 0,3	NC05N040004	ABOVE ISO 25 G 1.1/2" : ON REQUEST											
		Psi 5075	inch -	3,29	1,06	1,61		lb 0,66													
QC FF N 3/4 FEMALE	16	MPa 35	mm	42	91	- 41	N3/4	kg 0,47	NC06N040004	ABOVE ISO 25 G 1.1/2" : ON REQUEST											
		Psi 5075	inch	1,65	3,58	- 1,61		lb 1,04													
QC FF N 1 MALE	16	MPa 35	mm -	87	27	41	N1	kg 0,45	NC05N050003	ABOVE ISO 25 G 1.1/2" : ON REQUEST											
		Psi 5075	inch -	3,43	1,06	1,61		lb 0,99													
QC FF N 1 FEMALE	16	MPa 35	mm	42	95	- 41	N1	kg 0,6	NC06N050003	ABOVE ISO 25 G 1.1/2" : ON REQUEST											
		Psi 5075	inch	1,65	3,74	- 1,61		lb 1,32													

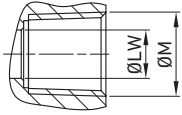

QUICK COUPLINGS ISO 16028 FLAT FACE (male / female) FEMALE THREAD ASME B1.20.1 NPT

										SS Stainless Steel											SS Stainless Steel
TYPE	DN	PN	ØA	C	Ød	ch	ØM	WEIGHT	ITEM CODE	TYPE	DN	PN	ØA	C	Ød	ch	ØM	WEIGHT	ITEM CODE		
QC FF N 1/4 MALE	6.3	MPa 42	mm -	49,5	16,15	24	N1/4	kg 0,09	NC05N01S000	QC FF N 3/4 MALE	19	MPa 35	mm -	88,5	29,95	41	N3/4	kg 0,48	NC05N04S000		
		Psi 6090	inch -	1,95	0,64	0,94		Psi 5075				inch -	3,48	1,18	1,61	lb 1,06					
QC FF N 1/4 FEMALE	6.3	MPa 42	mm 27	63	-	24	N1/4	kg 0,151	NC06N01S000	QC FF N 3/4 FEMALE	19	MPa 35	mm 44	99	-	41	N3/4	kg 0,78	NC06N04S000		
		Psi 6090	inch 1,06	2,48	-	0,94		Psi 5075				inch 1,73	3,90	-	1,61	lb 1,72					
QC FF N 3/8 MALE	10	MPa 42	mm -	67,5	19,75	30	N3/8	kg 0,11	NC05N02S000	QC FF N 1 MALE	19	MPa 35	mm -	92	29,95	41	N1	kg 0,436	NC05N04S001		
		Psi 6090	inch -	2,66	0,78	1,18		Psi 5075				inch -	3,62	1,18	1,61	lb 0,96					
QC FF N 3/8 FEMALE	10	MPa 42	mm 31	77	-	30	N3/8	kg 0,29	NC06N02S000	QC FF N 1 FEMALE	19	MPa 35	mm 44	99	-	41	N1	kg 0,733	NC06N04S001		
		Psi 6090	inch 1,22	3,03	-	1,18		Psi 5075				inch 1,73	3,90	-	1,61	lb 1,62					
QC FF N 1/2 MALE	10	MPa 42	mm -	72	19,75	30	N1/2	kg 0,13	NC05N02S001	QC FF N 1 MALE	25	MPa 35	mm -	100	36	50	N1	kg 0,58	NC05N05S000		
		Psi 6090	inch -	2,83	0,78	1,18		Psi 5075				inch -	3,94	1,42	1,97	lb 1,28					
QC FF N 1/2 FEMALE	10	MPa 42	mm 31	82	-	30	N1/2	kg 0,25	NC06N02S001	QC FF N 1 FEMALE	25	MPa 35	mm 54,5	100	-	50	N1	kg 1,25	NC06N05S000		
		Psi 6090	inch 1,22	3,23	-	1,18		Psi 5075				inch 2,15	3,94	-	1,97	lb 2,76					
QC FF N 1/2 MALE	12.5	MPa 42	mm -	75	24,5	34	N1/2	kg 0,317	NC05N03S000	QC FF N 1.1/4 MALE	25	MPa 35	mm -	103	36	50	N1 1/4	kg 0,696	NC05N05S001		
		Psi 6090	inch -	2,95	0,96	1,34		Psi 5075				inch -	4,06	1,42	1,97	lb 1,53					
QC FF N 1/2 FEMALE	12.5	MPa 42	mm 38	81	-	34	N1/2	kg 0,377	NC06N03S000	QC FF N 1.1/4 FEMALE	25	MPa 35	mm 54,5	103	-	50	N1 1/4	kg 1,323	NC06N05S001		
		Psi 6090	inch 1,50	3,19	-	1,34		Psi 5075				inch 2,15	4,06	-	1,97	lb 2,92					
QC FF N 3/4 MALE	12.5	MPa 42	mm -	78	24,5	34	N3/4	kg 0,291	NC05N03S001	QC FF N 1.1/2 MALE	25	MPa 35	mm -	103	36	55	N1 1/2	kg 0,75	NC05N05S002		
		Psi 6090	inch -	3,07	0,96	1,34		Psi 5075				inch -	4,06	1,42	2,17	lb 1,65					
QC FF N 3/4 FEMALE	12.5	MPa 42	mm 38	84	-	34	N3/4	kg 0,411	NC06N03S001	QC FF N 1.1/2 FEMALE	25	MPa 35	mm 54,5	103	-	55	N1 1/2	kg 1,53	NC06N05S002		
		Psi 6090	inch 1,50	3,31	-	1,34		Psi 5075				inch 2,15	4,06	-	2,17	lb 3,37					
QC FF N 1/2 MALE	16	MPa 35	mm -	82	27	41	N1/2	kg 0,4	NC05NA3S000	ABOVE ISO 25 G 1.1/2" : ON REQUEST											
		Psi 5075	inch -	3,23	1,06	1,61		lb 0,88													
QC FF N 1/2 FEMALE	16	MPa 35	mm 42	87	41	-	N1/2	kg 0,52	NC06NA3S000												
		Psi 5075	inch 1,65	3,43	1,61	-		lb 1,15													
QC FF N 3/4 MALE	16	MPa 35	mm -	83,5	27	41	N3/4	kg 0,3	NC05NA3S001												
		Psi 5075	inch -	3,29	1,06	1,61		lb 0,66													
QC FF N 3/4 FEMALE	16	MPa 35	mm 42	91	-	41	N3/4	kg 0,47	NC06NA3S001												
		Psi 5075	inch 1,65	3,58	-	1,61		lb 1,04													
QC FF N 1 MALE	16	MPa 35	mm -	87	27	41	N1	kg 0,45	NC05NA3S002												
		Psi 5075	inch -	3,43	1,06	1,61		lb 0,99													
QC FF N 1 FEMALE	16	MPa 35	mm 42	95	-	41	N1	kg 0,6	NC06NA3S002												
		Psi 5075	inch 1,65	3,74	-	1,61		lb 1,32													

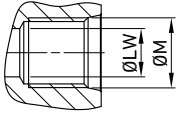

**QUICK COUPLINGS ISO 16028 FLAT FACE (male / female)
FEMALE THREAD ISO 11926-1 (SAE J1926-1) ORB**

										CS Carbon Steel											CS Carbon Steel
TYPE	DN	PN	ØA	C	Ød	ch	ØM	WEIGHT	ITEM CODE	TYPE	DN	PN	ØA	C	Ød	ch	ØM	WEIGHT	ITEM CODE		
QC FF SAE4 MALE	6.3	MPa 42	mm - 48	16,15	24	7/16-	kg 0,09	NC05S010000	QC FF SAE12 MALE	19	MPa 35	mm - 92	29,95	41	1-1/16-	kg 0,48	NC05S040005				
		Psi 6090	inch - 1,89	0,64	0,94	20 UNF	lb 0,20				Psi 5075	inch - 3,62	1,18	1,61	12 UN	lb 1,06					
QC FF SAE4 FEMALE	6.3	MPa 42	mm 27	61,5	- 24	7/16-	kg 0,151	NC06S010000	QC FF SAE12 FEMALE	19	MPa 35	mm 44	103	- 41	1-1/16-	kg 0,78	NC06S040005				
		Psi 6090	inch 1,06	2,42	- 0,94	20 UNF	lb 0,33				Psi 5075	inch 1,73	4,06	- 1,61	12 UN	lb 1,72					
QC FF SAE6 MALE	6.3	MPa 42	mm - 49	16,15	24	9/16-	kg 0,22	NC05S010001	QC FF SAE16 MALE	25	MPa 35	mm - 92	29,95	41	1-5/16-	kg 0,7	NC05S050000				
		Psi 6090	inch - 1,93	0,64	0,94	18 UNF	lb 0,49				Psi 5075	inch - 3,62	1,18	1,61	12 UN	lb 1,54					
QC FF SAE6 FEMALE	6.3	MPa 42	mm 27	62,5	- 24	9/16-	kg 0,35	NC06S010001	QC FF SAE16 FEMALE	25	MPa 35	mm 44	103	- 41	1-5/16-	kg 0,85	NC06S050000				
		Psi 6090	inch 1,06	2,46	- 0,94	18 UNF	lb 0,77				Psi 5075	inch 1,73	4,06	- 1,61	12 UN	lb 1,87					
QC FF SAE6 MALE	10	MPa 42	mm - 66,5	19,75	30	9/16-	kg 0,11	NC05S020000	QC FF SAE16 MALE	25	MPa 35	mm - 100	36	50	1-5/16-	kg 0,58	NC05S050002				
		Psi 6090	inch - 2,62	0,78	1,18	18 UNF	lb 0,24				Psi 5075	inch - 3,94	1,42	1,97	12 UN	lb 1,28					
QC FF SAE6 FEMALE	10	MPa 42	mm 31	76	- 30	9/16-	kg 0,29	NC06S020000	QC FF SAE16 FEMALE	25	MPa 35	mm 54,5	100	- 50	1-5/16-	kg 1,25	NC06S050002				
		Psi 6090	inch 1,22	2,99	- 1,18	18 UNF	lb 0,64				Psi 5075	inch 2,15	3,94	- 1,97	12 UN	lb 2,76					
QC FF SAE8 MALE	10	MPa 42	mm - 69,5	19,75	30	3/4-16	kg 0,13	NC05S030000	QC FF SAE20 MALE	25	MPa 35	mm - 103	36	50	1-5/8-	kg 0,696	NC05S060000				
		Psi 6090	inch - 2,74	0,78	1,18	UNF	lb 0,29				Psi 5075	inch - 4,06	1,42	1,97	12 UN	lb 1,53					
QC FF SAE8 FEMALE	10	MPa 42	mm 31	79	- 30	3/4-16	kg 0,25	NC06S030000	QC FF SAE20 FEMALE	25	MPa 35	mm 54,5	103	- 50	1-5/8-	kg 1,323	NC06S060000				
		Psi 6090	inch 1,22	3,11	- 1,18	UNF	lb 0,55				Psi 5075	inch 2,15	4,06	- 1,97	12 UN	lb 2,92					
QC FF SAE8 MALE	12,5	MPa 42	mm - 75	24,5	34	3/4-16	kg 0,317	NC05S030003	QC FF SAE8 FEMALE	12,5	MPa 42	mm 38	81	- 34	3/4-16	kg 0,377	NC06S030003				
		Psi 6090	inch - 2,95	0,96	1,34	UNF	lb 0,70				Psi 6090	inch 1,50	3,19	- 1,34	UNF	lb 0,83					
QC FF SAE12 MALE	12,5	MPa 42	mm - 80,5	24,5	34	1-1/16-	kg 0,291	NC05S040000	QC FF SAE12 FEMALE	12,5	MPa 42	mm 38	86,5	- 34	1-1/16-	kg 0,411	NC06S040000				
		Psi 6090	inch - 3,17	0,96	1,34	12 UN	lb 0,64				Psi 6090	inch 1,50	3,41	- 1,34	12 UN	lb 0,91					
QC FF SAE8 MALE	16	MPa 35	mm - 80	27	41	3/4-16	kg 0,4	NC05S030004	QC FF SAE8 FEMALE	16	MPa 35	mm 42	87	- 41	3/4-16	kg 0,52	NC06S030004				
		Psi 5075	inch - 3,15	1,06	1,61	UNF	lb 0,88				Psi 5075	inch 1,65	3,43	- 1,61	UNF	lb 1,15					
QC FF SAE12 MALE	16	MPa 35	mm - 85	27	41	1-1/16-	kg 0,3	NC05S040004	QC FF SAE12 FEMALE	16	MPa 35	mm 42	93	- 41	1-1/16-	kg 0,47	NC06S040004				
		Psi 5075	inch - 3,35	1,06	1,61	12 UN	lb 0,66				Psi 5075	inch 1,65	3,66	- 1,61	12 UN	lb 1,04					

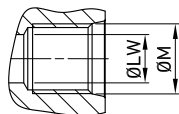

QUICK COUPLINGS ISO 16028 FLAT FACE (male / female) FEMALE THREAD ISO 11926-1 (SAE J1926-1) ORB

									SS Stainless Steel										SS Stainless Steel
TYPE	DN	PN	ØA	C	Ød	ch	ØM	WEIGHT	ITEM CODE	TYPE	DN	PN	ØA	C	Ød	ch	ØM	WEIGHT	ITEM CODE
QC FF SAE4 MALE	6.3	MPa 42	mm - 48	16,15	24	7/16-	kg 0,09	NC05S01S000	QC FF SAE12 MALE	19	MPa 35	mm - 92	29,95	41	1-1/16-	kg 0,48	NC05S04S000		
		Psi 6090	inch - 1,89	0,64	0,94	20 UNF	lb 0,20				Psi 5075	inch - 3,62	1,18	1,61	12 UN	lb 1,06			
QC FF SAE4 FEMALE	6.3	MPa 42	mm 27	61,5	- 24	7/16-	kg 0,151	NC06S01S000	QC FF SAE12 FEMALE	19	MPa 35	mm 44	103	- 41	1-1/16-	kg 0,78	NC06S04S000		
		Psi 6090	inch 1,06	2,42	- 0,94	20 UNF	lb 0,33				Psi 5075	inch 1,73	4,06	- 1,61	12 UN	lb 1,72			
QC FF SAE6 MALE	6.3	MPa 42	mm - 49	16,15	24	9/16-	kg 0,22	NC05S01S001	QC FF SAE16 MALE	19	MPa 35	mm - 92	29,95	41	1 5/16-	kg 0,7	NC05S05S002		
		Psi 6090	inch - 1,93	0,64	0,94	18 UNF	lb 0,49				Psi 5075	inch - 3,62	1,18	1,61	-12 UN	lb 1,54			
QC FF SAE6 FEMALE	6.3	MPa 42	mm 27	62,5	- 24	9/16-	kg 0,35	NC06S01S001	QC FF SAE16 FEMALE	19	MPa 35	mm 44	103	- 41	1 5/16-	kg 0,85	NC06S05S002		
		Psi 6090	inch 1,06	2,46	- 0,94	18 UNF	lb 0,77				Psi 5075	inch 1,73	4,06	- 1,61	-12 UN	lb 1,87			
QC FF SAE6 MALE	10	MPa 42	mm - 66,5	19,75	30	9/16-	kg 0,11	NC05S02S000	QC FF SAE16 MALE	25	MPa 35	mm - 100	36	50	1-5/16-	kg 0,58	NC05S05S000		
		Psi 6090	inch - 2,62	0,78	1,18	18 UNF	lb 0,24				Psi 5075	inch - 3,94	1,42	1,97	12 UN	lb 1,28			
QC FF SAE6 FEMALE	10	MPa 42	mm 31	76	- 30	9/16-	kg 0,29	NC06S02S000	QC FF SAE16 FEMALE	25	MPa 35	mm 54,5	100	- 50	1-5/16-	kg 1,25	NC06S05S000		
		Psi 6090	inch 1,22	2,99	- 1,18	18 UNF	lb 0,64				Psi 5075	inch 2,15	3,94	- 1,97	12 UN	lb 2,76			
QC FF SAE8 MALE	10	MPa 42	mm - 69,5	19,75	30	3/4-16	kg 0,13	NC05S02S001	QC FF SAE20 MALE	25	MPa 35	mm - 103	36	50	1-5/8-	kg 0,696	NC05S05S001		
		Psi 6090	inch - 2,74	0,78	1,18	UNF	lb 0,29				Psi 5075	inch - 4,06	1,42	1,97	12 UN	lb 1,53			
QC FF SAE8 FEMALE	10	MPa 42	mm 31	79	- 30	3/4-16	kg 0,25	NC06S02S001	QC FF SAE20 FEMALE	25	MPa 35	mm 54,5	103	- 50	1-5/8-	kg 1,323	NC06S05S001		
		Psi 6090	inch 1,22	3,11	- 1,18	UNF	lb 0,55				Psi 5075	inch 2,15	4,06	- 1,97	12 UN	lb 2,92			
QC FF SAE8 MALE	12.5	MPa 42	mm - 75	24,5	34	3/4-16	kg 0,317	NC05S03S000	QC FF SAE8 FEMALE	12.5	MPa 42	mm 38	81	- 34	3/4-16	kg 0,377	NC06S03S000		
		Psi 6090	inch - 2,95	0,96	1,34	UNF	lb 0,70				Psi 6090	inch 1,50	3,19	- 1,34	UNF	lb 0,83			
QC FF SAE12 MALE	12.5	MPa 42	mm - 80,5	24,5	34	1-1/16-	kg 0,291	NC05S03S001	QC FF SAE12 FEMALE	12.5	MPa 42	mm 38	86,5	- 34	1-1/16-	kg 0,411	NC06S03S001		
		Psi 6090	inch - 3,17	0,96	1,34	12 UN	lb 0,64				Psi 6090	inch 1,50	3,41	- 1,34	12 UN	lb 0,91			
QC FF SAE8 MALE	16	MPa 35	mm - 80	27	41	3/4-16	kg 0,4	NC05SA3S000	QC FF SAE8 FEMALE	16	MPa 35	mm 42	87	- 41	3/4-16	kg 0,52	NC06SA3S000		
		Psi 5075	inch - 3,15	1,06	1,61	UNF	lb 0,88				Psi 5075	inch 1,65	3,43	- 1,61	UNF	lb 1,15			
QC FF SAE12 MALE	16	MPa 35	mm - 85	27	41	1-1/16-	kg 0,3	NC05SA3S001	QC FF SAE12 FEMALE	16	MPa 35	mm 42	93	- 41	1-1/16-	kg 0,47	NC06SA3S001		
		Psi 5075	inch - 3,35	1,06	1,61	12 UN	lb 0,66				Psi 5075	inch 1,65	3,66	- 1,61	12 UN	lb 1,04			

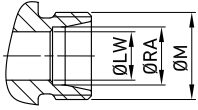
**QUICK COUPLINGS ISO 16028 FLAT FACE (male / female)
MALE THREAD METRIC ISO 8434-1-S (DIN 2353)**
CS

Carbon Steel

TYPE	DN	PN	ØA	C	Ød	ch	ØM	ØLW	ØRA	WEIGHT	ITEM CODE
QC FF 8S MALE	6,3	MPa 42	mm -	54,5	16,15	24	M16X1,5	5	8	kg 0,232	NC05H010000
		Psi 6090	inch -	2,15	0,64	0,94		0,20	0,31	lb 0,51	
QC FF 8S FEMALE	6,3	MPa 42	mm 27	68	-	24	M16X1,5	5	8	kg 0,338	NC06H010000
		Psi 6090	inch 1,06	2,68	-	0,94		0,20	0,31	lb 0,75	
QC FF 12S MALE	10	MPa 42	mm -	72	19,75	30	M20X1,5	8	12	kg 0,208	NC05H020000
		Psi 6090	inch -	2,83	0,78	1,18		0,31	0,47	lb 0,46	
QC FF 12S FEMALE	10	MPa 42	mm 31	81,5	-	30	M20X1,5	8	12	kg 0,695	NC06H020000
		Psi 6090	inch 1,22	3,21	-	1,18		0,31	0,47	lb 1,53	
QC FF 16S MALE	16	MPa 35	mm -	84	27	41	M24X1,5	12	16	kg 0,397	NC05HA30000
		Psi 5075	inch -	3,31	1,06	1,61		0,47	0,63	lb 0,88	
QC FF 16S FEMALE	16	MPa 35	mm 42	92	-	41	M24X1,5	12	16	kg 0,72	NC06HA30000
		Psi 5075	inch 1,65	3,62	-	1,61		0,47	0,63	lb 1,59	
QC FF 25S MALE	25	MPa 35	mm -	105	36	50	M36X2	20	25	kg 0,81	NC05H050000
		Psi 5075	inch -	4,13	1,42	1,97		0,79	0,98	lb 1,79	
QC FF 25S FEMALE	25	MPa 35	mm 54,5	105	-	50	M36X2	20	25	kg 1,16	NC06H050000
		Psi 5075	inch 2,15	4,13	-	1,97		0,79	0,98	lb 2,56	

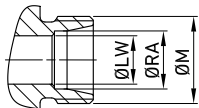

QUICK COUPLINGS ISO 16028 FLAT FACE (male / female) MALE THREAD METRIC ISO 8434-1-S (DIN 2353)

SS

Stainless Steel

TYPE	DN	PN	ØA	C	Ød	ch	ØM	ØLW	ØRA	WEIGHT	ITEM CODE
QC FF 8S MALE	6,3	MPa 42	mm	54,5	16,15	24	M16X1,5	5	8	kg 0,232	NC05H01S000
		Psi 6090	inch	0,00	2,15	0,64		0,94	0,20	0,31	
QC FF 8S FEMALE	6,3	MPa 42	mm	27	68	24	M16X1,5	5	8	kg 0,338	NC06H01S000
		Psi 6090	inch	1,06	2,68	0,00		0,94	0,20	0,31	
QC FF 12S MALE	10	MPa 42	mm	72	19,75	30	M20X1,5	8	12	kg 0,208	NC05H02S000
		Psi 6090	inch	0,00	2,83	0,78		1,18	0,31	0,47	
QC FF 12S FEMALE	10	MPa 42	mm	31	81,5	30	M20X1,5	8	12	kg 0,695	NC06H02S000
		Psi 6090	inch	1,22	3,21	0,00		1,18	0,31	0,47	
QC FF 16S MALE	16	MPa 35	mm	84	27	41	M24X1,5	12	16	kg 0,397	NC05HA3S000
		Psi 5075	inch	0,00	3,31	1,06		1,61	0,47	0,63	
QC FF 16S FEMALE	16	MPa 35	mm	42	92	41	M24X1,5	12	16	kg 0,72	NC06HA3S000
		Psi 5075	inch	1,65	3,62	0,00		1,61	0,47	0,63	
QC FF 25S MALE	25	MPa 35	mm	105	36	50	M36X2	20	25	kg 0,81	NC05H05S000
		Psi 5075	inch	0,00	4,13	1,42		1,97	0,79	0,98	
QC FF 25S FEMALE	25	MPa 35	mm	54,5	105	50	M36X2	20	25	kg 1,16	NC06H05S000
		Psi 5075	inch	2,15	4,13	0,00		1,97	0,79	0,98	

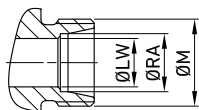
**QUICK COUPLINGS ISO 16028 FLAT FACE (male / female)
MALE THREAD METRIC ISO 8434-1-L (DIN 2353)**

TYPE	DN	PN	ØA	C	Ød	ch	ØM	ØLW	ØRA	WEIGHT	ITEM CODE	
QC FF 8L MALE	6.3	MPa 42	mm -	52,5	16,15	24	M14x1,5	6	8	kg 0,153	NC05L010000	
		Psi 6090	inch -	2,07	0,64	0,94		0,24	0,31	lb 0,34		
QC FF 8L FEMALE			MPa 42	mm 27	66	-	24	M14x1,5	6	8	kg 0,246	NC06L010000
		Psi 6090	inch 1,06	2,60	-	0,94	0,24		0,31	lb 0,54		
QC FF 10L MALE	6.3	MPa 42	mm -	53,5	16,15	24	M16x1,5	8	10	kg 0,154	NC05L010001	
		Psi 6090	inch -	2,11	0,64	0,94		0,31	0,39	lb 0,34		
QC FF 10L FEMALE			MPa 42	mm 27	67	-	24	M16x1,5	8	10	kg 0,227	NC06L010001
		Psi 6090	inch 1,06	2,64	-	0,94	0,31		0,39	lb 0,50		
QC FF 10L MALE	10	MPa 42	mm -	71	19,75	30	M16x1,5	8	10	kg 0,18	NC05L020001	
		Psi 6090	inch -	2,80	0,78	1,18		0,31	0,39	lb 0,40		
QC FF 10L FEMALE			MPa 42	mm 31	80,5	-	30	M16x1,5	8	10	kg 0,473	NC06L020001
		Psi 6090	inch 1,22	3,17	-	1,18	0,31		0,39	lb 1,04		
QC FF 12L MALE	10	MPa 42	mm -	71	19,75	30	M18X1,5	10	12	kg 0,18	NC05L020002	
		Psi 6090	inch -	2,80	0,78	1,18		0,39	0,47	lb 0,40		
QC FF 12L FEMALE			MPa 42	mm 31	80,5	-	30	M18X1,5	10	12	kg 0,469	NC06L020002
		Psi 6090	inch 1,22	3,17	-	1,18	0,39		0,47	lb 1,03		
QC FF 15L MALE	12.5	MPa 42	mm -	72	19,75	30	M22X1,5	12	15	kg 0,184	NC05L020003	
		Psi 6090	inch -	2,84	0,78	1,18		0,47	0,59	lb 0,41		
QC FF 15L FEMALE			MPa 42	mm 31	81,5	-	30	M22X1,5	12	15	kg 0,477	NC06L020003
		Psi 6090	inch 1,22	3,21	-	1,18	0,47		0,59	lb 1,05		
QC FF 12L MALE	12.5	MPa 42	mm -	74	24,5	34	M18X1,5	10	12	kg 0,376	NC05L030000	
		Psi 6090	inch -	2,91	0,96	1,34		0,39	0,47	lb 0,83		
QC FF 12L FEMALE			MPa 42	mm 38	80	-	34	M18X1,5	10	12	kg 0,658	NC06L030000
		Psi 6090	inch 1,50	3,15	-	1,34	0,39		0,47	lb 1,45		
QC FF 15L MALE	12.5	MPa 42	mm -	75	24,5	34	M22X1,5	12	15	kg 0,384	NC05L030001	
		Psi 6090	inch -	2,95	0,96	1,34		0,47	0,59	lb 0,85		
QC FF 15L FEMALE			MPa 42	mm 38	81	-	34	M22X1,5	12	15	kg 0,665	NC06L030001
		Psi 6090	inch 1,50	3,19	-	1,34	0,47		0,59	lb 1,47		
QC FF 18L MALE	16	MPa 42	mm -	75	24,5	34	M26X1,5	15	18	kg 0,396	NC05L030002	
		Psi 6090	inch -	2,95	0,96	1,34		0,59	0,71	lb 0,87		
QC FF 18L FEMALE			MPa 42	mm 38	81	-	34	M26X1,5	15	18	kg 0,673	NC06L030002
		Psi 6090	inch 1,50	3,19	-	1,34	0,59		0,71	lb 1,48		
QC FF 18L MALE	16	MPa 35	mm -	82	27	41	M26X1,5	15	18	kg 0,342	NC05LA30000	
		Psi 5075	inch -	3,23	1,06	1,61		0,59	0,71	lb 0,75		
QC FF 18L FEMALE			MPa 35	mm 42	90	-	41	M26X1,5	15	18	kg 0,649	NC06LA30000
		Psi 5075	inch 1,65	3,54	-	1,61	0,59		0,71	lb 1,43		
QC FF 22L MALE	16	MPa 35	mm -	84	27	41	M30X2	19	22	kg 0,339	NC05LA30001	
		Psi 5075	inch -	3,31	1,06	1,61		0,75	0,87	lb 0,75		
QC FF 22L FEMALE			MPa 35	mm 42	92	-	41	M30X2	19	22	kg 0,636	NC06LA30001
		Psi 5075	inch 1,65	3,62	-	1,61	0,75		0,87	lb 1,40		
QC FF 18L MALE	19	MPa 35	mm -	87	29,95	41	M26X1,5	15	18	kg 0,474	NC05L040000	
		Psi 5075	inch -	3,43	1,18	1,61		0,59	0,71	lb 1,04		
QC FF 18L FEMALE			MPa 35	mm 44	98	-	41	M26X1,5	15	18	kg 0,89	NC06L040000
		Psi 5075	inch 1,73	3,86	-	1,61	0,59		0,71	lb 1,96		
QC FF 22L MALE	19	MPa 35	mm -	89	29,95	41	M30X2	19	22	kg 0,461	NC05L040001	
		Psi 5075	inch -	3,50	1,18	1,61		0,75	0,87	lb 1,02		
QC FF 22L FEMALE			MPa 35	mm 44	100	-	41	M30X2	19	22	kg 0,882	NC06L040001
		Psi 5075	inch 1,73	3,94	-	1,61	0,75		0,87	lb 1,94		

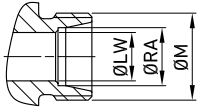

QUICK COUPLINGS ISO 16028 FLAT FACE (male / female) MALE THREAD METRIC ISO 8434-1-L (DIN 2353)

SS
Stainless Steel

TYPE	DN	PN	ØA	C	Ød	ch	ØM	ØLW	ØRA	WEIGHT	ITEM CODE		
QC FF 8L MALE	6.3	MPa 42	mm -	52,5	16,15	24	M14x1,5	6	8	kg 0,153	NC05L01S000		
		Psi 6090	inch -	2,07	0,64	0,94		0,24	0,31	lb 0,34			
QC FF 8L FEMALE			MPa 42	mm 27	66	-	24	M14x1,5	6	8	kg 0,246	NC06L01S000	
		Psi 6090	inch 1,06	2,60	-	0,94	0,24		0,31	lb 0,54			
QC FF 10L MALE			MPa 42	mm -	53,5	16,15	24	M16x1,5	8	10	kg 0,154	NC05L01S001	
		Psi 6090	inch -	2,11	0,64	0,94	0,31		0,39	lb 0,34			
QC FF 10L FEMALE		MPa 42	mm 27	67	-	24	M16x1,5	8	10	kg 0,227	NC06L01S001		
	Psi 6090	inch 1,06	2,64	-	0,94	0,31		0,39	lb 0,50				
QC FF 10L MALE	10	MPa 42	mm -	71	19,75	30	M16x1,5	8	10	kg 0,18	NC05L02S001		
		Psi 6090	inch -	2,80	0,78	1,18		0,31	0,39	lb 0,40			
QC FF 10L FEMALE			MPa 42	mm 31	80,5	-	30	M16x1,5	8	10	kg 0,473	NC06L02S001	
		Psi 6090	inch 1,22	3,17	-	1,18	0,31		0,39	lb 1,04			
QC FF 12L MALE			MPa 42	mm -	71	19,75	30	M18X1,5	10	12	kg 0,18	NC05L02S002	
		Psi 6090	inch -	2,80	0,78	1,18	0,39		0,47	lb 0,40			
QC FF 12L FEMALE			MPa 42	mm 31	80,5	-	30	M18X1,5	10	12	kg 0,469	NC06L02S002	
		Psi 6090	inch 1,22	3,17	-	1,18	0,39		0,47	lb 1,03			
QC FF 15L MALE		12.5	MPa 42	mm -	72	19,75	30	M22X1,5	12	15	kg 0,184	NC05L02S003	
			Psi 6090	inch -	2,84	0,78	1,18		0,47	0,59	lb 0,41		
QC FF 15L FEMALE				MPa 42	mm 31	81,5	-	30	M22X1,5	12	15	kg 0,477	NC06L02S003
			Psi 6090	inch 1,22	3,21	-	1,18	0,47		0,59	lb 1,05		
QC FF 12L MALE	12.5		MPa 42	mm -	74	24,5	34	M18X1,5	10	12	kg 0,376	NC05L03S000	
			Psi 6090	inch -	2,91	0,96	1,34		0,39	0,47	lb 0,83		
QC FF 12L FEMALE				MPa 42	mm 38	80	-	34	M18X1,5	10	12	kg 0,658	NC06L03S000
			Psi 6090	inch 1,50	3,15	-	1,34	0,39		0,47	lb 1,45		
QC FF 15L MALE				MPa 42	mm -	75	24,5	34	M22X1,5	12	15	kg 0,384	NC05L03S001
			Psi 6090	inch -	2,95	0,96	1,34	0,47		0,59	lb 0,85		
QC FF 15L FEMALE				MPa 42	mm 38	81	-	34	M22X1,5	12	15	kg 0,665	NC06L03S001
			Psi 6090	inch 1,50	3,19	-	1,34	0,47		0,59	lb 1,47		
QC FF 18L MALE		16	MPa 42	mm -	75	24,5	34	M26X1,5	15	18	kg 0,396	NC05L03S002	
			Psi 6090	inch -	2,95	0,96	1,34		0,59	0,71	lb 0,87		
QC FF 18L FEMALE				MPa 42	mm 38	81	-	34	M26X1,5	15	18	kg 0,673	NC06L03S002
			Psi 6090	inch 1,50	3,19	-	1,34	0,59		0,71	lb 1,48		
QC FF 18L MALE			MPa 35	mm -	82	27	41	M26X1,5	15	18	kg 0,342	NC05LA3S000	
	Psi 5075		inch -	3,23	1,06	1,61	0,59		0,71	lb 0,75			
QC FF 18L FEMALE			MPa 35	mm 42	90	-	41	M26X1,5	15	18	kg 0,649	NC06LA3S000	
	Psi 5075		inch 1,65	3,54	-	1,61	0,59		0,71	lb 1,43			
QC FF 22L MALE	19		MPa 35	mm -	84	27	41	M30X2	19	22	kg 0,339	NC05LA3S001	
			Psi 5075	inch -	3,31	1,06	1,61		0,75	0,87	lb 0,75		
QC FF 22L FEMALE				MPa 35	mm 42	92	-	41	M30X2	19	22	kg 0,636	NC06LA3S001
			Psi 5075	inch 1,65	3,62	-	1,61	0,75		0,87	lb 1,40		
QC FF 18L MALE		19	MPa 35	mm -	87	29,95	41	M26X1,5	15	18	kg 0,474	NC05L04S000	
			Psi 5075	inch -	3,43	1,18	1,61		0,59	0,71	lb 1,04		
QC FF 18L FEMALE			MPa 35	mm 44	98	-	41	M26X1,5	15	18	kg 0,89	NC06L04S000	
	Psi 5075		inch 1,73	3,86	-	1,61	0,59		0,71	lb 1,96			
QC FF 22L MALE			MPa 35	mm -	89	29,95	41	M30X2	19	22	kg 0,461	NC05L04S001	
	Psi 5075		inch -	3,50	1,18	1,61	0,75		0,87	lb 1,02			
QC FF 22L FEMALE		MPa 35	mm 44	100	-	41	M30X2	19	22	kg 0,882	NC06L04S001		
	Psi 5075	inch 1,73	3,94	-	1,61	0,75		0,87	lb 1,94				

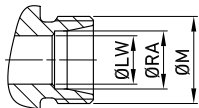
**QUICK COUPLINGS ISO 16028 FLAT FACE (male / female)
MALE THREAD METRIC ISO 8434-1-S (DIN 2353) BULKHEAD**
CS

Carbon Steel

TYPE	DN	PN	ØA	C	Ød	ch	ØM	ØLW	ØRA	WEIGHT	ITEM CODE
QC FF 8S BK MALE	6,3	MPa 42	mm -	69,5	16,15	24	M16X1,5	5	8	kg 0,254	NC05I010000
		Psi 6090	inch -	2,74	0,64	0,94		0,20	0,31	lb 0,56	
QC FF 8S BK FEMALE	6,3	MPa 42	mm 27	83	-	24	M16X1,5	5	8	kg 0,359	NC06I010000
		Psi 6090	inch 1,06	3,27	-	0,94		0,20	0,31	lb 0,79	
QC FF 12S BK MALE	10	MPa 42	mm -	87	19,75	30	M20X1,5	8	12	kg 0,24	NC05I020000
		Psi 6090	inch -	3,43	0,78	1,18		0,31	0,47	lb 0,53	
QC FF 12S BK FEMALE	10	MPa 42	mm 31	96,5	-	30	M20X1,5	8	12	kg 0,726	NC06I020000
		Psi 6090	inch 1,22	3,80	-	1,18		0,31	0,47	lb 1,60	
QC FF 16S BK MALE	12,5	MPa 42	mm -	92	24,5	34	M24X1,5	12	16	kg 0,546	NC05I030000
		Psi 6090	inch -	3,62	0,96	1,34		0,47	0,63	lb 1,20	
QC FF 16S BK FEMALE	12,5	MPa 42	mm 38	98	-	34	M24X1,5	12	16	kg 0,95	NC06I030000
		Psi 6090	inch 1,50	3,86	-	1,34		0,47	0,63	lb 2,09	
QC FF 16S BK MALE	16	MPa 35	mm -	99	27	41	M24X1,5	12	16	kg 0,437	NC05IA30000
		Psi 5075	inch -	3,90	1,06	1,61		0,47	0,63	lb 0,96	
QC FF 16S BK FEMALE	16	MPa 35	mm 42	107	-	41	M24X1,5	12	16	kg 0,76	NC06IA30000
		Psi 5075	inch 1,65	4,21	-	1,61		0,47	0,63	lb 1,68	
QC FF 20S BK MALE	19	MPa 35	mm -	113	29,95	41	M30X2	16	20	kg 0,546	NC05I040000
		Psi 5075	inch -	4,45	1,18	1,61		0,63	0,79	lb 1,20	
QC FF 20S BK FEMALE	19	MPa 35	mm 44	124	-	41	M30X2	16	20	kg 0,957	NC06I040000
		Psi 5075	inch 1,73	4,88	-	1,61		0,63	0,79	lb 2,11	
QC FF 25S BK MALE	19	MPa 35	mm -	117	29,95	41	M36X2	20	25	kg 0,615	NC05I040001
		Psi 5075	inch -	4,61	1,18	1,61		0,79	0,98	lb 1,36	
QC FF 25S BK FEMALE	19	MPa 35	mm 44	128	-	41	M36X2	20	25	kg 1,027	NC06I040001
		Psi 5075	inch 1,73	5,04	-	1,61		0,79	0,98	lb 2,26	
QC FFE 25S BK MALE	25	MPa 35	mm -	128	36	50	M36X2	20	25	kg 0,937	NC05I050000
		Psi 5075	inch -	5,04	1,42	1,97		0,79	0,98	lb 2,07	
QC FF 25S BK FEMALE	25	MPa 35	mm 54,5	128	-	50	M36X2	20	25	kg 1,28	NC06I050000
		Psi 5075	inch 2,15	5,04	-	1,97		0,79	0,98	lb 2,82	

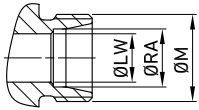

QUICK COUPLINGS ISO 16028 FLAT FACE (male / female) MALE THREAD METRIC ISO 8434-1-S (DIN 2353) BULKHEAD

SS
Stainless Steel

TYPE	DN	PN	ØA	C	Ød	ch	ØM	ØLW	ØRA	WEIGHT	ITEM CODE
QC FF 8S BK MALE	6,3	MPa 42	mm -	69,5	16,15	24	M16X1,5	5	8	kg 0,254	NC05I01S000
		Psi 6090	inch -	2,74	0,64	0,94		0,20	0,31	lb 0,56	
QC FF 8S BK FEMALE	6,3	MPa 42	mm 27	83	-	24	M16X1,5	5	8	kg 0,359	NC06I01S000
		Psi 6090	inch 1,06	3,27	-	0,94		0,20	0,31	lb 0,79	
QC FF 12S BK MALE	10	MPa 42	mm -	87	19,75	30	M20X1,5	8	12	kg 0,24	NC05I02S000
		Psi 6090	inch -	3,43	0,78	1,18		0,31	0,47	lb 0,53	
QC FF 12S BK FEMALE	10	MPa 42	mm 31	96,5	-	30	M20X1,5	8	12	kg 0,726	NC06I02S000
		Psi 6090	inch 1,22	3,80	-	1,18		0,31	0,47	lb 1,60	
QC FF 16S BK MALE	12,5	MPa 42	mm -	92	24,5	34	M24X1,5	12	16	kg 0,546	NC05I03S000
		Psi 6090	inch -	3,62	0,96	1,34		0,47	0,63	lb 1,20	
QC FF 16S BK FEMALE	12,5	MPa 42	mm 38	98	-	34	M24X1,5	12	16	kg 0,95	NC06I03S000
		Psi 6090	inch 1,50	3,86	-	1,34		0,47	0,63	lb 2,09	
QC FF 16S BK MALE	16	MPa 35	mm -	99	27	41	M24X1,5	12	16	kg 0,437	NC05IA3S000
		Psi 5075	inch -	3,90	1,06	1,61		0,47	0,63	lb 0,96	
QC FF 16S BK FEMALE	16	MPa 35	mm 42	107	-	41	M24X1,5	12	16	kg 0,76	NC06IA3S000
		Psi 5075	inch 1,65	4,21	-	1,61		0,47	0,63	lb 1,68	
QC FF 20S BK MALE	19	MPa 35	mm -	113	29,95	41	M30X2	16	20	kg 0,546	NC05I04S000
		Psi 5075	inch -	4,45	1,18	1,61		0,63	0,79	lb 1,20	
QC FF 20S BK FEMALE	19	MPa 35	mm 44	124	-	41	M30X2	16	20	kg 0,957	NC06I04S000
		Psi 5075	inch 1,73	4,88	-	1,61		0,63	0,79	lb 2,11	
QC FF 25S BK MALE	19	MPa 35	mm -	117	29,95	41	M36X2	20	25	kg 0,615	NC05I04S001
		Psi 5075	inch -	4,61	1,18	1,61		0,79	0,98	lb 1,36	
QC FF 25S BK FEMALE	19	MPa 35	mm 44	128	-	41	M36X2	20	25	kg 1,027	NC06I04S001
		Psi 5075	inch 1,73	5,04	-	1,61		0,79	0,98	lb 2,26	
QC FFE 25S BK MALE	25	MPa 35	mm -	128	36	50	M36X2	20	25	kg 0,937	NC05I05S000
		Psi 5075	inch -	5,04	1,42	1,97		0,79	0,98	lb 2,07	
QC FF 25S BK FEMALE	25	MPa 35	mm 54,5	128	-	50	M36X2	20	25	kg 1,28	NC06I05S000
		Psi 5075	inch 2,15	5,04	-	1,97		0,79	0,98	lb 2,82	

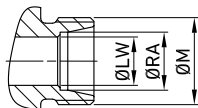

**QUICK COUPLINGS ISO 16028 FLAT FACE (male / female)
 MALE THREAD METRIC ISO 8434-1-L (DIN 2353) BULKHEAD**
CS

Carbon Steel

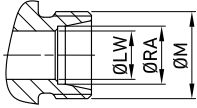
TYPE	DN	PN	ØA	C	Ød	ch	ØM	ØLW	ØRA	WEIGHT	ITEM CODE
QC FF 8L BK MALE	6,3	MPa 42	mm -	67,5	16,15	24	M14x1,5	6	8	kg 0,17	NC05M010000
		Psi 6090	inch -	2,66	0,64	0,94		0,24	0,31	lb 0,37	
QC FF 8L BK FEMALE	6,3	MPa 42	mm 27	81	-	24	M14x1,5	6	8	kg 0,258	NC06M010000
		Psi 6090	inch 1,06	3,19	-	0,94		0,24	0,31	lb 0,57	
QC FF 10L BK MALE	6,3	MPa 42	mm -	68,5	16,15	24	M16x1,5	8	10	kg 0,173	NC05M010001
		Psi 6090	inch -	2,70	0,64	0,94		0,31	0,39	lb 0,38	
QC FF 10L BK FEMALE	6,3	MPa 42	mm 27	82	-	24	M16x1,5	8	10	kg 0,261	NC06M010001
		Psi 6090	inch 1,06	3,23	-	0,94		0,31	0,39	lb 0,58	
QC FF 10L BK MALE	10	MPa 42	mm -	86	19,75	30	M16x1,5	8	10	kg 0,194	NC05M020000
		Psi 6090	inch -	3,39	0,78	1,18		0,31	0,39	lb 0,43	
QC FF 10L BK FEMALE	10	MPa 42	mm 31	95,5	-	30	M16x1,5	8	10	kg 0,492	NC06M020000
		Psi 6090	inch 1,22	3,76	-	1,18		0,31	0,39	lb 1,08	
QC FF 12L BK MALE	10	MPa 42	mm -	87	19,75	30	M18x1,5	10	12	kg 0,196	NC05M020001
		Psi 6090	inch -	3,43	0,78	1,18		0,39	0,47	lb 0,43	
QC FF 12L BK FEMALE	10	MPa 42	mm 31	96,5	-	30	M18x1,5	10	12	kg 0,49	NC06M020001
		Psi 6090	inch 1,22	3,80	-	1,18		0,39	0,47	lb 1,08	
QC FF 15L BK MALE	12,5	MPa 42	mm -	87	19,75	30	M22x1,5	12	15	kg 0,214	NC05M020002
		Psi 6090	inch -	3,43	0,78	1,18		0,47	0,59	lb 0,47	
QC FF 15L BK FEMALE	12,5	MPa 42	mm 31	96,5	-	30	M22x1,5	12	15	kg 0,503	NC06M020002
		Psi 6090	inch 1,22	3,80	-	1,18		0,47	0,59	lb 1,11	
QC FF 12L BK MALE	12,5	MPa 42	mm -	90	24,5	34	M18x1,5	10	12	kg 0,397	NC05M030000
		Psi 6090	inch -	3,54	0,96	1,34		0,39	0,47	lb 0,88	
QC FF 12L BK FEMALE	12,5	MPa 42	mm 38	96	-	34	M18x1,5	10	12	kg 0,679	NC06M030000
		Psi 6090	inch 1,50	3,78	-	1,34		0,39	0,47	lb 1,50	
QC FF 15L BK MALE	12,5	MPa 42	mm -	90	24,5	34	M22x1,5	12	15	kg 0,409	NC05M030001
		Psi 6090	inch -	3,54	0,96	1,34		0,47	0,59	lb 0,90	
QC FF 15L BK FEMALE	12,5	MPa 42	mm 38	96	-	34	M22x1,5	12	15	kg 0,691	NC06M030001
		Psi 6090	inch 1,50	3,78	-	1,34		0,47	0,59	lb 1,52	
QC FF 18L BK MALE	16	MPa 35	mm -	97	27	41	M26x1,5	15	18	kg 0,383	NC05MA30000
		Psi 5075	inch -	3,82	1,06	1,61		0,59	0,71	lb 0,84	
QC FF 18L BK FEMALE	16	MPa 35	mm 42	105	-	41	M26x1,5	15	18	kg 0,69	NC06MA30000
		Psi 5075	inch 1,65	4,13	-	1,61		0,59	0,71	lb 1,52	
QC FF 18L BK MALE	19	MPa 35	mm -	102	29,95	41	M26x1,5	15	18	kg 0,509	NC05M040000
		Psi 5075	inch -	4,02	1,18	1,61		0,59	0,71	lb 1,12	
QC FF 18L BK FEMALE	19	MPa 35	mm 44	113	-	41	M26x1,5	15	18	kg 0,935	NC06M040000
		Psi 5075	inch 1,73	4,45	-	1,61		0,59	0,71	lb 2,06	
QC FF 22L BK MALE	19	MPa 35	mm -	109	29,95	41	M30x2	19	22	kg 0,529	NC05M040001
		Psi 5075	inch -	4,29	1,18	1,61		0,75	0,87	lb 1,17	
QC FF 22L BK FEMALE	19	MPa 35	mm 44	120	-	41	M30x2	19	22	kg 0,945	NC06M040001
		Psi 5075	inch 1,73	4,72	-	1,61		0,75	0,87	lb 2,08	

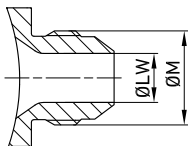

**QUICK COUPLINGS ISO 16028 FLAT FACE (male / female)
 MALE THREAD METRIC ISO 8434-1-L (DIN 2353) BULKHEAD**

TYPE	DN	PN	ØA	C	Ød	ch	ØM	ØLW	ØRA	WEIGHT	ITEM CODE
QC FF 8L BK MALE	6,3	MPa 42	mm -	67,5	16,15	24	M14x1,5	6	8	kg 0,17	NC05M01S000
		Psi 6090	inch -	2,66	0,64	0,94		0,24	0,31	lb 0,37	
QC FF 8L BK FEMALE	6,3	MPa 42	mm 27	81	-	24	M14x1,5	6	8	kg 0,258	NC06M01S000
		Psi 6090	inch 1,06	3,19	-	0,94		0,24	0,31	lb 0,57	
QC FF 10L BK MALE	6,3	MPa 42	mm -	68,5	16,15	24	M16x1,5	8	10	kg 0,173	NC05M01S001
		Psi 6090	inch -	2,70	0,64	0,94		0,31	0,39	lb 0,38	
QC FF 10L BK FEMALE	6,3	MPa 42	mm 27	82	-	24	M16x1,5	8	10	kg 0,261	NC06M01S001
		Psi 6090	inch 1,06	3,23	-	0,94		0,31	0,39	lb 0,58	
QC FF 10L BK MALE	10	MPa 42	mm -	86	19,75	30	M16x1,5	8	10	kg 0,194	NC05M02S000
		Psi 6090	inch -	3,39	0,78	1,18		0,31	0,39	lb 0,43	
QC FF 10L BK FEMALE	10	MPa 42	mm 31	95,5	-	30	M16x1,5	8	10	kg 0,492	NC06M02S000
		Psi 6090	inch 1,22	3,76	-	1,18		0,31	0,39	lb 1,08	
QC FF 12L BK MALE	10	MPa 42	mm -	87	19,75	30	M18X1,5	10	12	kg 0,196	NC05M02S001
		Psi 6090	inch -	3,43	0,78	1,18		0,39	0,47	lb 0,43	
QC FF 12L BK FEMALE	10	MPa 42	mm 31	96,5	-	30	M18X1,5	10	12	kg 0,49	NC06M02S001
		Psi 6090	inch 1,22	3,80	-	1,18		0,39	0,47	lb 1,08	
QC FF 15L BK MALE	12,5	MPa 42	mm -	87	19,75	30	M22X1,5	12	15	kg 0,214	NC05M02S002
		Psi 6090	inch -	3,43	0,78	1,18		0,47	0,59	lb 0,47	
QC FF 15L BK FEMALE	12,5	MPa 42	mm 31	96,5	-	30	M22X1,5	12	15	kg 0,503	NC06M02S002
		Psi 6090	inch 1,22	3,80	-	1,18		0,47	0,59	lb 1,11	
QC FF 12L BK MALE	12,5	MPa 42	mm -	90	24,5	34	M18X1,5	10	12	kg 0,397	NC05M03S000
		Psi 6090	inch -	3,54	0,96	1,34		0,39	0,47	lb 0,88	
QC FF 12L BK FEMALE	12,5	MPa 42	mm 38	96	-	34	M18X1,5	10	12	kg 0,679	NC06M03S000
		Psi 6090	inch 1,50	3,78	-	1,34		0,39	0,47	lb 1,50	
QC FF 15L BK MALE	12,5	MPa 42	mm -	90	24,5	34	M22X1,5	12	15	kg 0,409	NC05M03S001
		Psi 6090	inch -	3,54	0,96	1,34		0,47	0,59	lb 0,90	
QC FF 15L BK FEMALE	12,5	MPa 42	mm 38	96	-	34	M22X1,5	12	15	kg 0,691	NC06M03S001
		Psi 6090	inch 1,50	3,78	-	1,34		0,47	0,59	lb 1,52	
QC FF 18L BK MALE	16	MPa 35	mm -	97	27	41	M26X1,5	15	18	kg 0,383	NC05MA3S000
		Psi 5075	inch -	3,82	1,06	1,61		0,59	0,71	lb 0,84	
QC FF 18L BK FEMALE	16	MPa 35	mm 42	105	-	41	M26X1,5	15	18	kg 0,69	NC06MA3S000
		Psi 5075	inch 1,65	4,13	-	1,61		0,59	0,71	lb 1,52	
QC FF 18L BK MALE	19	MPa 35	mm -	102	29,95	41	M26X1,5	15	18	kg 0,509	NC05M04S000
		Psi 5075	inch -	4,02	1,18	1,61		0,59	0,71	lb 1,12	
QC FF 18L BK FEMALE	19	MPa 35	mm 44	113	-	41	M26X1,5	15	18	kg 0,935	NC06M04S000
		Psi 5075	inch 1,73	4,45	-	1,61		0,59	0,71	lb 2,06	
QC FF 22L BK MALE	19	MPa 35	mm -	109	29,95	41	M30X2	19	22	kg 0,529	NC05M04S001
		Psi 5075	inch -	4,29	1,18	1,61		0,75	0,87	lb 1,17	
QC FF 22L BK FEMALE	19	MPa 35	mm 44	120	-	41	M30X2	19	22	kg 0,945	NC06M04S001
		Psi 5075	inch 1,73	4,72	-	1,61		0,75	0,87	lb 2,08	

**QUICK COUPLINGS ISO 16028 FLAT FACE (male / female)
MALE THREAD ISO 8434-2 (SAE J514) JIC**

CS
 Carbon Steel

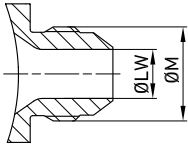
TYPE	DN	PN	ØA	C	Ød	ch	ØM	ØLW	WEIGHT	ITEM CODE
QC FF 3/8 JIC MALE	6,3	MPa 42	mm -	50	16,15	24	9/16-18 UNF	7,5	kg 0,153	NC05J010000
		Psi 6090	inch -	1,97	0,64	0,94		0,30	lb 0,34	
QC FF 3/8 JIC FEMALE		MPa 42	mm 27	63,6	-	24	9/16-18 UNF	7,5	kg 0,246	NC0JG010000
		Psi 6090	inch 1,06	2,50	-	0,94		0,30	lb 0,54	
QC FF 3/8 JIC MALE	10	MPa 42	mm -	68,2	19,75	30	9/16-18 UNF	7,5	kg 0,18	NC05J020000
		Psi 6090	inch -	2,69	0,78	1,18		0,30	lb 0,40	
QC FF 3/8 JIC FEMALE		MPa 42	mm 31	77,8	-	30	9/16-18 UNF	7,5	kg 0,473	NC06J020000
		Psi 6090	inch 1,22	3,06	-	1,18		0,30	lb 1,04	
QC FF 5/8 JIC MALE		MPa 42	mm -	73,4	19,75	30	7/8-14 UNF	12,3	kg 0,18	NC05J020001
		Psi 6090	inch -	2,89	0,78	1,18		0,48	lb 0,40	
QC FF 5/8 JIC FEMALE		MPa 42	mm 31	83	-	30	7/8-14 UNF	12,3	kg 0,469	NC06J020001
		Psi 6090	inch 1,22	3,27	-	1,18		0,48	lb 1,03	
QC FF 1/2 JIC MALE	MPa 42	mm -	70	19,75	30	3/4-16 UNF	9,9	kg 0,184	NC05J020002	
	Psi 6090	inch -	2,76	0,78	1,18		0,39	lb 0,41		
QC FF 1/2 JIC FEMALE	MPa 42	mm 31	80	-	30	3/4-16 UNF	9,9	kg 0,477	NC06J020002	
	Psi 6090	inch 1,22	3,15	-	1,18		0,39	lb 1,05		
QC FF 1/2 JIC MALE	12,5	MPa 42	mm -	76,2	24,5	34	3/4-16 UNF	9,9	kg 0,376	NC05J030000
		Psi 6090	inch -	3,00	0,96	1,34		0,39	lb 0,83	
QC FF 1/2 JIC FEMALE		MPa 42	mm 38	82,2	-	34	3/4-16 UNF	9,9	kg 0,658	NC06J030000
		Psi 6090	inch 1,50	3,24	-	1,34		0,39	lb 1,45	
QC FF 5/8 JIC MALE		MPa 42	mm -	79,3	24,5	34	7/8-14 UNF	12,3	kg 0,384	NC05J030001
		Psi 6090	inch -	3,12	0,96	1,34		0,48	lb 0,85	
QC FF 5/8 JIC FEMALE		MPa 42	mm 38	85,3	-	34	7/8-14 UNF	12,3	kg 0,665	NC06J030001
		Psi 6090	inch 1,50	3,36	-	1,34		0,48	lb 1,47	
QC FF 3/4 JIC MALE		MPa 42	mm -	81,9	24,5	34	1-1/16-12 UN	15,5	kg 0,396	NC05J030002
		Psi 6090	inch -	3,22	0,96	1,34		0,61	lb 0,87	
QC FF 3/4 JIC FEMALE		MPa 42	mm 38	87,9	-	34	1-1/16-12 UN	15,5	kg 0,673	NC06J030002
		Psi 6090	inch 1,50	3,46	-	1,34		0,61	lb 1,48	
QC FF 1 JIC MALE		MPa 42	mm -	83,1	24,5	34	1-5/16-12 UN	21,5	kg 0,34	NC05J030003
		Psi 6090	inch -	3,27	0,96	1,34		0,85	lb 0,75	
QC FF 1 JIC FEMALE		MPa 42	mm 38	89	-	34	1-5/16-12 UN	21,5	kg 0,66	NC06J030003
		Psi 6090	inch 1,50	3,50	-	1,34		0,85	lb 1,46	
"C FF 1 JIC MALE	16	MPa 35	mm -	84,3	27	41	1-5/16-12 UN	21,5	kg 0,342	NC05JA30000
		Psi 5075	inch -	3,32	1,06	1,61		0,85	lb 0,75	
"C FF 1 JIC FEMALE		MPa 35	mm 42	92	-	41	1-5/16-12 UN	21,5	kg 0,649	NC06JA30000
		Psi 5075	inch 1,65	3,62	-	1,61		0,85	lb 1,43	

**QUICK COUPLINGS ISO 16028 FLAT FACE (male / female)
MALE THREAD ISO 8434-2 (SAE J514) JIC**

SS

Stainless Steel

TYPE	DN	PN	ØA	C	Ød	ch	ØM	ØLW	WEIGHT	ITEM CODE
QC FF 3/8 JIC MALE	6,3	MPa 42	mm -	50	16,15	24	9/16-18 UNF	7,5	kg 0,153	NC05J01S000
		Psi 6090	inch -	1,97	0,64	0,94		0,30	lb 0,34	
QC FF 3/8 JIC FEMALE	6,3	MPa 42	mm 27	63,6	-	24	9/16-18 UNF	7,5	kg 0,246	NC0JG01S000
		Psi 6090	inch 1,06	2,50	-	0,94		0,30	lb 0,54	
QC FF 3/8 JIC MALE	10	MPa 42	mm -	73,4	19,75	30	9/16-18 UNF	7,5	kg 0,18	NC05J02S000
		Psi 6090	inch -	2,89	0,78	1,18		0,30	lb 0,40	
QC FF 3/8 JIC FEMALE	10	MPa 42	mm 31	83	-	30	9/16-18 UNF	7,5	kg 0,473	NC06J02S000
		Psi 6090	inch 1,22	3,27	-	1,18		0,30	lb 1,04	
QC FF 5/8 JIC MALE	10	MPa 42	mm -	68,2	19,75	30	7/8-14 UNF	12,3	kg 0,18	NC05J02S001
		Psi 6090	inch -	2,69	0,78	1,18		0,48	lb 0,40	
QC FF 5/8 JIC FEMALE	10	MPa 42	mm 31	77,8	-	30	7/8-14 UNF	12,3	kg 0,469	NC06J02S001
		Psi 6090	inch 1,22	3,06	-	1,18		0,48	lb 1,03	
QC FF 1/2 JIC MALE	12,5	MPa 42	mm -	70	19,75	30	3/4-16 UNF	9,9	kg 0,184	NC05J02S002
		Psi 6090	inch -	2,76	0,78	1,18		0,39	lb 0,41	
QC FF 1/2 JIC FEMALE	12,5	MPa 42	mm 31	80	-	30	3/4-16 UNF	9,9	kg 0,477	NC06J02S002
		Psi 6090	inch 1,22	3,15	-	1,18		0,39	lb 1,05	
QC FF 1/2 JIC MALE	12,5	MPa 42	mm -	76,2	24,5	34	3/4-16 UNF	9,9	kg 0,376	NC05J03S000
		Psi 6090	inch -	3,00	0,96	1,34		0,39	lb 0,83	
QC FF 1/2 JIC FEMALE	12,5	MPa 42	mm 38	82,2	-	34	3/4-16 UNF	9,9	kg 0,658	NC06J03S000
		Psi 6090	inch 1,50	3,24	-	1,34		0,39	lb 1,45	
QC FF 5/8 JIC MALE	12,5	MPa 42	mm -	79,3	24,5	34	7/8-14 UNF	12,3	kg 0,384	NC05J03S001
		Psi 6090	inch -	3,12	0,96	1,34		0,48	lb 0,85	
QC FF 5/8 JIC FEMALE	12,5	MPa 42	mm 38	85,3	-	34	7/8-14 UNF	12,3	kg 0,665	NC06J03S001
		Psi 6090	inch 1,50	3,36	-	1,34		0,48	lb 1,47	
QC FF 3/4 JIC MALE	16	MPa 42	mm -	81,9	24,5	34	1-1/16-12 UN	15,5	kg 0,396	NC05J03S002
		Psi 6090	inch -	3,22	0,96	1,34		0,61	lb 0,87	
QC FF 3/4 JIC FEMALE	16	MPa 42	mm 38	87,9	-	34	1-1/16-12 UN	15,5	kg 0,673	NC06J03S002
		Psi 6090	inch 1,50	3,46	-	1,34		0,61	lb 1,48	
QC FF 1 JIC MALE	16	MPa 42	mm -	83,1	24,5	34	1-5/16-12 UN	21,5	kg 0,34	NC05J03S003
		Psi 6090	inch -	3,27	0,96	1,34		0,85	lb 0,75	
QC FF 1 JIC FEMALE	16	MPa 42	mm 38	89	-	34	1-5/16-12 UN	21,5	kg 0,66	NC06J03S003
		Psi 6090	inch 1,50	3,50	-	1,34		0,85	lb 1,46	
QC FF 1 JIC MALE	16	MPa 35	mm -	84,3	27	41	1-5/16-12 UN	21,5	kg 0,342	NC05JA3S000
		Psi 5075	inch -	3,32	1,06	1,61		0,85	lb 0,75	
QC FF 1 JIC FEMALE	16	MPa 35	mm 42	92	-	41	1-5/16-12 UN	21,5	kg 0,649	NC06JA3S000
		Psi 5075	inch 1,65	3,62	-	1,61		0,85	lb 1,43	