



FRT SERIES

Tank top return filters

Return filter for the tank lid mounting. Filter element with inbuilt bypass valve. Flow rates up to 900 l/min. Range of accessories available.



HOUSING

tested according to NFPA T3.10.5.1*, ISO 10771*, ISO 3968

PRESSURE: Max operating: 8 bar
Burst: 16 bar

CONNECTIONS: G 1/2" ÷ G 2"

MATERIALS: Cover and head: aluminium alloy
Bowl: PA6 reinforced
Seal: NBR (FKM on request)

BYPASS VALVE: Inbuilt in the filter element
B version 1,7 bar
C version 3 bar

ELEMENT

tested according to ISO 11170, 2941, 2942, 2943, 3724, 3968, 16889, 16908, 23181

FILTER MEDIA: Inorganic microfiber
G06 - G10 - G15 - G25 - G40
Paper: C10 - C25
Synthetic: M05 - M10 - M15
Metal wire mesh: T60

COLLAPSE PRESSURE: 10 bar

TEMPERATURE RANGE: -30°C +100°C

FLUID COMPATIBILITY: Full with HH-HL-HM-HV
HETG-HEES (acc. to ISO 6743/4).
For use with other fluid please contact Filtrec Customer Service (info@filtrec.it).

* as reference method only for verifying the pressure fatigue resistance and establishing the burst pressure ratings.

OVERALL DIMENSIONS

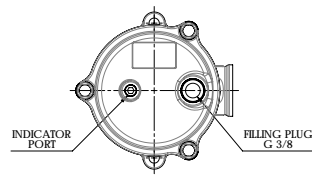
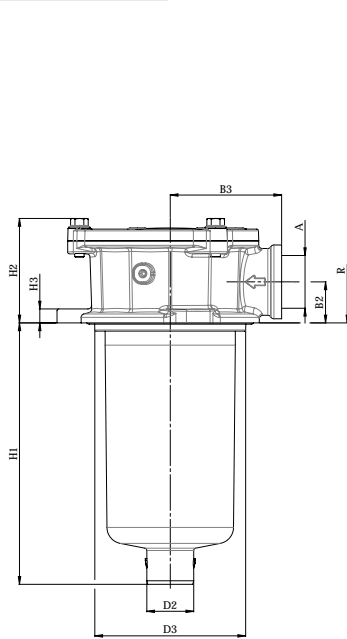

FRT 20 | 22 | 30 | 31

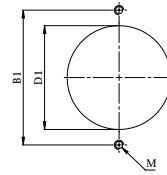

TANK MOUNTING PATTERN

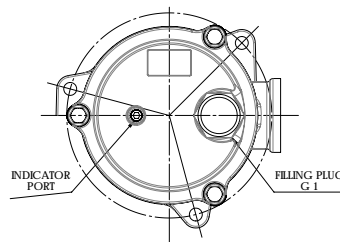

FRT 40 | 43 | 45

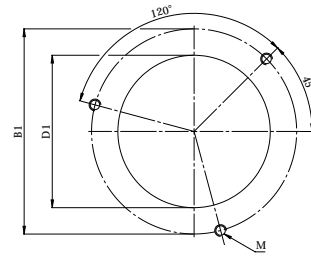

TANK MOUNTING PATTERN

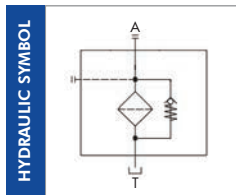

HYDRAULIC SYMBOL

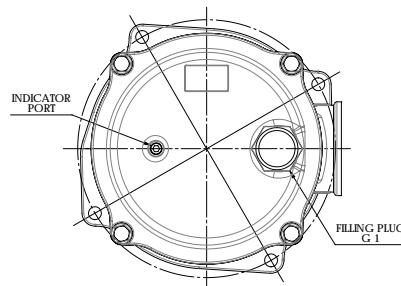

FRT 50 | 51 | 60 | 64 | 66

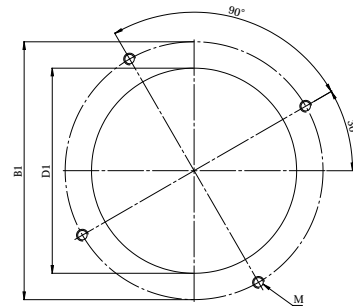

TANK MOUNTING PATTERN

NOMINAL SIZE

MODEL	A	Ø B1	B2	B3	Ø D1	Ø D2	Ø D3	H1	H2	H3	M	R	WEIGHT Kg	
FRT 20	G 1/2"							92					160	0,80
FRT 22	G 3/4"		28,5					137					210	0,90
FRT 30	G 1"	115		67	88,5		87	218	73		M8		290	1,10
FRT 31	G 1 1/4"		32				40	322					390	1,30
FRT 40	G 1" - G 1 1/4" G 1 1/2"	175	35	95	130		129	223	90	11			300	2,10
269								350					2,40	
436								520					3,10	
FRT 50								164					250	2,90
FRT 51	G 1 1/4"	220	42	115	175	65	174	223	105				310	3,30
FRT 60	G 1 1/2"							273					360	3,90
FRT 64	G 2"							423					510	5,10
FRT 66														

ORDERING INFORMATION

	1.	2.	3.	4.	5.	6.	7.	8.	9.	10.
	FRT	R1	30	G10	B	B	B6	0	C	000
SPARE ELEMENT		R1	30	G10	B					

1. FILTER SERIES	FRT	
2. FILTER ELEMENT SERIES	R1	
3. FILTER SIZE	20-22-30-31	
	40-43-45	
	50-51-60-64-66	
4. FILTER MEDIA	000	no element
	G06	glassfiber $\beta_{7\mu\text{m(c)}} > 1.000$
	G10	glassfiber $\beta_{12\mu\text{m(c)}} > 1.000$
	G15	glassfiber $\beta_{17\mu\text{m(c)}} > 1.000$
	G25	glassfiber $\beta_{22\mu\text{m(c)}} > 1.000$
	G40	glassfiber $\beta_{35\mu\text{m(c)}} > 1.000$
	C10	paper $\beta_{10\mu\text{m(c)}} > 2$
	C25	paper $\beta_{25\mu\text{m(c)}} > 2$
	T60	wire mesh 60 μm
	M05	synthetic $\beta_{10\mu\text{m(c)}} > 1.000$
	M10	synthetic $\beta_{15\mu\text{m(c)}} > 1.000$
	M15	synthetic $\beta_{20\mu\text{m(c)}} > 1.000$
5. BYPASS VALVE	B	1,7 bar (for paper and wire mesh elements)
	C	3 bar (for glassfiber elements)
6. SEALS	*B	NBR
* omitted for spare elements	V	FKM (on request)
7. CONNECTION PORT	B3	G 1/2" size 20 to 31
	B4	G 3/4" size 20 to 31
	B5	G 1" size 20 to 31
	B6	G 1 1/4" size 20 to 66
	B7	G 1 1/2" size 40 to 66
	B8	G 2" size 50 to 66
8. FILLING PLUG	0	no filling plug
	T	with filling plug

Continued on the next page

ORDERING INFORMATION

9. INDICATOR PORT	C	1/8" plugged
-------------------	---	--------------

10. CLOGGING INDICATORS	000	without indicator
	MPB	press. gauge rear connection
	MRB	press. gauge radial connection for "B" bypass
	PDB	pressure switch
	MPC	press. gauge rear connection
	MRC	press. gauge radial connection for "C" bypass
	PDC	pressure switch

ACCESSORIES

The accessories must be ordered separately

LC24	LED connector for pressure switch
ET2250	extension tube 250 mm long (for size 20 to 45)
ET2500	extension tube 500 mm long
ET4200	extension tube 200 mm long (for size 50 to 66)
ET4500	extension tube 500 mm long
CT2250	connection tube 250 mm long (for size 20 to 45)
CT4200	connection tube 200 mm long (for size 50 to 66)
DF040	diffuser Ø 40 mm (for size 20 to 45)
DF065	diffuser Ø 65 mm (for size 50 to 66)

PRESSURE DROP (Δp) INFORMATION FOR FILTER SIZING

The total Delta P through a filter assembly is given from Housing Δp + Element Δp .
The max recommended total Δp for return filters is 0,4 – 0,6 bar with clean element.

N.B. All the reported data have been obtained at our laboratory, according to specification ISO3968 with mineral oil having 32 cSt viscosity at 40°C and density 0,875 kg/dm³.

HOUSING PRESSURE DROP

The housing Δp is given by the curve of the considered model and port, in correspondence of the flow rate value.

FRT 20-22

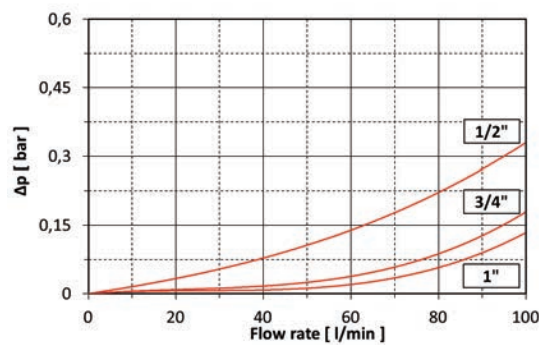

FRT 30-31

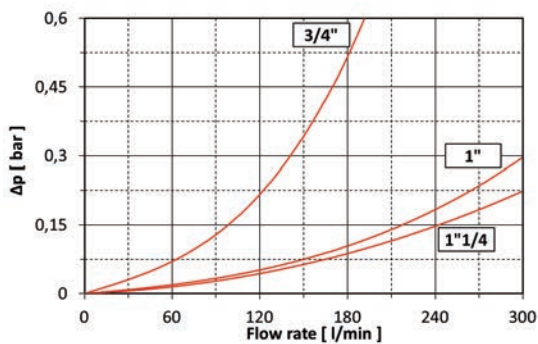

FRT 40-43-45

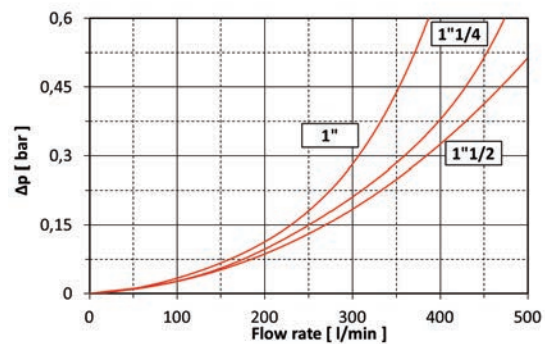

FRT 50-51

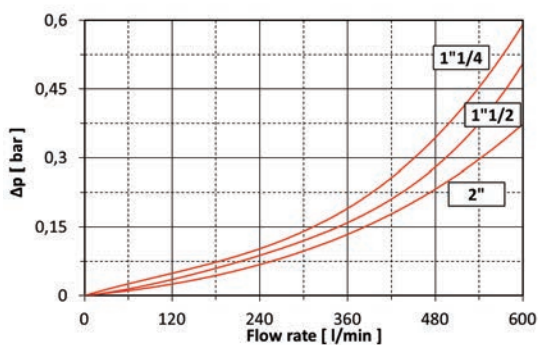

FRT 60-64-66

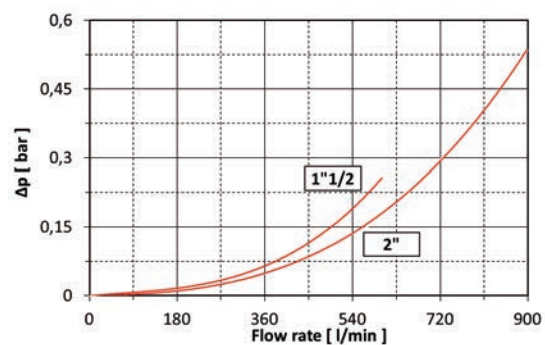

ELEMENT PRESSURE DROP

The element Δp (bar) is given by the flow rate (l/min) multiplied by the factor in the table here below corresponding to the selected media and divided by 1000.

If the oil has a viscosity V_1 different than 32 cSt a corrective factor $V_1/32$ must be applied.

Example: 80 l/min with R130G10B and oil viscosity 46 cSt $> 80 \times 3,19/1000 \times 46/32 = 0,36$ bar

	G06	G10	G15	G25	G40	C10	C25	T60	M05	M10	M15
R120	13,85	8,65	6,44	6,32	2,77	4,09	2,52	0,86	5,65	4,83	3,19
R122	7,80	5,27	3,92	3,60	1,55	2,70	1,41	0,76	3,83	3,27	1,79
R130	5,09	3,19	2,25	2,06	0,90	1,64	0,82	0,49	2,31	1,98	1,02
R131	3,34	1,94	1,37	1,26	0,46	1,06	0,42	0,24	1,41	1,20	0,63
R140	2,43	1,31	1,25	1,10	0,43	0,85	0,39	0,22	0,95	0,82	0,62
R143	2,25	1,21	1,15	1,00	0,39	0,83	0,35	0,20	0,88	0,75	0,57
R145	1,35	0,55	0,52	0,50	0,17	0,42	0,22	0,10	0,52	0,44	0,32
R150	2,16	1,12	1,08	0,96	0,37	0,82	0,34	0,19	0,81	0,69	0,54
R151	1,80	0,88	0,77	0,71	0,29	0,64	0,26	0,15	0,64	0,55	0,38
R160	1,49	0,74	0,71	0,51	0,25	0,45	0,23	0,10	0,54	0,46	0,35
R164	1,32	0,52	0,45	0,42	0,13	0,36	0,12	0,10	0,38	0,32	0,21
R166	0,80	0,43	0,34	0,24	0,11	0,20	0,10	0,06	0,22	0,20	0,18

EXAMPLE OF TOTAL Δp CALCULATION

FRTR130G10BBB60C000 with **80 l/min** and oil **46 cSt**:

Housing Δp 0,01 bar + element Δp 0,36 bar ($80 \times 3,19/1000 \times 46/32$) = total assembly Δp 0,37 bar

BYPASS VALVE PRESSURE DROP

The bypass valve Δp is given by the curve of the considered model and setting, in correspondence of the flow rate value.

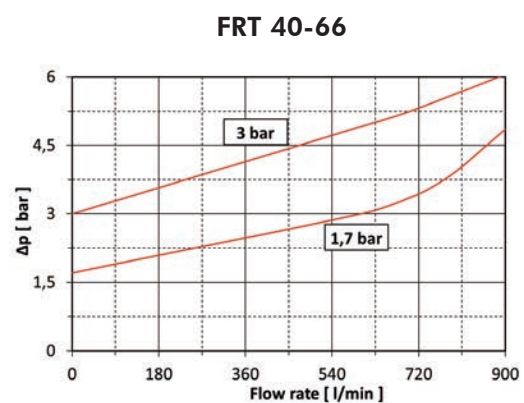
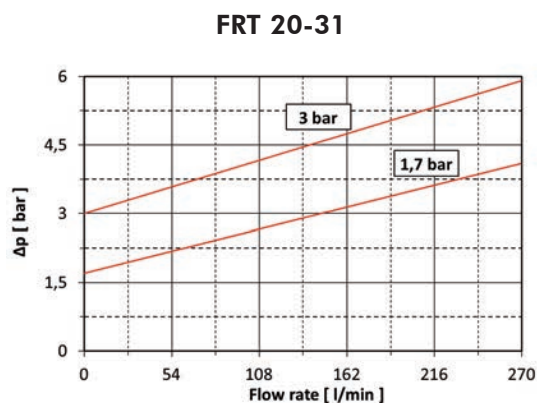

ACCESSORIES

These accessories fit all our standard models and must be ordered separately.



A EXTENSION TUBE

The flow from the filter must come out below the oil level to avoid possible generation of free air or foam. When necessary an extension tube can be fitted onto the knobs of the bowl end.

for size 20 to 45

ET2250	extension tube 250 mm long
ET2500	extension tube 500 mm long

for size 50 to 66

ET4200	extension tube 200 mm long
ET4500	extension tube 500 mm long

B CONNECTION TUBE

Connection tube is the necessary device between filter bowl and extension tubes (ET2250 / ET2500 / ET4200 / ET4500) and/or diffuser (DF040 / DF065). Its plug and play option makes it easy to install and versatile.

for size 20 to 45

CT2250	connection tube 250 mm long
--------	-----------------------------

for size 50 to 66

CT4200	connection tube 200 mm long
--------	-----------------------------

C DIFFUSER

Diffuser is an effective way to reduce foaming and turbulence normally caused by return lines. Plug and play option to be directly installed on the filter bowl or to connection tube (CT2250/CT4200). Installation of a diffuser in the hydraulic tank is an easy way to ensure the reliability of the overall system.

Diffuser must always be installed below the minimum oil level.

for size 20 to 45

DF040	diffuser Ø 40 mm
-------	------------------

for size 50 to 66

DF065	diffuser Ø 65 mm
-------	------------------

USER TIPS



- 1 FILTER HEAD
- 2 FILTER BOWL
- 3 FILTER ELEMENT
- 4 SPRING
- 5 INDICATOR PORT
- 6 SEAL KIT
- 7 SCREWS
- 8 COVER

SPARE SEALS KIT

	NBR	FKM
FRT-20/22/30/31	06.021.00171	06.021.00175
FRT-40/43/45	06.021.00172	06.021.00176
FRT-50/51/60/64/66	06.021.00173	06.021.00177

COVER SCREW TIGHTENING TORQUE

M6	10 Nm
M8	25 Nm

INDICATOR TIGHTENING TORQUE

10 Nm

WARNING

- ⚠ Make sure that Personal Protective Equipment (PPE) is worn during installation and maintenance operation.

DISPOSAL OF FILTER ELEMENT

- ⚠ The used filter elements and the filter parts dirty of oil are classified as "Dangerous waste material": they must be disposed according to the local laws by authorized Companies.

INSTALLATION

1. the filter head (1) must be properly positioned and well secured on the tank lid through the fixing holes
2. the hose must be properly connected to the IN port
- ⚠ 3. the OUT port must be clear (an extension tube could be fitted, if needed for having the outlet below the oil level), at least it's suggested the diffuser
4. verify that no tension is present on the filter after mounting
5. enough space must be available for filter element replacement
6. the visual clogging indicator must be in a easily viewable position
7. when a electrical indicator is used, make sure that it is properly wired
8. keep in stock a spare FILTREC filter element for timely replacement when required

OPERATION

- ⚠ 1. the filter must work within the operating conditions of pressure, temperature and compatibility given in the first page of this data sheet
2. the filter element must be replaced as soon as the clogging indicator signals at working temperature
3. If no clogging indicator is mounted, replace the element according to the system manufacturer's recommendations

MAINTENANCE

- ⚠ 1. before removing the top cover from the head, ensure that the system is switched off and there is no residual pressure in the filter
2. unscrew the fixing bolts of the top cover and remove it
3. remove the spring (4) first, then the dirty element (3) and the bowl (2)
4. clean the bowl (2) and fit a new FILTREC element (3), verifying the part number, particularly concerning the micron rating
5. when fitting the new element (3), open its plastic protection on the open end side and insert it onto the spigot in the filter bowl, then remove completely the plastic protection
6. check the top cover O-ring conditions and replace if necessary
7. put the spring (4) in its position on the filter element (3)
8. mount the top cover onto the head and fix it screwing the fixing bolts
- ⚠ 9. the used filter elements cannot be cleaned and re-used



Technical information may change without notice.
CT91-rev.00-09/21