



## FRP SERIES

Tank top return filter

The FRP Series features:

- With or without inbuilt air breather
- With 2, 4 or 6 tank mounting holes
- Flow rate up to 300 l/min
- With double tank mounting pattern
- With anti emptying back pressure valve (AEB valve)



### HOUSING

tested according to NFPA T3.10.5.1\*, ISO 10771\*, ISO 3968

**PRESSURE:** Max operating: 10 bar

**CONNECTION:** G 1 1/2"

**MATERIALS:** Head: aluminium alloy  
Bowl and top cover: PA6 reinforced  
Seal: NBR

**BYPASS VALVE:** Inbuilt in the filter element  
C version 3 bar

### ELEMENT

tested according to ISO 11170, 2941, 2942, 2943, 3724, 3968, 16889, 16908, 23181

**FILTER MEDIA:** Inorganic microfiber  
G06 - G10 - G15 - G25 - G40  
Paper: C10  
Synthetic: M05 - M10 - M15  
Metal wire mesh: T60

**COLLAPSE PRESSURE:** 10 bar

**TEMPERATURE RANGE:** -30°C +100°C

**FLUID COMPATIBILITY:** Full with HH-HL-HM-HV  
HETG-HEES (acc. to ISO 6743/4).  
For use with other fluid please  
contact Filtrec Customer Service  
(info@filtrec.it).

\* as reference method only for verifying the pressure fatigue resistance and establishing the burst pressure ratings.

## OVERALL DIMENSIONS

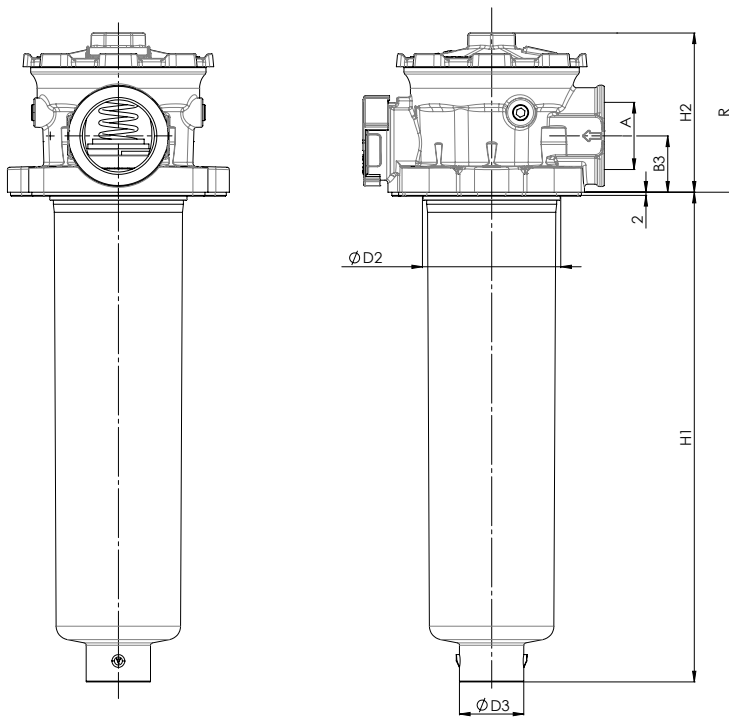

TANK HOLES DIMENSIONS  
2 fixing threads

TANK HOLES DIMENSIONS  
4 fixing threads

COMMON PATTERN FOR  
VERSIONS "6A" AND "6B"

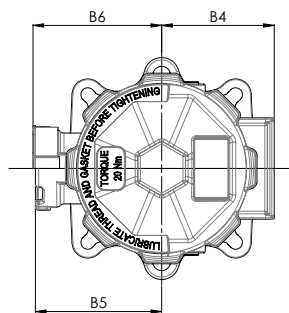
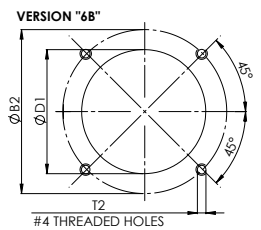
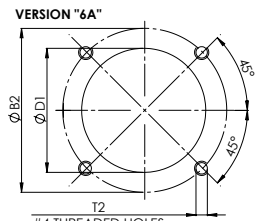
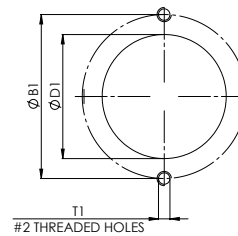

## NOMINAL SIZE

MODEL	A	Ø D1	Ø D2	D3	Ø B1	Ø B2	T1	T2	B3	B4	B5	B6	H1	H2	R	WEIGHT Kg
FRP R136	6A	G 1 1/2"	87/95	86	40	112/116	M10	M10	35	70	78,5	80	305	99	420	1.5
	6B							M8								

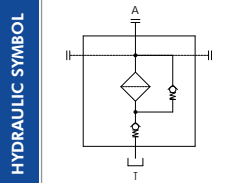

## ORDERING INFORMATION

1.	2.	3.	4.	5.	6.	7.	8.	9.	10.	11.	12.
<b>FRP</b>	<b>6B</b>	<b>R1</b>	<b>36</b>	<b>G10</b>	<b>C</b>	<b>B</b>	<b>B7</b>	<b>A</b>	<b>1</b>	<b>B</b>	<b>000</b>
SPARE ELEMENT		<b>R1</b>	<b>36</b>	<b>G10</b>	<b>C</b>						

1. FILTER SERIES	FRP	
2. TANK MOUNTING HOLES	6A	2 holes tank pattern Ø 112-116mm M10 / 4 holes tank pattern Ø 114-116mm M10
	6B	2 holes tank pattern Ø 112-116mm M10 / 4 holes tank pattern Ø 126-130mm M8
3. FILTER ELEMENT SERIES	R1	
4. FILTER SIZE	36	
5. FILTER MEDIA	000	without filter element
	G06	glassfiber $\beta_{7\mu\text{m(c)}} > 1.000$
	G10	glassfiber $\beta_{12\mu\text{m(c)}} > 1.000$
	G15	glassfiber $\beta_{17\mu\text{m(c)}} > 1.000$
	G25	glassfiber $\beta_{22\mu\text{m(c)}} > 1.000$
	G40	glassfiber $\beta_{35\mu\text{m(c)}} > 1.000$
	C10	paper $\beta_{10\mu\text{m(c)}} > 2$
	T60	wire mesh 60 $\mu\text{m}$
	M05	synthetic $\beta_{10\mu\text{m(c)}} > 1.000$
	M10	synthetic $\beta_{15\mu\text{m(c)}} > 1.000$
M15	synthetic $\beta_{20\mu\text{m(c)}} > 1.000$	
6. BYPASS VALVE	C	3 bar
7. SEALS	B	NBR
8. CONNECTION PORT	B7	G 1 1/2"
9. AEB VALVE	A	anti emptying back pressure valve 0,4 bar
AEB=anti emptying back pressure valve		
10. INBUILT AIR BREATHER	0	no air breather
	1	with air breather
11. INDICATOR PORT	B	2 x G 1/8"
12. CLOGGING INDICATORS	000	without indicator
	MPC	pressure gauge rear connection
	MRC	pressure gauge radial connection
	PDC	pressure switch
ACCESSORIES	LC24	LED connector for pressure switch
The accessories must be ordered separately	DS350	dipstick (available only for FRP 6A)
	ET2250	extension tube 250 mm long
	ET2500	extension tube 500 mm long
	CT2250	connection tube 250 mm long
	DF040	diffuser Ø 40 mm
	B610F03	spare air breather

## PRESSURE DROP ( $\Delta p$ ) INFORMATION FOR FILTER SIZING

The total Delta P through a filter assembly is given from Housing  $\Delta p$  + Element  $\Delta p$ .

The max recommended total  $\Delta p$  for return filters with anti emptying back pressure valve is 0.8 - 1.0 bar with clean element.

N.B. All the reported data have been obtained at our laboratory, according to specification ISO3968 with mineral oil having 32 cSt viscosity at 40°C and density 0,875 kg/dm<sup>3</sup>.

## HOUSING PRESSURE DROP

The housing  $\Delta p$  is given by the curve of the considered model and port, in correspondence of the flow rate value.

FRP with AEB valve

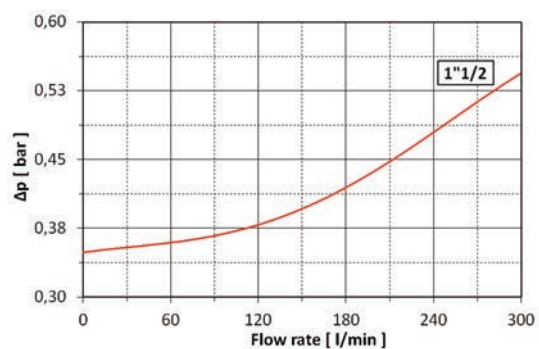

## ELEMENT PRESSURE DROP

The element  $\Delta p$  (bar) is given by the flow rate (l/min) multiplied by the factor in the table here below corresponding to the selected media and divided by 1000.

If the oil has a viscosity  $V_1$  different than 32 cSt a corrective factor  $V_1/32$  must be applied.

Example: 80 l/min with R136G10C and oil viscosity 46 cSt  $> 80 \times 2,06/1000 \times 46/32 = 0,24$  bar

	G06	G10	G15	G25	G40	C10	T60	M05	M10	M15
R136	3,54	2,06	1,58	1,45	0,56	1,24	0,28	1,52	1,35	0,72

## EXAMPLE OF TOTAL $\Delta p$ CALCULATION

FRP6BR136G10CBB7A1B000 with **80** l/min and oil **46** cSt:

Housing  $\Delta p$  0,36 bar + element  $\Delta p$  0,24 bar ( $80 \times 2,06/1000 \times 46/32$ ) = total assembly  $\Delta p$  0,6 bar

## BYPASS VALVE PRESSURE DROP

The bypass valve  $\Delta p$  is given by the curve of the considered model and setting, in correspondence of the flow rate value.

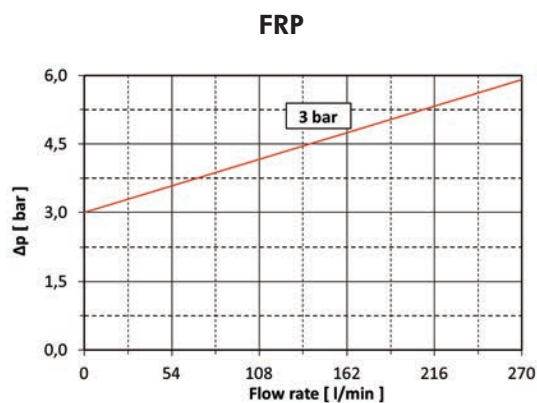

## ACCESSORIES

These accessories fit all our standard models and must be ordered separately.



### A \* DIPSTICK for oil level detection

When reduced space available, one of the tank fixing hole can be used for a dipstick to check the oil level; it is supplied with a M10 bolt support.

\*available only for FRP 6A

DS350	dipstick 350 mm long
-------	----------------------

### B AIR BREATHER

PART NR.	FILTRATION	FLOW RATE	$\Delta p$
B610F03	3 $\mu\text{m}$	up to 300 NI/min	50 mbar

N.B. we recommend to replace the air breather when replacing the oil filter element.

(when working in a very dirt environment, a more frequent air breather replacement could be necessary)

### C EXTENSION TUBE

The flow from the filter must come out below the oil level to avoid possible generation of free air or foam.

When necessary an extension tube can be fitted onto the knobs of the bowl end.

ET2250	extension tube 250 mm long
--------	----------------------------

ET2500	extension tube 500 mm long
--------	----------------------------

### D CONNECTION TUBE

Connection tube is the necessary device between filter bowl and extension tubes (ET2250/ET2550) and/or diffuser (DF040). Its plug and play option makes it easy to install and versatile.

CT2250	connection tube 250 mm long
--------	-----------------------------

### E DIFFUSER

Diffuser is an effective way to reduce foaming and turbulence normally caused by return lines. Plug and play option to be directly installed on the filter bowl or to connection tube (CT2250). Installation of a diffuser in the hydraulic tank is an easy way to ensure the reliability of the overall system.

Diffuser must always be installed below the minimum oil level.

DF040	diffuser $\varnothing$ 40 mm
-------	------------------------------

## USER TIPS



- 1 COVER
- 2 SPRING
- 3 O-RING
- 4 FILTER ELEMENT
- 5 FILTER BOWL+AEB VALVE
- 6 FILTER HEAD
- 7 SHAPED GASKET
- 8 AIR BREATHER

### SPARE SEALS KIT

	NBR
FRP-6A-R12x/3x	06.021.00310
FRP-6B-R12x/3x	06.021.00311

### COVER TIGHTENING TORQUE

20 Nm

### INDICATOR TIGHTENING TORQUE

10 Nm

### WARNING

-  Make sure that Personal Protective Equipment (PPE) is worn during installation and maintenance operation.

### DISPOSAL OF FILTER ELEMENT

-  The used filter elements and the filter parts dirty of oil are classified as "Dangerous waste material": they must be disposed according to the local laws by authorized Companies.



## INSTALLATION

1. the gasket (7) must be properly positioned and the head (6) well secured on the tank lid through the fixing holes
2. the hose must be properly connected to the IN port
-  3. the OUT port must be clear (an extension tube could be fitted, if needed for having the outlet below the oil level)
4. verify that no tension is present on the filter after mounting
5. when present the air breather (8), it must be in a protected position
6. enough space must be available for filter element replacement
7. the visual clogging indicator must be in a easily viewable position
8. when a electrical indicator is used, make sure that it is properly wired
9. keep in stock a spare FILTREC filter element for timely replacement when required

## OPERATION

-  1. the filter must work within the operating conditions of pressure, temperature and compatibility given in the first page of this data sheet
- 2. the filter element must be replaced as soon as the clogging indicator signals at working temperature (in cold start conditions, oil temperature lower than 30°C, a false alarm can be given due to oil viscosity)
- 3. If no clogging indicator is mounted, replace the element according to the system manufacturer's recommendations

## MAINTENANCE

-  1. before removing the cover (1), ensure that the system is switched off and there is no residual pressure in the filter
- 2. unscrew the cover (1) by turning it anti-clockwise and remove it
- 3. remove the spring (2) first, then the dirty element (4) and the bowl (5)
- 4. clean the bowl (5) and fit a new FILTREC element (4), verifying the part number, particularly concerning the micron rating
- 5. when fitting the new element (4), open its plastic protection on the open end side and insert it onto the spigot in the filter bowl, then remove completely the plastic protection
- 6. check the O-ring (3) conditions and replace if necessary
- 7. put the spring (2) in its position on the filter element
- 8. screw the cover (1) by turning it clockwise, tighten at the recommended torque
-  9. the used filter elements cannot be cleaned and re-used

