

# HYDRAULIC VALVES

# FLOWFIT

# CETOP

# VALVES

PRODUCT	PAGE
FLOWFIT CETOP 3	88
FLOWFIT CETOP 5	97
FLOWFIT CETOP 7	105
FLOWFIT CETOP 8	109
KOMPASS RELIEF VALVES	113
KOMPASS SEQUENCE, COUNTER BALANCE & UNLOADING	115
2 WAY CARTRIDGE ELECTRIC VALVES	116
KOMPASS ELECTRO-HYDRAULIC PROPORTIONAL VALVES	116



**FROM ONLY**  
**£50.63**  
+VAT



**FROM ONLY**  
**£93.47**  
+VAT



**FROM ONLY**  
**£37.65**  
+VAT



**QUALITY PRODUCTS**



**FREE ADVICE**

**FOR SALES & ADVICE**  
**CALL US**  
**01584**  
**876033**

## FLOWFIT CETOP 3 NG6 SOLENOID DIRECTIONAL CONTROL VALVE

Flowfit offer a large range of solenoid operated CETOP 3 NG6 with a maximum flow of 80 l/min, commonly used in powerpacks and other hydraulic applications. Available in 12VDC, 24VDC, 110VAC and 220VAC.

Flowfit F5-02 series CETOP 3 NG6 solenoid valves are Electro-Hydraulic spool type valves. They are solenoid operated and control the start, stop and direction of the oil flow in the hydraulic circuit.

They are used for hydraulic powerpacks as well as for stand alone hydraulic manifold blocks.

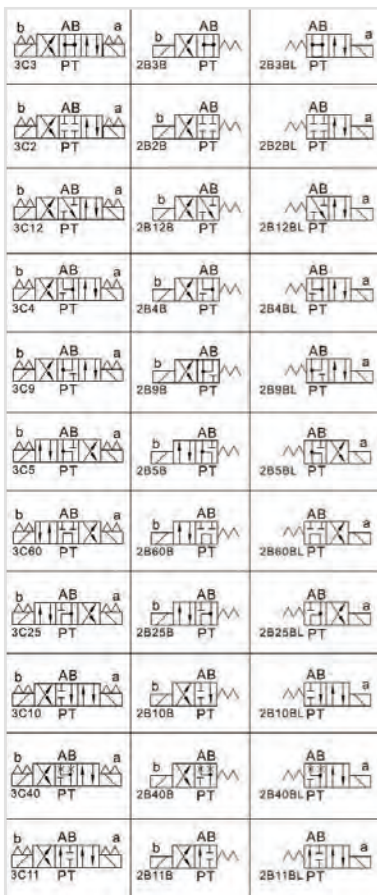

### SPECIFICATION

**Nominal Size:** NG6  
**Maximum Flow Rate:** 80 l/min  
**Maximum Pressure:** A,B,P = 315 Bar T = 16 Bar  
**Seal Material:** NBR  
**Max Fluid Temperature:** -20° to 70°C  
**Oil Viscosity:** -2.8 to 380 mm<sup>2</sup>/s  
**Switch Cycles** Open: 50 ~ 60ms  
 Closed: 50 ~ 70ms  
**Switch Frequency:** 15000 times per hour  
**Insulation Grade:** IP65  
**Weight:** Single Solenoid: 1.5kg,  
 Double Solenoid: 2.2kg  
**Voltagess:** 12VDC = D1, 24VDC = D2,  
 110V/AC 50HZ = A1, 220V/AC 50HZ = A2  
**Manual Override:** Standard on all valves  
**Connector Type:** DIN Plug (with LED)

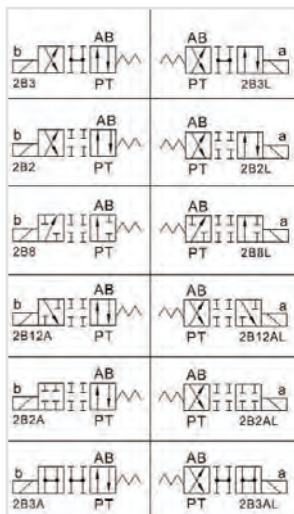

### FLOWFIT CETOP 3 NG6 SPRING CENTERED 3 POSITION DOUBLE ACTING SOLENOID DIRECTIONAL CONTROL VALVE

PRODUCT REFERENCE	DOUBLE SOLENOID	CONFIGURATION	SPOOL RETURN	NETT. PRICE	
				£ STERLING	€ EUROS
F5-02-3C2-**	Double	3 Position	Spring	£50.63	€ 68.35
F5-02-3C3-**	Double	3 Position	Spring	£50.63	€ 68.35
F5-02-3C4-**	Double	3 Position	Spring	£50.63	€ 68.35
F5-02-3C5-**	Double	3 Position	Spring	£50.63	€ 68.35
F5-02-3C9-**	Double	3 Position	Spring	£50.63	€ 68.35
F5-02-3C10-**	Double	3 Position	Spring	£50.63	€ 68.35
F5-02-3C11-**	Double	3 Position	Spring	£50.63	€ 68.35
F5-02-3C12-**	Double	3 Position	Spring	£50.63	€ 68.35
F5-02-3C25-**	Double	3 Position	Spring	£50.63	€ 68.35
F5-02-3C40-**	Double	3 Position	Spring	£50.63	€ 68.35
F5-02-3C60-**	Double	3 Position	Spring	£50.63	€ 68.35

**NOTE: SUBSTITUTE THE \*\* WITH VOLTAGE PREFERENCE. 12VDC=D1, 24VDC=D2, 110V/AC 50HZ=A1, 220V/AC 50HZ=A2**

FLOWFIT CETOP 3 NG6 SPRING OFFSET 2 POSITION SINGLE ACTING SOLENOID DIRECTIONAL CONTROL VALVE					
PRODUCT REFERENCE	SINGLE SOLENOID	CONFIGURATION	SPOOL RETURN	NETT. PRICE	
				£ STERLING	€ EUROS
F5-02-2B2-**	Single	2 Position	Spring	£37.65	€ 50.82
F5-02-2B2L-**	Single	2 Position	Spring	£37.65	€ 50.82
F5-02-2B2A-**	Single	2 Position	Spring	£37.65	€ 50.82
F5-02-2B2AL-**	Single	2 Position	Spring	£37.65	€ 50.82
F5-02-2B2B-**	Single	2 Position	Spring	£37.65	€ 50.82
F5-02-2B2BL-**	Single	2 Position	Spring	£37.65	€ 50.82
F5-02-2B3-**	Single	2 Position	Spring	£37.65	€ 50.82
F5-02-2B3L-**	Single	2 Position	Spring	£37.65	€ 50.82
F5-02-2B3A-**	Single	2 Position	Spring	£37.65	€ 50.82
F5-02-2B3AL-**	Single	2 Position	Spring	£37.65	€ 50.82
F5-02-2B3B-**	Single	2 Position	Spring	£37.65	€ 50.82
F5-02-2B3BL-**	Single	2 Position	Spring	£37.65	€ 50.82
F5-02-2B4B-**	Single	2 Position	Spring	£37.65	€ 50.82
F5-02-2B4BL-**	Single	2 Position	Spring	£37.65	€ 50.82
F5-02-2B5B-**	Single	2 Position	Spring	£37.65	€ 50.82
F5-02-2B5BL-**	Single	2 Position	Spring	£37.65	€ 50.82
F5-02-2B8-**	Single	2 Position	Spring	£37.65	€ 50.82
F5-02-2B8L-**	Single	2 Position	Spring	£37.65	€ 50.82
F5-02-2B9B-**	Single	2 Position	Spring	£37.65	€ 50.82
F5-02-2B9BL-**	Single	2 Position	Spring	£37.65	€ 50.82
F5-02-2B10B-**	Single	2 Position	Spring	£37.65	€ 50.82
F5-02-2B10BL-**	Single	2 Position	Spring	£37.65	€ 50.82
F5-02-2B11B-**	Single	2 Position	Spring	£37.65	€ 50.82
F5-02-2B11BL-**	Single	2 Position	Spring	£37.65	€ 50.82
F5-02-2B12A-**	Single	2 Position	Spring	£37.65	€ 50.82
F5-02-2B12AL-**	Single	2 Position	Spring	£37.65	€ 50.82
F5-02-2B12B-**	Single	2 Position	Spring	£37.65	€ 50.82

NOTE: SUBSTITUTE THE \*\* WITH VOLTAGE PREFERENCE. 12VDC=D1, 24VDC=D2, 110V/AC 50HZ=A1, 220V/AC 50HZ=A2

SPRING CENTERED 2 POSITION SOLENOID DIRECTIONAL CONTROL VALVE					
PRODUCT REFERENCE	SINGLE SOLENOID	CONFIGURATION	SPOOL RETURN	NETT. PRICE	
				£ STERLING	€ EUROS
F5-02-2B12BL-**	Single	2 Position	Spring	£37.65	€ 50.82
F5-02-2B25B-**	Single	2 Position	Spring	£37.65	€ 50.82
F5-02-2B25BL-**	Single	2 Position	Spring	£37.65	€ 50.82
F5-02-2B40B-**	Single	2 Position	Spring	£37.65	€ 50.82
F5-02-2B40BL-**	Single	2 Position	Spring	£37.65	€ 50.82
F5-02-2B60B-**	Single	2 Position	Spring	£37.65	€ 50.82
F5-02-2B60BL-**	Single	2 Position	Spring	£37.65	€ 50.82

NOTE: SUBSTITUTE THE \*\* WITH VOLTAGE PREFERENCE. 12VDC=D1, 24VDC=D2, 110V/AC 50HZ=A1, 220V/AC 50HZ=A2

## FLOWFIT CETOP 3 HAND OPERATED DIRECTIONAL CONTROL VALVES



MAXIMUM FLOW: 30 l/min  
MAXIMUM PRESSURE: 250 Bar

SEE SPOOL CONFIGURATIONS ON PREVIOUS PAGE

www.flowfitonline.com  
TECH. DATA SHEET  
**FCV2**

SUBPLATE	SPRING CENTRED	DETENT	NETT. PRICE	
			£ STERLING	€ EUROS
DMG-02-*	W	*****	£120.51	€ 162.68
DMG-02-*	*****	O	£115.71	€ 156.21

## FLOWFIT CETOP 3 NG6 MODULAR RELIEF VALVE

www.flowfitonline.com  
TECH. DATA SHEET  
**FCV3**

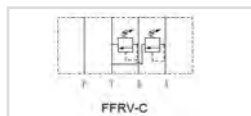
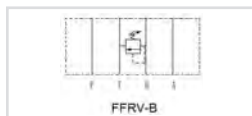
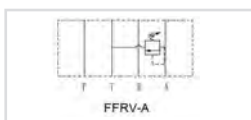
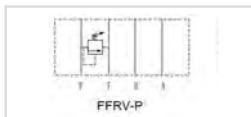

The Flowfit CETOP 3 NG6 Modular Relief Valve is available in a variety of configurations to control pressure in either the P, A or B ports.

There are three pressure ranges to choose from, providing the versatility to control system pressure in any application.

Pressure can be adjusted using the plastic knob (standard on all modular relief valves) but for added security, valves can also be supplied with an adjustment screw that can be locked once pressure has been set (Available upon request).

The pressure ranges available are:

- 8 - 70bar
- 35 - 140bar
- 70 - 250bar

### SPECIFICATION

**Nominal Size:** NG6  
**Maximum Flow Rate:** 35 l/min  
**Maximum Pressure:** 250 Bar  
**Seal Material:-** NBR  
**Max Fluid Temperature:** -20° to 70°C  
**Oil Viscosity:** -2.8 to 380 mm2/s  
**Weight P, A, B:** 1.5kg  
**C:** 1.7kg  
**Manual Adjustment:** Standard on all valves

PRODUCT REFERENCE	DESCRIPTION	NETT. PRICE	
		£ STERLING	€ EUROS
FFRV-02P-K-1-20	CETOP 3 MODULAR RELIEF VALVE 8-70BAR ON P	£38.49	€ 51.96
FFRV-02P-K-2-20	CETOP 3 MODULAR RELIEF VALVE 35-140BAR ON P	£38.49	€ 51.96
FFRV-02P-K-3-20	CETOP 3 MODULAR RELIEF VALVE 70-250BAR ON P	£60.37	€ 81.51
FFRV-02A-K-1-20	CETOP 3 MODULAR RELIEF VALVE 8-70BAR ON A	£38.49	€ 51.96
FFRV-02A-K-2-20	CETOP 3 MODULAR RELIEF VALVE 35-140BAR ON A	£42.84	€ 57.83
FFRV-02A-K-3-20	CETOP 3 MODULAR RELIEF VALVE 70-250BAR ON A	£38.49	€ 51.96
FFRV-02B-K-1-20	CETOP 3 MODULAR RELIEF VALVE 8-70BAR ON B	£42.84	€ 57.83
FFRV-02B-K-2-20	CETOP 3 MODULAR RELIEF VALVE 35-140BAR ON B	£42.84	€ 57.83
FFRV-02B-K-3-20	CETOP 3 MODULAR RELIEF VALVE 70-250BAR ON B	£42.84	€ 57.83
FFRV-02C-K-1-20	CETOP 3 MODULAR RELIEF VALVE 8-70BAR ON A+B	£38.49	€ 51.96
FFRV-02C-K-2-20	CETOP 3 MODULAR RELIEF VALVE 35-140BAR ON A+B	£38.49	€ 51.96
FFRV-02C-K-3-20	CETOP 3 MODULAR RELIEF VALVE 70-250BAR ON A+B	£60.36	€ 81.49

## FLOWFIT CETOP 3 NG6 MODULAR REDUCING VALVE

www.flowfitonline.com  
TECH. DATA SHEET  
**FCV4**

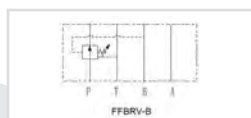
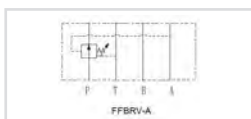

The Flowfit modular reducing valve is designed to lower the pressure in a specific circuit compared to the main system pressure.

There are three pressure ranges to choose from, providing the versatility to control individual circuit pressure.

Pressure can be adjusted using the plastic knob (standard on all modular reducing valves) but for added security, valves can also be supplied with an adjustment screw that can be locked once pressure has been set (Available upon request).

The pressure ranges available are:

- 8 - 70bar
- 35 - 140bar
- 70 - 250bar

### SPECIFICATION

**Nominal Size:** NG6  
**Maximum Flow Rate:** 35 l/min  
**Maximum Pressure:** 250 Bar  
**Seal Material:-** NBR  
**Max Fluid Temperature:** -20° to 70°C  
**Oil Viscosity:** -2.8 to 380 mm2/s  
**Weight:** 1.2kg  
**Manual Adjustment:** Standard on all valves

PRODUCT REFERENCE	DESCRIPTION	NETT. PRICE	
		£ STERLING	€ EUROS
FFBRV-02P-K-1-20	CETOP 3 MODULAR REDUCING VALVE 8-70BAR ON P	£42.84	€ 57.83
FFBRV-02P-K-2-20	CETOP 3 MODULAR REDUCING VALVE 35-140BAR ON P	£42.84	€ 57.83
FFBRV-02P-K-3-20	CETOP 3 MODULAR REDUCING VALVE 70-250BAR ON P	£38.49	€ 51.96
FFBRV-02A-K-1-20	CETOP 3 MODULAR REDUCING VALVE 8-70BAR ON A	£42.84	€ 57.83
FFBRV-02A-K-2-20	CETOP 3 MODULAR REDUCING VALVE 35-140BAR ON A	£42.84	€ 57.83
FFBRV-02A-K-3-20	CETOP 3 MODULAR REDUCING VALVE 70-250BAR ON A	£42.84	€ 57.83
FFBRV-02B-K-1-20	CETOP 3 MODULAR REDUCING VALVE 8-70BAR ON B	£42.84	€ 57.83
FFBRV-02B-K-2-20	CETOP 3 MODULAR REDUCING VALVE 35-140BAR ON B	£42.84	€ 57.83
FFBRV-02B-K-3-20	CETOP 3 MODULAR REDUCING VALVE 70-250BAR ON B	£42.84	€ 57.83

# FLOWFIT CETOP 3 NG6 MODULAR CHECK VALVE

www.flowfitonline.com  
TECH. DATA SHEET  
**FCV5**

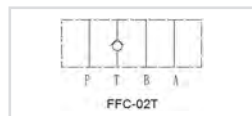
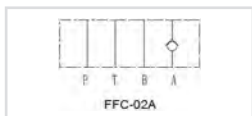
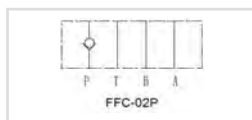
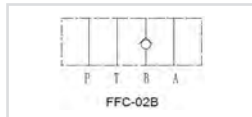

The Flowfit modular check valve allows free flow in one direction and blocks the flow in the opposite direction.

Flowfit check valves are available for the A, B, P or T port and can be specified with a cracking pressure of 0.35bar or 3.5bar depending on the system requirements.

**SPECIFICATION**

- Nominal Size:** NG6
- Maximum Flow Rate:** 35 l/min
- Maximum Pressure:** 250 Bar
- Seal Material:** - NBR
- Max Fluid Temperature:** -20° to 70°C
- Oil Viscosity:** -2.8 to 380 mm2/s
- Weight:** 1.2kg
- Manual Adjustment:** Standard on all valves

PRODUCT REFERENCE	DESCRIPTION	NETT. PRICE	
		£ STERLING	€ EUROS
FFC-02P-05-20	CETOP 3 MODULAR CHECK VALVE C/P 0.35BAR ON P	£36.74	€ 49.60
FFC-02P-50-20	CETOP 3 MODULAR CHECK VALVE C/P 3.5BAR ON P	£35.06	€ 47.33
FFC-02A-05-20	CETOP 3 MODULAR CHECK VALVE C/P 0.35BAR ON A	£36.74	€ 49.60
FFC-02A-50-20	CETOP 3 MODULAR CHECK VALVE C/P 3.5BAR ON A	£35.06	€ 47.33
FFC-02B-05-20	CETOP 3 MODULAR CHECK VALVE C/P 0.35BAR ON B	£35.06	€ 47.33
FFC-02B-50-20	CETOP 3 MODULAR CHECK VALVE C/P 3.5BAR ON B	£35.06	€ 47.33
FFC-02T-05-20	CETOP 3 MODULAR CHECK VALVE C/P 0.35BAR ON T	£35.06	€ 47.33
FFC-02T-50-20	CETOP 3 MODULAR CHECK VALVE C/P 3.5BAR ON T	£35.06	€ 47.33

# FLOWFIT CETOP 3 NG6 MODULAR PILOT OPERATED CHECK VALVE

www.flowfitonline.com  
TECH. DATA SHEET  
**FCV6**

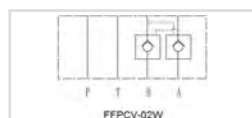
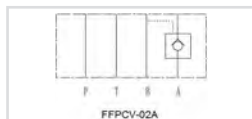

The Flowfit modular pilot operated (P/O) check valve allows free flow in one direction and pilot pressure allows flow in the opposite direction.

Flowfit pilot operated check valves are available for the A or B ports individually, or the A and B ports combined. They can be specified with a cracking pressure of 0.35bar or 3.5bar depending on the system requirements

**SPECIFICATION**

- Nominal Size:** NG6
- Maximum Flow Rate:** 35 l/min
- Maximum Pressure:** 250 Bar
- Seal Material:** - NBR
- Max Fluid Temperature:** -20° to 70°C
- Oil Viscosity:** -2.8 to 380 mm2/s
- Weight:** 1.1kg

PRODUCT REFERENCE	DESCRIPTION	NETT. PRICE	
		£ STERLING	€ EUROS
FFPCV-02A-05-20	CETOP 3 MODULAR P/O CHECK VALVE C/P 0.35BAR ON A	£38.94	€ 52.57
FFPCV-02A-50-20	CETOP 3 MODULAR P/O CHECK VALVE C/P 3.5BAR ON A	£38.94	€ 52.57
FFPCV-02B-05-20	CETOP 3 MODULAR P/O CHECK VALVE C/P 0.35BAR ON B	£38.94	€ 52.57
FFPCV-02B-50-20	CETOP 3 MODULAR P/O CHECK VALVE C/P 3.5BAR ON B	£40.90	€ 55.21
FFPCV-02W-05-20	CETOP 3 MODULAR P/O CHECK VALVE C/P 0.35BAR ON A AND B	£40.90	€ 55.21
FFPCV-02W-50-20	CETOP 3 MODULAR P/O CHECK VALVE C/P 3.5BAR ON A AND B	£36.74	€ 49.60

## FLOWFIT CETOP 3 NG6 MODULAR FLOW CONTROL VALVE WITH CHECK

www.flowfitonline.com  
TECH. DATA SHEET  
**FCV7**

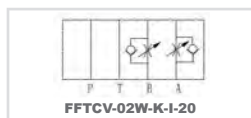
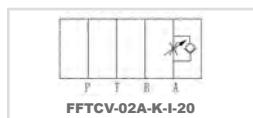
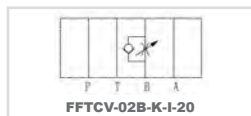
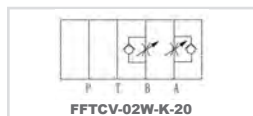
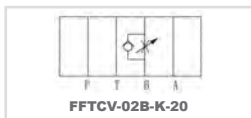
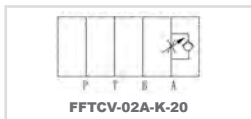

The Flowfit modular flow control valves regulate the flow of oil through the circuit in one direction whilst allowing free flow in the opposite direction using a check valve.

Two types of valve are available; the first meters the flow of oil into the circuit (allowing free flow out), while the second meters the flow out of the circuit (allowing free flow in).

Flow on the metered side can be adjusted using the plastic knob (standard on all modular flow control valves) but for added security, valves can also be supplied with an adjustment screw that can be locked once the desired flow has been set (Available upon request).

### SPECIFICATION

**Nominal Size:** NG6  
**Maximum Flow Rate:** 35 l/min  
**Maximum Pressure:** 250 Bar  
**Seal Material:** NBR  
**Max Fluid Temperature:** -20° to 70°C  
**Oil Viscosity:** -2.8 to 380 mm<sup>2</sup>/s  
**Weight:** A, B 1.2kg  
W 1.4kg  
**Manual Adjustment:** Standard on all valves

PRODUCT REFERENCE	DESCRIPTION	NETT. PRICE	
		£ STERLING	€ EUROS
FFTCV-02A-K-20	CETOP 3 MODULAR FLOW CONTROL VALVE MTR OUT ON A PORT	£42.84	€ 57.83
FFTCV-02A-K-I-20	CETOP 3 MODULAR FLOW CONTROL VALVE MTR IN ON A PORT	£42.84	€ 57.83
FFTCV-02B-K-20	CETOP 3 MODULAR FLOW CONTROL VALVE MTR OUT ON B PORT	£42.84	€ 57.83
FFTCV-02B-K-I-20	CETOP 3 MODULAR FLOW CONTROL VALVE MTR IN ON B PORT	£42.84	€ 57.83
FFTCV-02W-K-20	CETOP 3 MODULAR FLOW CONTROL VALVE MTR OUT ON A+B PORT	£42.84	€ 57.83
FFTCV-02W-K-I-20	CETOP 3 MODULAR FLOW CONTROL VALVE MTR IN ON A+B PORT	£42.84	€ 57.83

## FLOWFIT CETOP 3 NG6 MODULAR COUNTER BALANCE VALVE

www.flowfitonline.com  
TECH. DATA SHEET  
**FCV8**

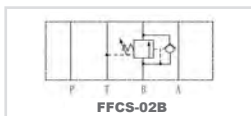
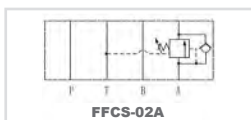

The Flowfit modular counter balance valve is designed to equalize the pressure in a specific line of a hydraulic system.

Pressure can be adjusted using the plastic knob (standard on all modular counter balance valves) but for added security, valves can also be supplied with an adjustment screw that can be locked once pressure has been set (Available upon request).

The pressure ranges available are:

8 - 70bar  
35 - 140bar  
70 - 250bar

### SPECIFICATION

**Nominal Size:** NG6  
**Maximum Flow Rate:** 35 l/min  
**Maximum Pressure:** 250 Bar  
**Seal Material:** NBR  
**Max Fluid Temperature:** -20° to 70°C  
**Oil Viscosity:** -2.8 to 380 mm<sup>2</sup>/s  
**Weight:** 1.5kg  
**Manual Adjustment:** Standard on all valves

PRODUCT REFERENCE	DESCRIPTION	NETT. PRICE	
		£ STERLING	€ EUROS
FFCS-02A-K-1-20	CETOP 3 MODULAR COUNTER BALANCE VALVE 8-70BAR ON A LINE	£36.74	€ 49.60
FFCS-02A-K-2-20	CETOP 3 MODULAR COUNTER BALANCE VALVE 35-140BAR ON A LINE	£36.74	€ 49.60
FFCS-02A-K-3-20	CETOP 3 MODULAR COUNTER BALANCE VALVE 70-250BAR ON A LINE	£77.89	€ 105.15
FFCS-02B-K-1-20	CETOP 3 MODULAR COUNTER BALANCE VALVE 8-70BAR ON B LINE	£36.74	€ 49.60
FFCS-02B-K-2-20	CETOP 3 MODULAR COUNTER BALANCE VALVE 35-140BAR ON B LINE	£77.89	€ 105.15
FFCS-02B-K-3-20	CETOP 3 MODULAR COUNTER BALANCE VALVE 70-250BAR ON B LINE	£77.89	€ 105.15

# FLOWFIT CETOP 3 SEQUENCE VALVES

www.flowfitonline.com  
TECH. DATA SHEET  
**FCV11**

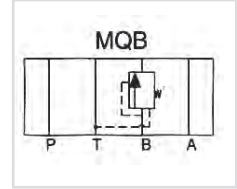
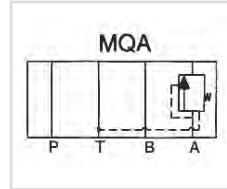
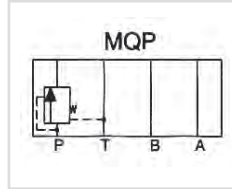

CODE	DESCRIPTION	NETT. PRICE	
		£ STERLING	€ EUROS
MQP-02-★	CETOP 3 SEQUENCE VALVE ON P PORT	£132.29	€ 178.60
MQA-02-B	CETOP 3 SEQUENCE VALVE ON A PORT	£132.29	€ 178.60
MQB-02-B	CETOP 3 SEQUENCE VALVE ON B PORT	£132.29	€ 178.60

B = 8 - 70 Bar, C = 35 - 140 Bar, H = 105 - 250 Bar  
02 = 40 l/m • H = Pressure Range

# FLOWFIT CETOP 3 NG6 STEEL PARALLEL CIRCUIT MANIFOLD

www.flowfitonline.com  
TECH. DATA SHEET  
**FCV12**

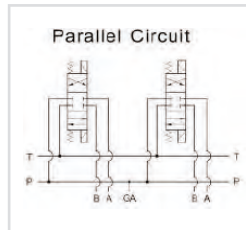

The Flowfit CETOP 3 parallel circuit manifold is precision machined from a mild steel block with sizes of 3/8" BSP for A & B ports and 1/2" BSP for P & T ports.

Flowfit manifolds are available from 1 to 10 stations with a 1/4" BSP Gauge port machined as standard on the 2 station and above (not available on the 1 station manifold).

PRODUCT REFERENCE	DESCRIPTION	NETT. PRICE	
		£ STERLING	€ EUROS
MD-03P-1-G	CETOP 3 1 STATION STEEL MANIFOLD NO RV CAVITY	£23.37	€ 31.55
MD-03P-2-G	CETOP 3 2 STATION STEEL MANIFOLD NO RV CAVITY	£42.84	€ 57.83
MD-03P-3-G	CETOP 3 3 STATION STEEL MANIFOLD NO RV CAVITY	£62.96	€ 85.00
MD-03P-4-G	CETOP 3 4 STATION STEEL MANIFOLD NO RV CAVITY	£85.69	€ 115.68
MD-03P-5-G	CETOP 3 5 STATION STEEL MANIFOLD NO RV CAVITY	£109.05	€ 147.21
MD-03P-6-G	CETOP 3 6 STATION STEEL MANIFOLD NO RV CAVITY	£132.42	€ 178.76
MD-03P-7-G	CETOP 3 7 STATION STEEL MANIFOLD NO RV CAVITY	£155.79	€ 210.32
MD-03P-8-G	CETOP 3 8 STATION STEEL MANIFOLD NO RV CAVITY	£179.15	€ 241.86
MD-03P-9-G	CETOP 3 9 STATION STEEL MANIFOLD NO RV CAVITY	£202.52	€ 273.40
MD-03P-10-G	CETOP 3 10 STATION STEEL MANIFOLD NO RV CAVITY	£229.78	€ 310.21

*If the part number needed is not listed please ask the Flowfit Sales Team*

## FLOWFIT CETOP 3 NG6 STEEL PARALLEL CIRCUIT MANIFOLD WITH RELIEF VALVE CAVITY

www.flowfitonline.com  
TECH. DATA SHEET  
**FCV9**

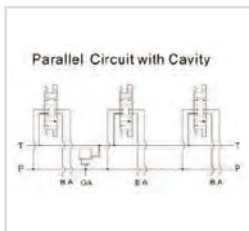

The Flowfit CETOP 3 parallel circuit manifold is precision machined from a steel block with sizes of 3/8" BSP for A & B ports and 1/2" BSP for P & T ports. The manifold also comes with a machined port for a relief valve.

Flowfit manifolds are available from 1 to 10 stations with a 1/4" BSP Gauge port machined as standard on the 2 station and above (not available on the 1 station manifold).

PRODUCT REFERENCE	DESCRIPTION	NETT. PRICE	
		£ STERLING	€ EUROS
MD-03P-1-G-M26	CETOP 3 1 STATION STEEL MANIFOLD WITH RV CAVITY	£59.96	€ 80.96
MD-03P-2-G-M26	CETOP 3 2 STATION STEEL MANIFOLD WITH RV CAVITY	£75.62	€ 102.09
MD-03P-3-G-M26	CETOP 3 3 STATION STEEL MANIFOLD WITH RV CAVITY	£102.08	€ 137.81
MD-03P-4-G-M26	CETOP 3 4 STATION STEEL MANIFOLD WITH RV CAVITY	£129.14	€ 174.33
MD-03P-5-G-M26	CETOP 3 5 STATION STEEL MANIFOLD WITH RV CAVITY	£158.91	€ 214.52
MD-03P-6-G-M26	CETOP 3 6 STATION STEEL MANIFOLD WITH RV CAVITY	£183.17	€ 247.27
MD-03P-7-G-M26	CETOP 3 7 STATION STEEL MANIFOLD WITH RV CAVITY	£214.01	€ 288.91
MD-03P-8-G-M26	CETOP 3 8 STATION STEEL MANIFOLD WITH RV CAVITY	£246.62	€ 332.94
MD-03P-9-G-M26	CETOP 3 9 STATION STEEL MANIFOLD WITH RV CAVITY	£271.52	€ 366.56
MD-03P-10-G-M26	CETOP 3 10 STATION STEEL MANIFOLD WITH RV CAVITY	£302.03	€ 407.74
VC0800/300	CETOP 3 RELIEF CARTRIDGE ONLY	£21.78	€ 29.41

**NOTE**  
VC0800/300 Cetop 3 Relief Valve Cartridge needs to be purchased when ordering 'Cetop 3 NG6 Steel Parallel Circuit with Relief Valve Cavity'.

## FLOWFIT SIDE ENTRY CETOP 3



www.flowfitonline.com  
TECH. DATA SHEET  
**FCV10**

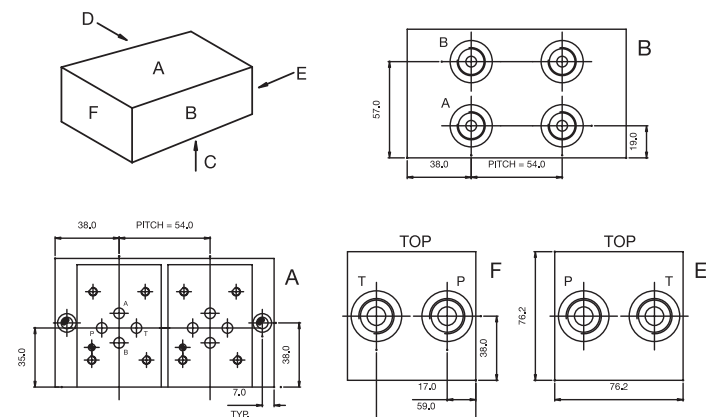

### ORDERING CODE INFORMATION

- Steel** Code No. 105161/★  
Alum. Alloy  
Available on request  
★ = Number of stations
- Material** Steel  
Alum. Alloy
- Working Pressure** Steel 315 Bar  
Alum. Alloy 250 Bar
- 'A' and 'B' Ports** 3/8" BSP
- 'P' and 'T' Ports** 1/2" BSP
- Valve Fixings** M5 x 12  
Full Thread
- Manifold Fixings** 6.8 Dia Through  
C'Bore 11 Dia x 9 dp
- Pitch** 54.0mm

SIDE ENTRY • CETOP 3					
ORDER CODE	NUMBER OF STATIONS	OVERALL LENGTH	OVERALL WEIGHT	NETT. PRICE	
				£ STERLING	€ EUROS
105161/1	ONE	76.0	3.0 Kgs	£76.00	€ 102.60
105161/2	TWO	130.0	5.3 Kgs	£112.30	€ 151.61
105161/3	THREE	184.0	7.6 Kgs	£143.46	€ 193.65
105161/4	FOUR	238.0	10.0 Kgs	£179.80	€ 242.72
105161/5	FIVE	292.0	12.2 Kgs	£226.41	€ 305.66
105161/6	SIX	346.0	14.5 Kgs	£273.27	€ 368.92
105161/7	SEVEN	400.0	16.8 Kgs	£325.72	€ 439.72
105161/8	EIGHT	454.0	19.1 Kgs	£376.97	€ 508.92



# FLOWFIT SIDE ENTRY TEST POINT CETOP 3



www.flowfitonline.com  
TECH. DATA SHEET  
**FCV13**

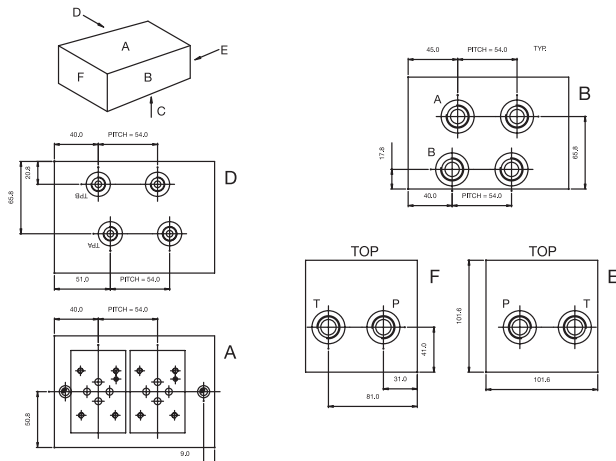

### ORDERING CODE INFORMATION

- Steel** Code No. 125161/★  
Alum. Alloy  
Available on request  
★ = Number of stations
- Material** Steel  
Alum. Alloy
- Working Pressure** Steel 315 Bar  
Alum. Alloy 250 Bar
- 'A' and 'B' Ports** 1/2" BSP  
**'P' and 'T' Ports** 1/2" BSP
- Test Points** 1/4" BSP
- Valve Fixings** M5 x 12  
Full Thread
- Manifold Fixings** 6.8 Dia Through  
C'Bore 11 Dia x 9 dp
- Pitch** 54.0mm

SIDE ENTRY TEST POINT • CETOP 3					
ORDER CODE	NUMBER OF STATIONS	OVERALL LENGTH	OVERALL WEIGHT	NETT. PRICE	
				£ STERLING	€ EUROS
125161/1	ONE	92.0	6.7 Kgs	£169.73	€ 229.14
125161/2	TWO	146.0	10.7 Kgs	£256.28	€ 345.99
125161/3	THREE	200.0	14.6 Kgs	£342.44	€ 462.28
125161/4	FOUR	254.0	18.6 Kgs	£429.95	€ 580.42
125161/5	FIVE	308.0	22.5 Kgs	£516.88	€ 697.79
125161/6	SIX	362.0	26.5 Kgs	£606.28	€ 818.48
125161/7	SEVEN	416.0	30.5 Kgs	£696.82	€ 940.71
125161/8	EIGHT	416.0	34.5 Kgs	£786.00	€ 1,061.10

# FLOWFIT SIDE ENTRY RELIEF VALVE CETOP 3



www.flowfitonline.com  
TECH. DATA SHEET  
**FCV4**

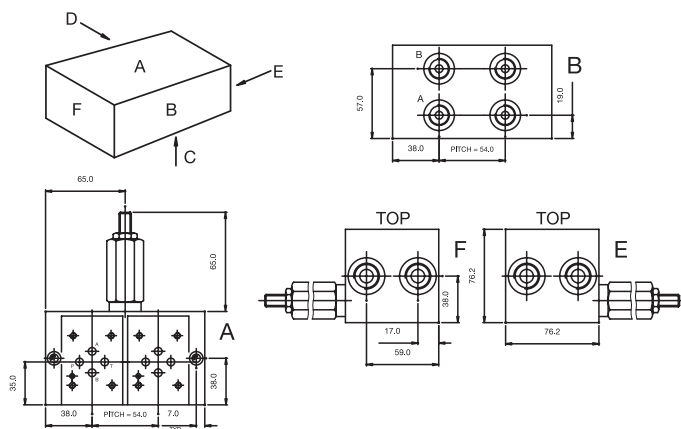

### ORDERING CODE INFORMATION

- Steel** Code No. 115161/★  
Alum. Alloy  
Available on request  
★ = Number of stations
- Material** Steel  
Alum. Alloy
- Working Pressure** Steel 315 Bar  
Alum. Alloy 250 Bar
- 'A' and 'B' Ports** 3/8" BSP  
**'P' and 'T' Ports** 1/2" BSP
- Valve Fixings** M5 x 12  
Full Thread
- Manifold Fixings** 6.8 Dia Through  
C'Bore 11 Dia x 9 dp
- Adjustable Press.** 5 to 420 Bar Range
- Pitch** 54.0mm

SIDE ENTRY RELIEF VALVE • CETOP 3					
ORDER CODE	NUMBER OF STATIONS	OVERALL LENGTH	OVERALL WEIGHT	NETT. PRICE	
				£ STERLING	€ EUROS
115161/1	ONE	105.0	4.1 Kgs	£233.73	€ 315.53
115161/2	TWO	130.0	5.3 Kgs	£251.16	€ 339.08
115161/3	THREE	184.0	7.6 Kgs	£301.29	€ 406.75
115161/4	FOUR	238.0	10.0 Kgs	£337.62	€ 455.78
115161/5	FIVE	292.0	12.2 Kgs	£384.32	€ 518.82
115161/6	SIX	346.0	14.5 Kgs	£430.96	€ 581.81
115161/7	SEVEN	400.0	16.8 Kgs	£483.43	€ 652.62
115161/8	EIGHT	454.0	19.1 Kgs	£534.32	€ 721.33

## FLOWFIT CETOP 3 NG6 STEEL SUBPLATE WITH SIDE PORTS

www.flowfitonline.com  
TECH. DATA SHEET  
**FCV15**



The Flowfit CETOP 3 subplate is machined from steel and is available with 3/8" BSP, 1/2" BSP or 3/4" BSP side ports.

PRODUCT REFERENCE	DESCRIPTION	NETT. PRICE	
		£ STERLING	€ EUROS
D-03-SP-S-6G	CETOP 3 SUBPLATE SIDE ENTRY 3/8" BSPP PORTED	£17.52	€ 23.65
D-03-SP-S-8G	CETOP 3 SUBPLATE SIDE ENTRY 1/2" BSPP PORTED	£19.25	€ 25.97
D-03-SP-S-12G	CETOP 3 SUBPLATE SIDE ENTRY 3/4" BSPP PORTED	£29.99	€ 40.49

## FLOWFIT CETOP 3 NG6 STEEL SUBPLATE WITH BASE PORTS

www.flowfitonline.com  
TECH. DATA SHEET  
**FCV16**



The Flowfit CETOP 3 subplate is machined from steel and is available with 3/8" BSP, 1/2" BSP or 3/4" BSP base ports.

PRODUCT REFERENCE	DESCRIPTION	NETT. PRICE	
		£ STERLING	€ EUROS
D-03-SP-B-6G	CETOP 3 SUBPLATE BASE ENTRY 3/8" BSPP PORTED	£17.52	€ 23.65
D-03-SP-B-8G	CETOP 3 SUBPLATE BASE ENTRY 1/2" BSPP PORTED	£19.25	€ 25.97
D-03-SP-B-12G	CETOP 3 SUBPLATE BASE ENTRY 3/4" BSPP PORTED	£29.99	€ 40.49
DSGM-02-032-B25-BSPP	CETOP 3 3/8" P+T BOTTOM, A + B SIDE	£33.69	€ 45.47

## FLOWFIT CETOP 3 NG6 STEEL COVER PLATE

www.flowfitonline.com  
TECH. DATA SHEET  
**FCV17**

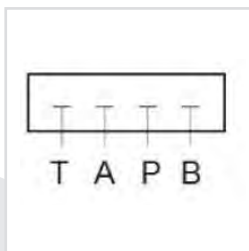

The Flowfit steel cover plate replaces a CETOP 3 solenoid valve on the steel manifold, providing a pressure blank to enable the remaining stations to operate.



PRODUCT REFERENCE	DESCRIPTION	NETT. PRICE	
		£ STERLING	€ EUROS
D-03-CP-G	CETOP 3 COVER PLATE	£5.50	€ 7.42

# FLOWFIT CETOP 5 NG10 SOLENOID DIRECTIONAL CONTROL VALVE

www.flowfitonline.com  
TECH. DATA SHEET  
**FCV18**

Flowfit offer a large range of solenoid operated CETOP 5 NG10 with a maximum flow of 120 l/min, commonly used in powerpacks and other hydraulic applications. Available in 12VDC, 24VDC, 110VAC and 220VAC.

Flowfit F5-03 series CETOP 5 NG10 solenoid valves are Electro-Hydraulic spool type valves. They are solenoid operated and control the start, stop and direction of the oil flow in the hydraulic circuit.

They are used for hydraulic powerpacks as well as for stand alone hydraulic manifold blocks.

### SPECIFICATION

- Nominal Size:** NG10
- Maximum Flow Rate:** 120 l/min
- Maximum Pressure:** A,B,P = 315 Bar
- Seal Material:-** NBR
- Max Fluid Temperature:** -20° to 70°C
- Oil Viscosity:** -2.8 to 380 mm<sup>2</sup>/s
- Switch Cycles** Open: 50 ~ 60ms  
Closed: 50 ~ 70ms
- Switch Frequency:** 15000 times per hour
- Insulation Grade:** IP65
- Weight:** Single Solenoid: 4.8kg,  
Double Solenoid: 6.1kg
- Voltages:** 12VDC=D1, 24VDC=D2, 1  
10V/AC 50HZ=A1,  
220V/AC 50HZ=A2
- Manual Override:** Standard on all valves
- Connector Type:** DIN Plug (with LED)

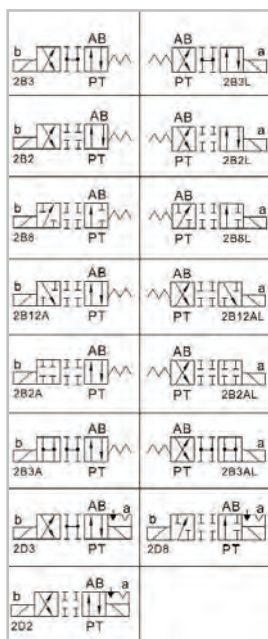

### FLOWFIT CETOP 5 NG10 SPRING CENTERED 3 POSITION DOUBLE ACTING SOLENOID DIRECTIONAL CONTROL VALVE

PRODUCT REFERENCE	DOUBLE SOLENOID	CONFIGURATION	SPOOL RETURN	NETT. PRICE	
				£ STERLING	€ EUROS
F5-03-3C2-**	Double	3 Position	Spring	£93.47	€ 126.19
F5-03-3C3-**	Double	3 Position	Spring	£93.47	€ 126.19
F5-03-3C4-**	Double	3 Position	Spring	£93.47	€ 126.19
F5-03-3C5-**	Double	3 Position	Spring	£93.47	€ 126.19
F5-03-3C9-**	Double	3 Position	Spring	£93.47	€ 126.19
F5-03-3C10-**	Double	3 Position	Spring	£93.47	€ 126.19
F5-03-3C11-**	Double	3 Position	Spring	£93.47	€ 126.19
F5-03-3C12-**	Double	3 Position	Spring	£93.47	€ 126.19
F5-03-3C25-**	Double	3 Position	Spring	£93.47	€ 126.19
F5-03-3C40-**	Double	3 Position	Spring	£93.47	€ 126.19
F5-03-3C60-**	Double	3 Position	Spring	£93.47	€ 126.19

**NOTE: SUBSTITUTE THE \*\* WITH VOLTAGE PREFERENCE. 12VDC=D1, 24VDC=D2, 110V/AC 50HZ=A1, 220V/AC 50HZ=A2**

### SPRING OFFSET 2 POSITION SOLENOID DIRECTIONAL CONTROL VALVE

PRODUCT REFERENCE	SINGLE SOLENOID	CONFIGURATION	SPOOL RETURN	NETT. PRICE	
				£ STERLING	€ EUROS
F5-03-2B2-**	Single	2 Position	Spring	£93.47	€ 126.19
F5-03-2B2L-**	Single	2 Position	Spring	£61.02	€ 82.38
F5-03-2B2A-**	Single	2 Position	Spring	£61.02	€ 82.38
F5-03-2B2AL-**	Single	2 Position	Spring	£61.02	€ 82.38
F5-03-2B2B-**	Single	2 Position	Spring	£61.02	€ 82.38
F5-03-2B2BL-**	Single	2 Position	Spring	£61.02	€ 82.38
F5-03-2B3-**	Single	2 Position	Spring	£61.02	€ 82.38
F5-03-2B3L-**	Single	2 Position	Spring	£61.02	€ 82.38
F5-03-2B3A-**	Single	2 Position	Spring	£61.02	€ 82.38
F5-03-2B3AL-**	Single	2 Position	Spring	£61.02	€ 82.38
F5-03-2B3B-**	Single	2 Position	Spring	£61.02	€ 82.38
F5-03-2B3BL-**	Single	2 Position	Spring	£61.02	€ 82.38
F5-03-2B4-**	Single	2 Position	Spring	£61.02	€ 82.38
F5-03-2B4BL-**	Single	2 Position	Spring	£61.02	€ 82.38
F5-03-2B5-**	Single	2 Position	Spring	£61.02	€ 82.38
F5-03-2B5BL-**	Single	2 Position	Spring	£61.02	€ 82.38
F5-03-2B8-**	Single	2 Position	Spring	£61.02	€ 82.38
F5-03-2B8L-**	Single	2 Position	Spring	£61.02	€ 82.38
F5-03-2B9B-**	Single	2 Position	Spring	£61.02	€ 82.38
F5-03-2B9BL-**	Single	2 Position	Spring	£61.02	€ 82.38
F5-03-2B10B-**	Single	2 Position	Spring	£61.02	€ 82.38
F5-03-2B10BL-**	Single	2 Position	Spring	£61.02	€ 82.38
F5-03-2B11B-**	Single	2 Position	Spring	£61.02	€ 82.38
F5-03-2B11BL-**	Single	2 Position	Spring	£61.02	€ 82.38
F5-03-2B12A-**	Single	2 Position	Spring	£61.02	€ 82.38
F5-03-2B12AL-**	Single	2 Position	Spring	£61.02	€ 82.38
F5-03-2B12B-**	Single	2 Position	Spring	£61.02	€ 82.38

### SPRING CENTERED 2 POSITION SOLENOID DIRECTIONAL CONTROL VALVE

PRODUCT REFERENCE	SINGLE SOLENOID	CONFIGURATION	SPOOL RETURN	NETT. PRICE	
				£ STERLING	€ EUROS
F5-03-2B12BL-**	Single	2 Position	Spring	£61.02	€ 82.38
F5-03-2B25B-**	Single	2 Position	Spring	£61.02	€ 82.38
F5-03-2B25BL-**	Single	2 Position	Spring	£61.02	€ 82.38
F5-03-2B40B-**	Single	2 Position	Spring	£61.02	€ 82.38
F5-03-2B40BL-**	Single	2 Position	Spring	£61.02	€ 82.38
F5-03-2B60B-**	Single	2 Position	Spring	£61.02	€ 82.38
F5-03-2B60BL-**	Single	2 Position	Spring	£61.02	€ 82.38

**NOTE: SUBSTITUTE THE \*\* WITH VOLTAGE PREFERENCE.12VDC=D1, 24VDC=D2, 110V/AC 50HZ=A1, 220V/AC 50HZ=A2**

## FLOWFIT CETOP 5 HAND OPERATED DIRECTIONAL CONTROL VALVES

www.flowfitonline.com  
TECH. DATA SHEET  
**FCV19**



MAXIMUM FLOW: 50 l/min  
MAXIMUM PRESSURE: 250 Bar

SEE SPOOL CONFIGURATIONS ON PREVIOUS PAGE

SUBPLATE	SPRING CENTRED	DETENT	PRICE	
			£ STERLING	€ EUROS
DMG-03-*	W	*****	£160.70	€ 216.94
DMG-03-*	*****	O	£171.84	€ 231.97

# FLOWFIT CETOP 5 NG10 MODULAR RELIEF VALVE

www.flowfitonline.com  
TECH. DATA SHEET  
**FCV20**

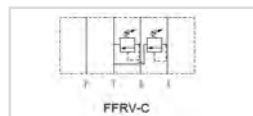
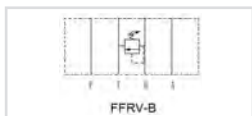
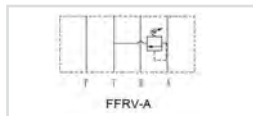
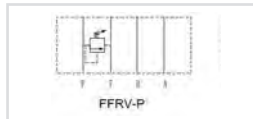

The Flowfit CETOP 5 NG10 Modular Relief Valve is available in a variety of configurations to control pressure in either the P, A or B ports.

There are three pressure ranges to choose from, providing the versatility to control system pressure in any application.

Pressure can be adjusted using the plastic knob (standard on all modular relief valves) but for added security, valves can also be supplied with an adjustment screw that can be locked once pressure has been set (Available upon request).

The pressure ranges available are:

- 8 - 70bar
- 35 - 140bar
- 70 - 250bar

**SPECIFICATION**

- Nominal Size:** NG10
- Maximum Flow Rate:** 70 l/min
- Maximum Pressure:** 250 Bar
- Seal Material:**- NBR
- Max Fluid Temperature:** -20° to 70°C
- Oil Viscosity:** -2.8 to 380 mm2/s
- Weight** P, A, B: 3.3kg
- C: 3.7kg
- Manual Adjustment:** Standard on all valves

PRODUCT REFERENCE	DESCRIPTION	NETT. PRICE	
		£ STERLING	€ EUROS
FFRV-03P-K-1-20	CETOP 5 MODULAR RELIEF VALVE 8-70BAR ON P	£60.36	€ 81.49
FFRV-03P-K-2-20	CETOP 5 MODULAR RELIEF VALVE 35-140BAR ON P	£60.36	€ 81.49
FFRV-03P-K-3-20	CETOP 5 MODULAR RELIEF VALVE 70-250BAR ON P	£60.36	€ 81.49
FFRV-03A-K-1-20	CETOP 5 MODULAR RELIEF VALVE 8-70BAR ON A	£60.36	€ 81.49
FFRV-03A-K-2-20	CETOP 5 MODULAR RELIEF VALVE 35-140BAR ON A	£60.36	€ 81.49
FFRV-03A-K-3-20	CETOP 5 MODULAR RELIEF VALVE 70-250BAR ON A	£69.98	€ 94.48
FFRV-03B-K-1-20	CETOP 5 MODULAR RELIEF VALVE 8-70BAR ON B	£60.36	€ 81.49
FFRV-03B-K-2-20	CETOP 5 MODULAR RELIEF VALVE 35-140BAR ON B	£60.36	€ 81.49
FFRV-03B-K-3-20	CETOP 5 MODULAR RELIEF VALVE 70-250BAR ON B	£69.98	€ 94.48
FFRV-03C-K-1-20	CETOP 5 MODULAR RELIEF VALVE 8-70BAR ON A+B	£77.89	€ 105.15
FFRV-03C-K-2-20	CETOP 5 MODULAR RELIEF VALVE 35-140BAR ON A+B	£84.13	€ 113.58
FFRV-03C-K-3-20	CETOP 5 MODULAR RELIEF VALVE 70-250BAR ON A+B	£77.89	€ 105.15

# FLOWFIT CETOP 5 NG10 MODULAR REDUCING VALVE

www.flowfitonline.com  
TECH. DATA SHEET  
**FCV21**

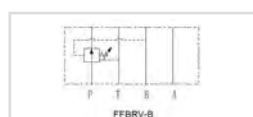
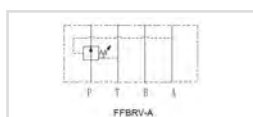
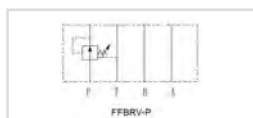

The Flowfit modular reducing valve is designed to lower the pressure in a specific circuit compared to the main system pressure.

There are three pressure ranges to choose from, providing the versatility to control individual circuit pressure.

Pressure can be adjusted using the plastic knob (standard on all modular reducing valves) but for added security, valves can also be supplied with an adjustment screw that can be locked once pressure has been set (Available upon request).

The pressure ranges available are:

- 8 - 70bar
- 35 - 140bar
- 70 - 250bar

**SPECIFICATION**

- Nominal Size:** NG10
- Maximum Flow Rate:** 70 l/min
- Maximum Pressure:** 250 Bar
- Seal Material:**- NBR
- Max Fluid Temperature:** -20° to 70°C
- Oil Viscosity:** -2.8 to 380 mm2/s
- Weight:** 3.3kg
- Manual Adjustment:** Standard on all valves

PRODUCT REFERENCE	DESCRIPTION	NETT. PRICE	
		£ STERLING	€ EUROS
FFBRV-03P-K-1-20	CETOP 5 MODULAR REDUCING VALVE 8-70BAR ON P	£60.36	€ 81.49
FFBRV-03P-K-2-20	CETOP 5 MODULAR REDUCING VALVE 35-140BAR ON P	£60.36	€ 81.49
FFBRV-03P-K-3-20	CETOP 5 MODULAR REDUCING VALVE 70-250BAR ON P	£60.36	€ 81.49
FFBRV-03A-K-1-20	CETOP 5 MODULAR REDUCING VALVE 8-70BAR ON A	£60.36	€ 81.49
FFBRV-03A-K-2-20	CETOP 5 MODULAR REDUCING VALVE 35-140BAR ON A	£60.36	€ 81.49
FFBRV-03A-K-3-20	CETOP 5 MODULAR REDUCING VALVE 70-250BAR ON A	£60.36	€ 81.49
FFBRV-03B-K-1-20	CETOP 5 MODULAR REDUCING VALVE 8-70BAR ON B	£60.36	€ 81.49
FFBRV-03B-K-2-20	CETOP 5 MODULAR REDUCING VALVE 35-140BAR ON B	£60.36	€ 81.49
FFBRV-03B-K-3-20	CETOP 5 MODULAR REDUCING VALVE 70-250BAR ON B	£60.36	€ 81.49

## FLOWFIT CETOP 5 NG10 MODULAR CHECK VALVE

www.flowfitonline.com  
TECH. DATA SHEET  
**FCV22**

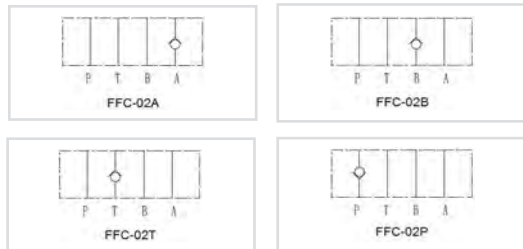

The Flowfit modular check valve allows free flow in one direction and blocks the flow in the opposite direction.

Flowfit check valves are available for the A, B, P or T port and can be specified with a cracking pressure of 0.35bar or 3.5bar depending on the system requirements.

### SPECIFICATION

**Nominal Size:** NG10  
**Maximum Flow Rate:** 70 l/min  
**Maximum Pressure:** 250 Bar  
**Seal Material:** NBR  
**Max Fluid Temperature:** -20° to 70°C  
**Oil Viscosity:** -2.8 to 380 mm<sup>2</sup>/s  
**Weight:** 2.5kg



PRODUCT REFERENCE	DESCRIPTION	NETT. PRICE	
		£ STERLING	€ EUROS
FFC-03P-05-20	CETOP 5 MODULAR CHECK VALVE C/P 0.35BAR ON P	£54.52	€ 73.60
FFC-03P-50-20	CETOP 5 MODULAR CHECK VALVE C/P 3.5BAR ON P	£54.52	€ 73.60
FFC-03A-05-20	CETOP 5 MODULAR CHECK VALVE C/P 0.35BAR ON A	£54.52	€ 73.60
FFC-03A-50-20	CETOP 5 MODULAR CHECK VALVE C/P 3.5BAR ON A	£54.52	€ 73.60
FFC-03B-05-20	CETOP 5 MODULAR CHECK VALVE C/P 0.35BAR ON B	£54.52	€ 73.60
FFC-03B-50-20	CETOP 5 MODULAR CHECK VALVE C/P 3.5BAR ON B	£54.52	€ 73.60
FFC-03T-05-20	CETOP 5 MODULAR CHECK VALVE C/P 0.35BAR ON T	£54.52	€ 73.60
FFC-03T-50-20	CETOP 5 MODULAR CHECK VALVE C/P 3.5BAR ON T	£54.52	€ 73.60

## FLOWFIT CETOP 5 NG10 MODULAR PILOT OPERATED CHECK VALVE

www.flowfitonline.com  
TECH. DATA SHEET  
**FCV23**

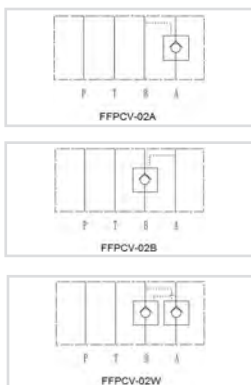

The Flowfit modular pilot operated (P/O) check valve allows free flow in one direction and pilot pressure allows flow in the opposite direction.

Flowfit pilot operated check valves are available for the A or B ports individually, or the A and B ports combined. They can be specified with a cracking pressure of 0.35bar or 3.5bar depending on the system requirements

### SPECIFICATION

**Nominal Size:** NG10  
**Maximum Flow Rate:** 70 l/min  
**Maximum Pressure:** 250 Bar  
**Seal Material:** NBR  
**Max Fluid Temperature:** -20° to 70°C  
**Oil Viscosity:** -2.8 to 380 mm<sup>2</sup>/s  
**Weight:** 2.6kg

PRODUCT REFERENCE	DESCRIPTION	NETT. PRIC	
		£ STERLING	€ EUROS
FFPCV-03A-05-20	CETOP 5 MODULAR P/O CHECK VALVE C/P 0.35BAR ON A	£84.13	€ 113.57
FFPCV-03A-50-20	CETOP 5 MODULAR P/O CHECK VALVE C/P 3.5BAR ON A	£84.13	€ 113.57
FFPCV-03B-05-20	CETOP 5 MODULAR P/O CHECK VALVE C/P 0.35BAR ON B	£84.13	€ 113.57
FFPCV-03B-50-20	CETOP 5 MODULAR P/O CHECK VALVE C/P 3.5BAR ON B	£84.13	€ 113.57
FFPCV-03W-05-20	CETOP 5 MODULAR P/O CHECK VALVE C/P 0.35BAR ON A & B	£103.60	€ 139.86
FFPCV-03W-50-20	CETOP 5 MODULAR P/O CHECK VALVE C/P 3.5BAR ON A & B	£103.60	€ 139.86

## FLOWFIT CETOP 5 COUNTER BALANCE VALVE

www.flowfitonline.com  
TECH. DATA SHEET  
**FCV24**

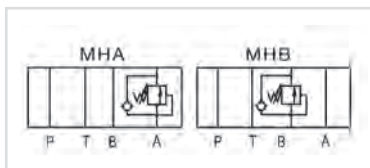

CODE	NETT. PRICE	
	£ STERLING	€ EUROS
MHA-03-★	£142.83	€ 192.81
MHB-03-★	£142.83	€ 192.81
Pressure Ranges B = 8 - 70 Bar, H = 20 - 250 Bar		
Max. Flow 03 = 80 l/m • ★ = Pressure Range		

## FLOWFIT CETOP 5 SEQUENCE VALVES

www.flowfitonline.com  
TECH. DATA SHEET  
**FCV25**

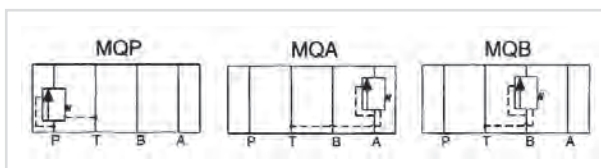

CODE	DESCRIPTION	NETT. PRICE	
		£ STERLING	€ EUROS
MQP-03-★	CETOP 5 SEQUENCE VALVE ON P PORT	£187.48	€ 253.09
MQA-03-★	CETOP 5 SEQUENCE VALVE ON A PORT	£187.48	€ 253.09
MQB-03-★	CETOP 5 SEQUENCE VALVE ON B PORT	£187.48	€ 253.09
Pressure Ranges B = 8 - 70 Bar, C = 35 - 140 Bar, H = 105 - 250 Bar			
Max. Flow 03 = 80 l/m • ★ = Pressure Range			

## FLOWFIT CETOP 5 NG10 MODULAR FLOW CONTROL VALVE WITH CHECK

www.flowfitonline.com  
TECH. DATA SHEET  
**FCV26**

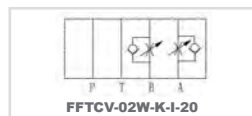
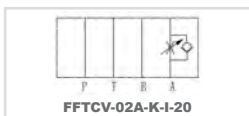
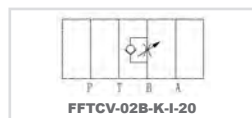
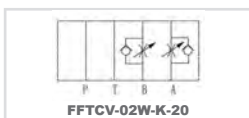
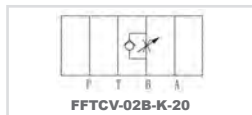
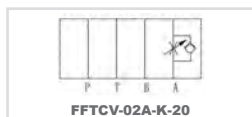

The Flowfit modular flow control valves regulate the flow of oil through the circuit in one direction whilst allowing free flow in the opposite direction using a check valve.

Two types of valve are available; the first meters the flow of oil into the circuit (allowing free flow out), while the second meters the flow out of the circuit (allowing free flow in).

Flow on the metered side can be adjusted using the plastic knob (standard on all modular flow control valves) but for added security, valves can also be supplied with an adjustment screw that can be locked once the desired flow has been set (Available upon request).

**SPECIFICATION**

- Nominal Size: NG6
- Maximum Flow Rate: 70 l/min
- Maximum Pressure: 250 Bar
- Seal Material: - NBR
- Max Fluid Temperature: -20° to 70°C
- Oil Viscosity: -2.8 to 380 mm<sup>2</sup>/s
- Weight: A, B 2.6kg  
W 2.8kg
- Manual Adjustment: Standard on all valves

PRODUCT REFERENCE	DESCRIPTION	NETT. PRICE	
		£ STERLING	€ EUROS
FFTCV-03A-K-20	CETOP 5 MODULAR FLOW CONTROL VALVE MTR OUT ON A PORT	£60.36	€ 81.49
FFTCV-03A-K-I-20	CETOP 5 MODULAR LFLOW CONTROL VALVE MTR IN ON A PORT	£60.36	€ 81.49
FFTCV-03B-K-20	CETOP 5 MODULAR FLOW CONTROL VALVE MTR OUT ON B PORT	£60.36	€ 81.49
FFTCV-03B-K-I-20	CETOP 5 MODULAR LFLOW CONTROL VALVE MTR IN ON B PORT	£60.36	€ 81.49
FFTCV-03W-K-20	CETOP 5 MODULAR FLOW CONTROL VALVE MTR OUT ON A & B PORT	£64.26	€ 86.76
FFTCV-03W-K-I-20	CETOP 5 MODULAR LFLOW CONTROL VALVE MTR IN ON A & B PORT	£64.26	€ 86.76

## FLOWFIT CETOP 5 NG10 STEEL PARALLEL CIRCUIT MANIFOLD

www.flowfitonline.com  
TECH. DATA SHEET  
**FCV27**

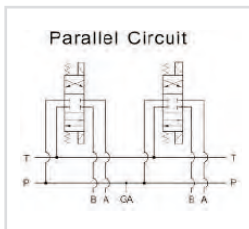

The Flowfit CETOP 5 parallel circuit manifold is precision machined from a mild steel block with sizes of 1/2" BSP for A & B ports and 3/4" BSP for P & T ports.

Flowfit manifolds are available from 1 to 10 stations with a 1/4" BSP Gauge port machined as standard on the 2 station and above (not available on the 1 station manifold).

PRODUCT REFERENCE	DESCRIPTION	NETT. PRICE	
		£ STERLING	€ EUROS
MD-05P-1-G	CETOP 5 1 STATION STEEL MANIFOLD NO RV CAVITY	£42.84	€ 57.83
MD-05P-2-G	CETOP 5 2 STATION STEEL MANIFOLD NO RV CAVITY	£85.69	€ 115.68
MD-05P-3-G	CETOP 5 3 STATION STEEL MANIFOLD NO RV CAVITY	£132.42	€ 178.76
MD-05P-4-G	CETOP 5 4 STATION STEEL MANIFOLD NO RV CAVITY	£177.21	€ 239.23
MD-05P-5-G	CETOP 5 5 STATION STEEL MANIFOLD NO RV CAVITY	£221.99	€ 299.69
MD-05P-6-G	CETOP 5 6 STATION STEEL MANIFOLD NO RV CAVITY	£270.67	€ 365.41
MD-05P-7-G	CETOP 5 7 STATION STEEL MANIFOLD NO RV CAVITY	£319.36	€ 431.14
MD-05P-8-G	CETOP 5 8 STATION STEEL MANIFOLD NO RV CAVITY	£369.99	€ 499.49
MD-05P-9-G	CETOP 5 9 STATION STEEL MANIFOLD NO RV CAVITY	£418.67	€ 565.21
MD-05P-10-G	CETOP 5 10 STATION STEEL MANIFOLD NO RV CAVITY	£469.30	€ 633.56

## FLOWFIT SIDE ENTRY CETOP 5



www.flowfitonline.com  
TECH. DATA SHEET  
**FCV28**

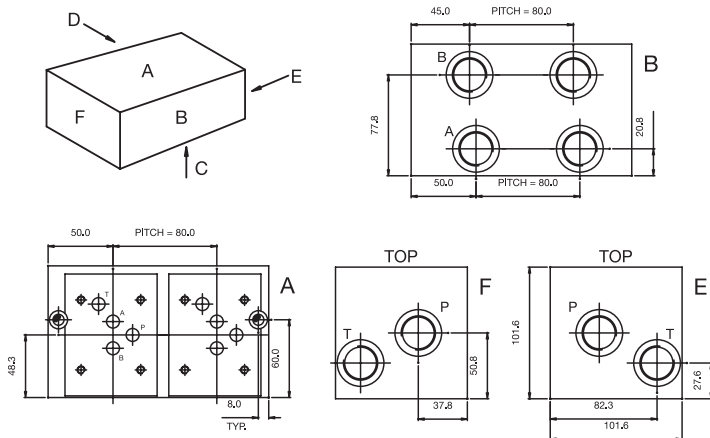

### ORDERING CODE INFORMATION

- Steel** Code No. 205171/★  
Alum. Alloy Available on request  
★ = Number of stations
- Material** Steel  
Alum. Alloy
- Working Pressure** Steel 315 Bar  
Alum. Alloy 250 Bar
- 'A' and 'B' Ports** 3/4" BSP
- 'P' and 'T' Ports** 3/4" BSP
- Valve Fixings** M6 x 12 Full Thread
- Manifold Fixings** 8.5 Dia Through  
C'Bore 11 Dia x 9 dp
- Pitch** 80.0mm

### SIDE ENTRY • CETOP 5

ORDER CODE	NUMBER OF STATIONS	OVERALL LENGTH	OVERALL WEIGHT	PRICE	
				£ STERLING	€ EUROS
205171/1	ONE	90.0	7.0 Kgs	£130.59	€ 176.30
205171/2	TWO	170.0	12.5 Kgs	£178.90	€ 241.51
205171/3	THREE	250.0	18.0 Kgs	£236.75	€ 319.60
205171/4	FOUR	330.0	24.0 Kgs	£305.29	€ 412.15
205171/5	FIVE	410.0	30.0 Kgs	£375.28	€ 506.62
205171/6	SIX	490.0	36.0 Kgs	£454.67	€ 613.80



# FLOWFIT SIDE ENTRY TEST POINT CETOP 5



www.flowfitonline.com  
TECH. DATA SHEET  
**FCV29**

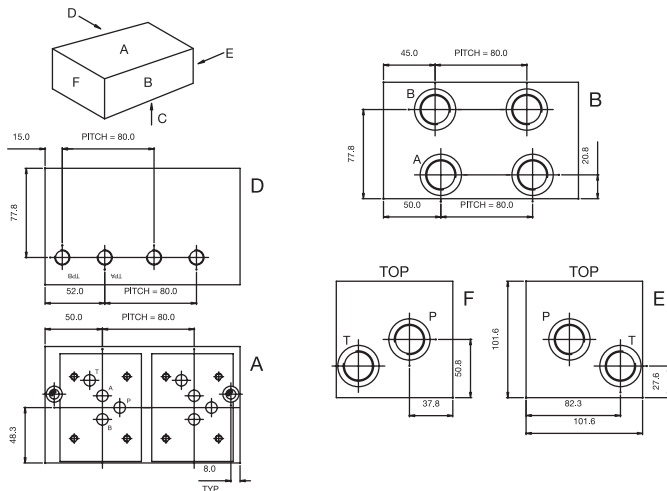

### ORDERING CODE INFORMATION

- Steel** Code No. 225171/★  
Alum. Alloy Available on request  
★ = Number of stations
- Material** Steel  
Alum. Alloy
- Working Pressure** Steel 315 Bar  
Alum. Alloy 250 Bar
- 'A' and 'B' Ports** 3/4" BSP  
**'P' and 'T' Ports** 3/4" BSP
- Test Points** 1/4" BSP
- Valve Fixings** M6 x 12 Full Thread
- Manifold Fixings** 8.5 Dia Through  
C'Bore 11 Dia x 9 dp
- Pitch** 80.0mm

### SIDE ENTRY TEST POINT • CETOP 5

ORDER CODE	NUMBER OF STATIONS	OVERALL LENGTH	OVERALL WEIGHT	NETT. PRICE	
				£ STERLING	€ EUROS
225171/1	ONE	90.0	7.0 Kgs	£181.40	€ 244.88
225171/2	TWO	170.0	12.5 Kgs	£280.42	€ 378.57
225171/3	THREE	250.0	18.0 Kgs	£391.95	€ 529.14
225171/4	FOUR	330.0	24.0 Kgs	£511.65	€ 690.72
225171/5	FIVE	410.0	30.0 Kgs	£631.41	€ 852.40
225171/6	SIX	490.0	36.0 Kgs	£763.75	€ 1,031.07

# FLOWFIT SIDE ENTRY RELIEF VALVE CETOP 5



www.flowfitonline.com  
TECH. DATA SHEET  
**FCV30**

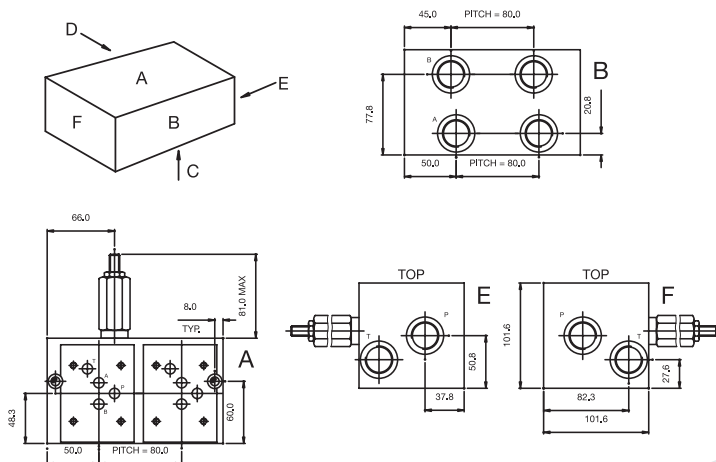

### ORDERING CODE INFORMATION

- Steel** Code No. 215171/★  
Alum. Alloy Available on request  
★ = Number of stations
- Material** Steel  
Alum. Alloy
- Working Pressure** Steel 315 Bar  
Alum. Alloy 250 Bar
- 'A' and 'B' Ports** 3/4" BSP  
**'P' and 'T' Ports** 3/4" BSP
- Valve Fixings** M6 x 12 Full Thread
- Manifold Fixings** 8.5 Dia Through  
C'Bore 11 Dia x 9 dp
- Adjustable Press.** 5 to 420 Bar Range
- Pitch** 80.0mm

### SIDE ENTRY RELIEF VALVE • CETOP 5

ORDER CODE	NUMBER OF STATIONS	OVERALL LENGTH	OVERALL WEIGHT	NETT. PRICE	
				£ STERLING	€ EUROS
215171/1	ONE	90.0	7.0 Kgs	£352.16	€ 475.41
215171/2	TWO	170.0	12.5 Kgs	£377.54	€ 509.66
215171/3	THREE	250.0	18.0 Kgs	£432.65	€ 584.06
215171/4	FOUR	330.0	24.0 Kgs	£497.69	€ 671.88
215171/5	FIVE	410.0	30.0 Kgs	£562.73	€ 759.69
215171/6	SIX	490.0	36.0 Kgs	£637.53	€ 860.67

## FLOWFIT CETOP 5 NG10 STEEL PARALLEL CIRCUIT MANIFOLD WITH RELIEF VALVE CAVITY

www.flowfitonline.com  
TECH. DATA SHEET  
**FCV31**

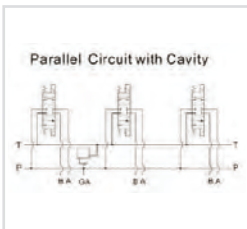

The Flowfit CETOP 5 parallel circuit manifold is precision machined from a steel block with sizes of 3/8" BSP for A & B ports and 1/2" BSP for P & T ports. The manifold also comes with a machined port for a relief valve (available separately).

Flowfit manifolds are available from 1 to 10 stations with a 1/4" BSP Gauge port machined as standard on the 2 station and above (not available on the 1 station manifold).

PRODUCT REFERENCE	DESCRIPTION	NETT. PRICE	
		£ STERLING	€ EUROS
MD-05P-1-G-M32	CETOP 5 1 STATION STEEL MANIFOLD WITH RV CAVITY	£79.34	€ 107.10
MD-05P-2-G-M32	CETOP 5 2 STATION STEEL MANIFOLD WITH RV CAVITY	£106.79	€ 144.17
MD-05P-3-G-M32	CETOP 5 3 STATION STEEL MANIFOLD WITH RV CAVITY	£151.62	€ 204.68
MD-05P-4-G-M32	CETOP 5 4 STATION STEEL MANIFOLD WITH RV CAVITY	£197.46	€ 266.57
MD-05P-5-G-M32	CETOP 5 5 STATION STEEL MANIFOLD WITH RV CAVITY	£244.30	€ 329.80
MD-05P-6-G-M32	CETOP 5 6 STATION STEEL MANIFOLD WITH RV CAVITY	£292.14	€ 394.39
MD-05P-7-G-M32	CETOP 5 7 STATION STEEL MANIFOLD WITH RV CAVITY	£341.02	€ 460.37
MD-05P-8-G-M32	CETOP 5 8 STATION STEEL MANIFOLD WITH RV CAVITY	£390.87	€ 527.69
MD-05P-9-G-M32	CETOP 5 9 STATION STEEL MANIFOLD WITH RV CAVITY	£441.75	€ 596.37
MD-05P-10-G-M32	CETOP 5 10 STATION STEEL MANIFOLD WITH RV CAVITY	£493.64	€ 666.40
VC1200/400	CETOP 5 RELIEF VALVE CARTRIDGE ONLY	£40.36	€ 54.49

**NOTE**  
VC1200/400 Cetop 5 Relief Valve Cartridge needs to be purchased when ordering 'Cetop 5 NG10 Steel Parallel Circuit Manifold with Relief Valve Cavity'.

## FLOWFIT CETOP 5 NG10 STEEL SUBPLATE WITH SIDE PORTS

www.flowfitonline.com  
TECH. DATA SHEET  
**FCV32**



The Flowfit CETOP 5 subplate is machined from steel and comes with 1/2" BSP side ports.



PRODUCT REFERENCE	DESCRIPTION	NETT. PRICE	
		£ STERLING	€ EUROS
D-05-SP-S-8G	CETOP 5 SUBPLATE SIDE ENTRY 1/2" BSPP PORTED	£25.97	€ 35.06

## FLOWFIT CETOP 5 NG10 STEEL SUBPLATE WITH BASE PORTS

www.flowfitonline.com  
TECH. DATA SHEET  
**FCV33**



The Flowfit CETOP 5 subplate is machined from steel and comes with 1/2" BSP base ports.

PRODUCT REFERENCE	DESCRIPTION	NETT. PRICE	
		£ STERLING	€ EUROS
D-05-SP-B-8G	CETOP 5 SUBPLATE BASE ENTRY 1/2" BSPP PORTED	£25.97	€ 35.06
DSGM-03-04-2B25-BSPP	CETOP 5 SUBPLATE BASE ENTRY 1/2" BSP P+T, A + B SIDE	£55.11	€ 74.40

# FLOWFIT CETOP 5 NG10 STEEL COVER PLATE

www.flowfitonline.com  
TECH. DATA SHEET  
**FCV34**

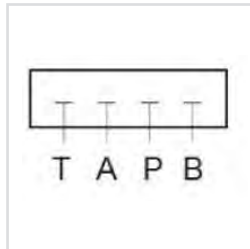

The Flowfit steel cover plate replaces a CETOP 5 solenoid valve on the steel manifold, providing a pressure blank to enable the remaining stations to operate.

PRODUCT REFERENCE	DESCRIPTION	NETT. PRICE	
		£ STERLING	€ EUROS
D-05-CP-G	CETOP 5 COVER PLATE	£9.54	€ 12.87

# FLOWFIT CETOP 7 NG16 SOLENOID PILOT OPERATED DIRECTIONAL CONTROL VALVES

www.flowfitonline.com  
TECH. DATA SHEET  
**FCV35**



Flowfit offer a large range of solenoid pilot operated directional control valves.

The spool is controlled to shift flow direction of system by piloted pressure sent from a NG6/Cetop 3 solenoid directional control valve mounted on top of the main valve. This NG6/Cetop 3 valve is a double acting spool type 3C4.

This Cetop 3 valve solenoid controls the pilot flow on the main deck valve which will then control higher pressures and larger flows.

### SPECIFICATION

- Nominal Size: NG6 Cetop 7
- Rated Flow: 200 l/min
- Max Flow: 300 l/min
- Max Operating Pressure: 250 Bar
- Max Pressure A, B, P Port: 315 Bar
- Min Pilot Pressure: 8 Bar
- Max Pilot Pressure: 210 Bar
- Max Operating Frequency: 120 CPM
- Weight: 8.8kg
- Max Working Pressure 'T' Port External Drain: 250 Bar
- Max Working Pressure 'T' Port Internal Drain: 160 Bar DC / 100 Bar AC
- Max Working Pressure 'Y' Port External Drain: 160 Bar DC / 100 Bar AC

THESE VALVES ARE THE BOTTOM DECK ONLY

PART NUMBER	NETT. PRICE		PART NUMBER	NETT. PRICE	
	£ STERLING	€ EUROS		£ STERLING	€ EUROS
04-2B3B	£206.44	€ 278.69	04-2B2	£206.44	€ 278.69
04-3C2	£206.44	€ 278.69	04-3C40	£206.44	€ 278.69
04-3C3	£206.44	€ 278.69	04-3C5	£206.44	€ 278.69
04-3C4	£206.44	€ 278.69	04-3C60	£206.44	€ 278.69
04-3C6	£206.44	€ 278.69	04-3C6	£206.44	€ 278.69
			04-3C10	£206.44	€ 278.69
			04-3C12	£206.44	€ 278.69
			04-3C25	£206.44	€ 278.69

2B= 2 POSITION VALVE. 3C= 3 POSITION VALVE

Standard spool configurations available for all valves spring centred 3 position

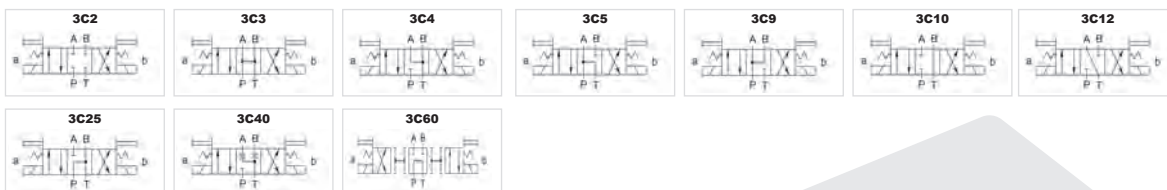

Standard spool configurations available for all valves spring offset 2 position



**FOR ALL OTHER SPOOL TYPES  
PLEASE CONTACT THE FLOWFIT SALES TEAM.**

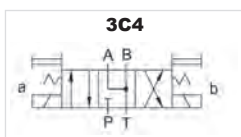

Flowfit Cetop 3/NG6 series hydraulic operated directional valve used to change direction of hydraulic oil by moving in main spool when the valve receives a hydraulic signal from the pilot hydraulic oil.

PART NUMBER	VOLTAGE	NETT. PRICE	
		£ STERLING	€ EUROS
F5-02-3C4-D1	12 VDC	£50.63	€ 68.35
F5-02-3C4-D2	24 VDC	£50.63	€ 68.35
F5-02-3C4-A1	110 VAC	£50.63	€ 68.35
F5-02-3C4-A2	240 VAC	£50.63	€ 68.35

## FLOWFIT CETOP 7 SUBPLATE

www.flowfitonline.com  
TECH. DATA SHEET  
**FCV36**



Bottom ported or side ported 3/4" BSP Ports

CODE	DESCRIPTION	PRICE
		£ STERLING € EUROS
DSGM-04-06-B4-BSP	CETOP 7, 3/4" BSP PORTS IN BOTTOM	£94.86 € 128.06
DSGM-04-06-S4-BSP	CETOP 7, 3/4" BSP SIDE PORTS	£94.86 € 128.06

## FLOWFIT SIDE ENTRY CETOP 7



www.flowfitonline.com  
TECH. DATA SHEET  
**FCV37**

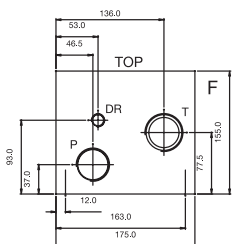
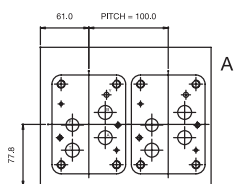
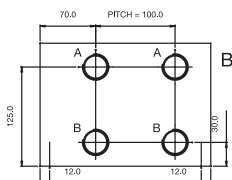
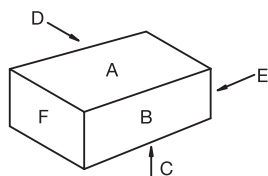

### ORDERING CODE INFORMATION

- Steel** Code No. 705161/★  
Available on request  
★ = Number of stations
- Material** Steel  
Alum. Alloy
- Working Pressure** Steel 315 Bar
- 'A' and 'B' Ports** 1" BSP
- 'P' and 'T' Ports** 1" BSP
- 'DR' Port** 3/8" BSP Through
- Valve Fixings** M10 x 16  
Full Thread  
M6 x 12  
Full Thread
- Manifold Fixings Pitch** M12 x 20 Deep  
100.0mm

SIDE ENTRY • CETOP 7				
ORDER CODE	NUMBER OF STATIONS	OVERALL LENGTH	OVERALL WEIGHT	NETT. PRICE
				£ STERLING € EUROS
705161/1	ONE	115.0	21.0 Kgs	£653.30 € 881.95
705161/2	TWO	215.0	38.0 Kgs	£1,078.01 € 1,455.32
705161/3	THREE	315.0	47.0 Kgs	£1,598.88 € 2,158.48

## FLOWFIT CETOP 7 RELIEF VALVES

www.flowfitonline.com  
TECH. DATA SHEET  
**FCV38**

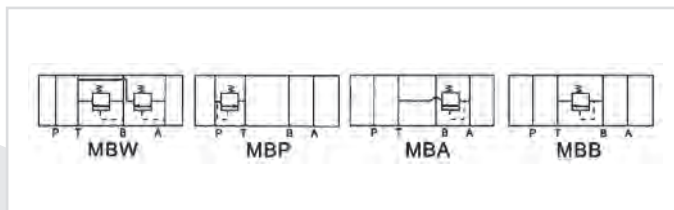

CODE	NETT. PRICE
	£ STERLING € EUROS
MBW-04-★	£310.21 € 418.78
MBP-04-H	£310.21 € 418.78
MBA-04-★	£310.21 € 418.78
MBB-04-★	£310.21 € 418.78

Pressure Ranges B = 7 - 70 Bar, C = 35 - 140 Bar, H = 70 - 250 Bar  
Max. Flow 06 = 200 l/m • ★ = Pressure Range

## FLOWFIT CETOP 7 PRESSURE REDUCING VALVES

www.flowfitonline.com  
TECH. DATA SHEET  
**FCV39**

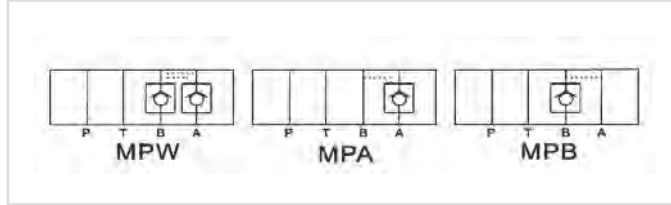

CODE	NETT. PRICE	
	£ STERLING	€ EUROS
MRP-04-★	£620.43	€ 837.57
MRA-04-★	£620.43	€ 837.57
MRB-04-★	£620.43	€ 837.57
Pressure Ranges A = 3 - 35 Bar, B = 8 - 70 Bar, C = 8 - 140 Bar, H = 70 - 250 Bar		
Max. Flow 06 = 200 l/m • ★ = Pressure Range		

## FLOWFIT CETOP 7 CHECK VALVES

www.flowfitonline.com  
TECH. DATA SHEET  
**FCV40**

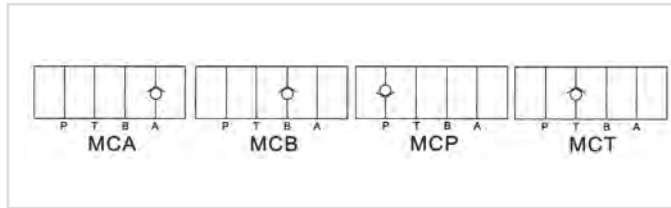

CODE	MAX OPERATING PRESSURE	NETT. PRICE	
		£ STERLING	€ EUROS
MCP-04-★	250 BAR	£233.22	€ 314.84
Cracking Pressure A = 0.5 Bar, B = 3.5 Bar			
Max. Flow 04 = 200 l/m • ★ = Cracking Pressure			

## FLOWFIT CETOP 7 PILOT OPERATED CHECK VALVES

www.flowfitonline.com  
TECH. DATA SHEET  
**FCV41**

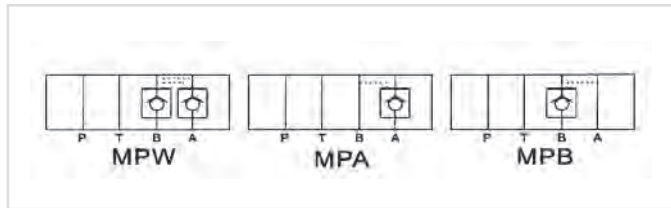

CODE	MAX OPERATING PRESSURE	NETT. PRICE	
		£ STERLING	€ EUROS
MPA-04-★	250 BAR	£278.96	€ 376.61
MPB-04-★	250 BAR	£278.96	€ 376.61
MPW-04-★	250 BAR	£332.53	€ 448.92
Cracking Pressure A = 0.5 Bar, B = 3.5 Bar			
Max. Flow 04 = 200 l/m • ★ = Cracking Pressure			

## FLOWFIT CETOP 7 COUNTER BALANCE VALVE

www.flowfitonline.com  
TECH. DATA SHEET  
**FCV42**



CODE	MAX OPERATING PRESSURE	NETT. PRICE	
		£ STERLING	€ EUROS
MHA-04-★	250 BAR	£342.13	€ 461.88
MHB-04-★	250 BAR	£342.13	€ 461.88
Pressure Range B = 8-70 Bar, C = 20-250 Bar			
Max. Flow 04 = 200 l/m • ★ = Cracking Pressure			

## FLOWFIT CETOP 7 FLOW CONTROL C/W CHECK VALVE

www.flowfitonline.com  
TECH. DATA SHEET  
**FCV43**

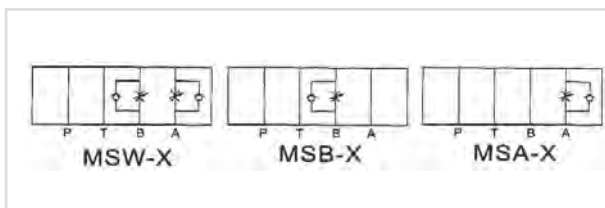

CODE	MAX OPERATING PRESSURE	NETT. PRICE	
		£ STERLING	€ EUROS
MSA-04-★	250 BAR	£306.86	€ 414.27
MSB-04-★	250 BAR	£306.86	€ 414.27
MSW-04-H	250 BAR	£332.53	€ 448.92
Metering X = Meter Out, Y = Meter In			
Max. Flow 04 = 200 l/m • ★ = Metering In or Out			

# FLOWFIT CETOP 8 NG25 SOLENOID PILOT OPERATED DIRECTIONAL CONTROL VALVES

www.flowfitonline.com  
TECH. DATA SHEET  
**FCV44**



Flowfit offer a large range of solenoid pilot operated directional control valves.

The spool is controlled to shift flow direction of system by piloted pressure sent from a NG6/Cetop 3 solenoid directional control valve mounted on top of the main valve. This NG6/Cetop 3 valve is a double acting spool type 3C4.

This Cetop 3 valve solenoid controls the pilot flow on the main deck valve which will then control higher pressures and larger flows.

**SPECIFICATION**

- Nominal Size:** NG25 Cetop 8
- Rated Flow:** 300 l/min
- Max Flow:** 500 l/min
- Max Operating Pressure:** 250 Bar
- Max Pressure A, B, P Port:** 315 Bar
- Min Pilot Pressure:** 8 Bar
- Max Pilot Pressure:** 210 Bar
- Max Operating Frequency:** 120 CPM
- Weight:** 13.7kg
- Max Working Pressure 'T' Port External Drain:** 250 BAR
- Max Working Pressure 'T' Port Internal Drain:** 160 Bar DC  
100 Bar AC
- Max Working Pressure 'Y' Port Internal Drain:** 160 Bar DC  
100 Bar AC

THESE VALVES ARE THE BOTTOM DECK ONLY

PART NUMBER	NETT. PRICE		PART NUMBER	NETT. PRICE	
	£ STERLING	€ EUROS		£ STERLING	€ EUROS
06-2B3B	£252.05	€ 340.26	06-2B2	£252.05	€ 340.26
06-3C2	£252.05	€ 340.26	06-3C40	£238.82	€ 322.41
06-3C3	£252.05	€ 340.26	06-3C5	£252.05	€ 340.26
06-3C4	£252.05	€ 340.26	06-3C60	£238.82	€ 322.41
06-3CG	£252.05	€ 340.26	06-3C9	£252.05	€ 340.26
			06-3C10	£238.82	€ 322.41
			06-3C12	£238.82	€ 322.41
			06-3C25	£238.82	€ 322.41

2B= 2 POSITION VALVE. 3C= 3 POSITION VALVE

Standard spool configurations available for all valves spring centred 3 position

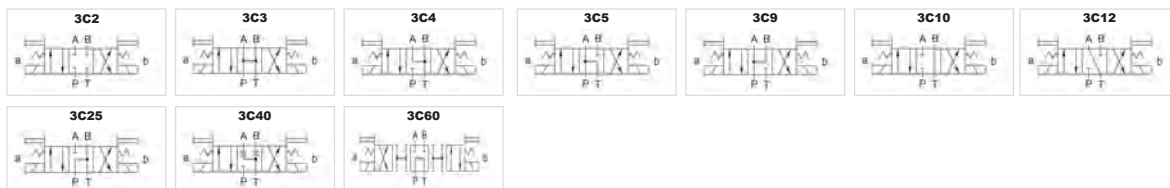

Standard spool configurations available for all valves spring offset 2 position



**FOR ALL OTHER SPOOL TYPES  
PLEASE CONTACT THE FLOWFIT SALES TEAM.**

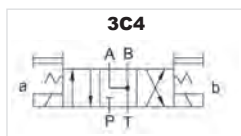

Flowfit Cetop 3/NG6 series hydraulic operated directional valve used to change direction of hydraulic oil by moving in main spool when the valve receives a hydraulic signal from the pilot hydraulic oil.

PART NUMBER	VOLTAGE	NETT. PRICE	
		£ STERLING	€ EUROS
F5-02-3C4-D1	12 VDC	£50.63	€ 68.35
F5-02-3C4-D2	24 VDC	£50.63	€ 68.35
F5-02-3C4-A1	110 VAC	£50.63	€ 68.35
F5-02-3C4-A2	240 VAC	£50.63	€ 68.35

## FLOWFIT CETOP 8 SUBPLATE



Bottom ported or side ported 3/4" BSPP Ports

www.flowfitonline.com  
TECH. DATA SHEET  
**FCV45**

CODE	DESCRIPTION	PRICE	
		£ STERLING	€ EUROS
DSGM-06-06-B4-BSPP	CETOP 8, 3/4" BSP PORTS IN BOTTOM	£140.61	€ 189.82
DSGM-06-06-S4-BSPP	CETOP 8, 3/4" BSP SIDE PORTS	£140.61	€ 189.82

## FLOWFIT SIDE ENTRY CETOP 8



www.flowfitonline.com  
TECH. DATA SHEET  
**FCV46**

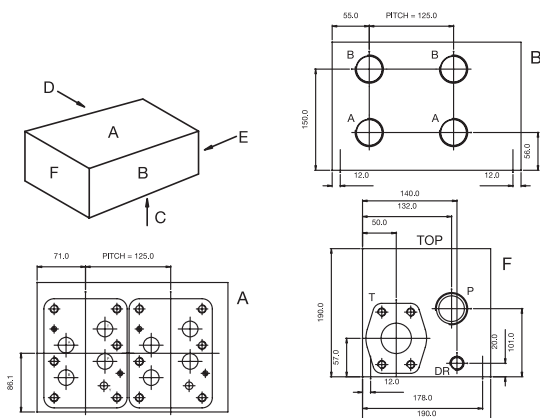

### ORDERING CODE INFORMATION

<b>Steel</b>	Code No. 805161/★ Available on request ★ = Number of stations
<b>Material</b>	Steel
<b>Working Pressure</b>	Steel 315 Bar
<b>'A' and 'B' Ports</b>	1 1/4" BSP
<b>'P' Port</b>	1 1/2" BSP Through
<b>T' Port</b>	2" SAE 3000 Flange Through
<b>DR' Port</b>	1/2" BSP Through
<b>Valve Fixings</b>	M12 x 20 Full Thread
<b>Manifold Fixings</b>	M12 x 20 Deep Full Thread
<b>Pitch</b>	125.0mm

### SIDE ENTRY • CETOP 8

ORDER CODE	NUMBER OF STATIONS	OVERALL LENGTH	OVERALL WEIGHT	NETT. PRICE	
				£ STERLING	€ EUROS
805161/1	ONE	155.0	21.0 Kgs	£917.98	€ 1,239.27
805161/2	TWO	280.0	38.0 Kgs	£1,551.91	€ 2,095.07

## FLOWFIT CETOP 8 RELIEF VALVES

www.flowfitonline.com  
TECH. DATA SHEET  
**FCV47**

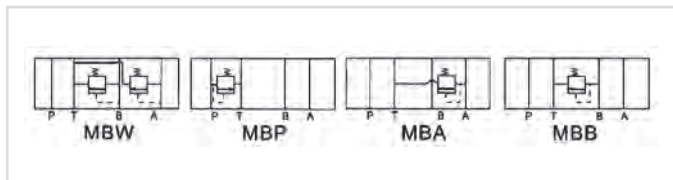

CODE	NETT. PRICE	
	£ STERLING	€ EUROS
MBP-06-★	£435.78	€ 588.31
MBA-06-★	£435.78	€ 588.31
MBB-06-★	£435.78	€ 588.31
MBW-06-★	£435.78	€ 588.31

Pressure Ranges B = 7 - 70 Bar, C = 35 - 140 Bar, H = 70 - 250 Bar

Max. Flow 08 = 200 l/m • ★ = Pressure Range

## FLOWFIT CETOP 8 PRESSURE REDUCING VALVES

www.flowfitonline.com  
TECH. DATA SHEET  
**FCV48**

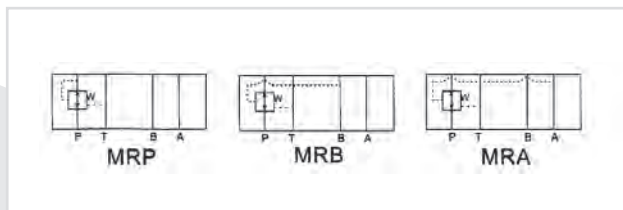

CODE	NETT. PRICE	
	£ STERLING	€ EUROS
MRP-06-H	£388.32	€ 434.88
MRA-06-★	£388.32	€ 434.88
MRB-06-★	£388.32	€ 434.88

Pressure Ranges A = 3 - 35 Bar, B = 8 - 70, C = 8 - 140 Bar, H = 70 - 250 Bar

Max. Flow 08 = 200 l/m • ★ = Pressure Range



## FLOWFIT CETOP 8 FLOW CONTROL C/W CHECK VALVE

www.flowfitonline.com  
TECH. DATA SHEET  
**FCV49**

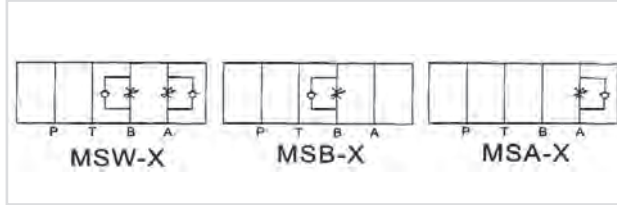

CODE	NETT. PRICE	
	£ STERLING	€ EUROS
MSA-06-★	£311.28	€ 420.23
MSB-06-★	£311.28	€ 420.23
MSW-06-Y	£373.54	€ 504.27

Metering X = Meter Out, Y = Meter In  
Max. Flow 06 = 200 l/m • ★ = Metering In or Out

## FLOWFIT CETOP 8 PILOT OPERATED CHECK VALVES

www.flowfitonline.com  
TECH. DATA SHEET  
**FCV50**

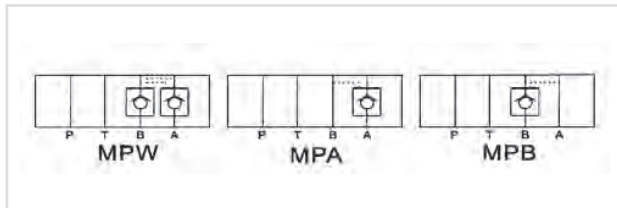

CODE	NETT. PRICE	
	£ STERLING	€ EUROS
MPA-06-★	£435.78	€ 588.31
MPB-06-★	£435.78	€ 588.31
MPW-06-A	£373.54	€ 504.27

A = 0.5 Bar, B = 3.5 Bar, C = 4.6 Bar  
06 = 200 l/m • ★ = Cracking Pressure

## FLOWFIT CETOP 8 CHECK VALVES

www.flowfitonline.com  
TECH. DATA SHEET  
**FCV51**

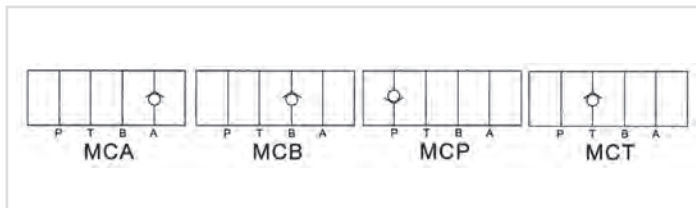
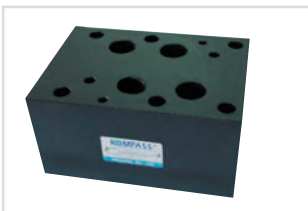

CODE	NETT. PRICE	
	£ STERLING	€ EUROS
MCP-06-★	£240.52	€ 324.70
MCA-06-★	£240.51	€ 324.68
MCB-06-★	£240.56	€ 324.76
MCT-06-★	£240.51	€ 324.68

Cracking Pressure A = 0.5 Bar, B = 3.5 Bar, C = 4.6 Bar  
Max. Flow 06 = 200 l/m • H = Cracking Pressure

## FLOWFIT CETOP 8 COUNTER BALANCE VALVE

www.flowfitonline.com  
TECH. DATA SHEET  
**FCV52**



CODE	MAX OPERATING PRESSURE	NETT. PRICE	
		£ STERLING	€ EUROS
MHA-06-★	250 BAR	£468.67	€ 632.70
MHB-06-★	250 BAR	£468.67	€ 632.70

Pressure Range B = 8-70 Bar, C = 20-250 Bar

Max. Flow 06 = 200 l/m • ★ = Cracking Pressure

## FLOWFIT CETOP 10 NG32 SOLENOID PILOT OPERATED DIRECTIONAL CONTROL VALVES

www.flowfitonline.com  
TECH. DATA SHEET  
**FCV53**



Flowfit offer a large range of solenoid pilot operated directional control valves.

The spool is controlled to shift flow direction of system by piloted pressure sent from a NG6/Cetop 3 solenoid directional control valve mounted on top of the main valve. This NG6/Cetop 3 valve is a double acting spool type 3C4.

This Cetop 3 valve solenoid controls the pilot flow on the main deck valve which will then control higher pressures and larger flows.

### SPECIFICATION

**Nominal Size:** NG32 Cetop 10  
**Rated Flow:** 500 l/min  
**Max Flow:** 1000 l/min  
**Max Operating Pressure:** 250 Bar  
**Max Pressure A, B, P Port:** 315 Bar  
**Min Pilot Pressure:** 8 Bar  
**Max Pilot Pressure:** 210 Bar  
**Max Operating Frequency:** 120 CPM  
**Weight:** 45.3kg  
**Max Working Pressure 'T' Port External Drain:** 250 Bar  
**Max Working Pressure 'T' Port Internal Drain:** 160 Bar DC, 100 Bar AC  
**Max Working Pressure 'Y' Port External Drain:** 160 Bar DC, 100 Bar AC

THESE VALVES ARE THE BOTTOM DECK ONLY

PART NUMBER	NETT. PRICE		PART NUMBER	NETT. PRICE	
	£ STERLING	€ EUROS		£ STERLING	€ EUROS
10-2B3B	£716.46	€ 967.23	10-2B2	£990.89	€ 1,337.70
10-3C2	£990.89	€ 1,337.70	10-3C5	£716.46	€ 967.23
10-3C3	£990.89	€ 1,337.70	10-3C60	£716.46	€ 967.23
10-3C4	£990.89	€ 1,337.70	10-3C9	£990.89	€ 1,337.70
10-3C6	£990.89	€ 1,337.70	10-3C10	£716.46	€ 967.23
			10-3C12	£716.46	€ 967.23

2B = 2 POSITION VALVE. 3C = 3 POSITION VALVE

Standard spool configurations available for all valves spring centred 3 position

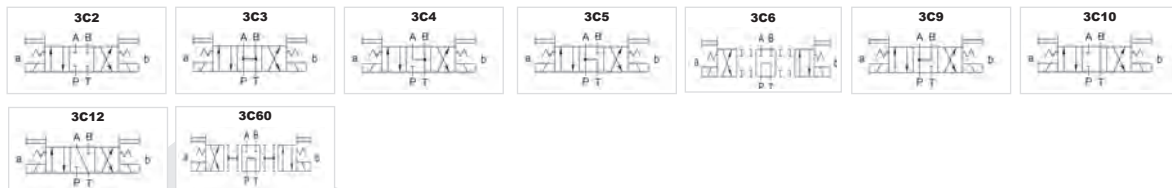

Standard spool configurations available for all valves spring offset 2 position

For 2 position Cetop Base decks the pilot valve must be a 2BZ spool on Page 19 & 24.



**FOR ALL OTHER SPOOL TYPES  
PLEASE CONTACT THE FLOWFIT SALES TEAM.**

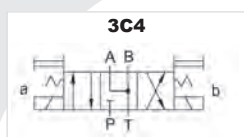

Flowfit Cetop 3/NG6 series hydraulic operated directional valve used to change direction of hydraulic oil by moving in main spool when the valve receives a hydraulic signal from the pilot hydraulic oil.

PART NUMBER	VOLTAGE	NETT. PRICE	
		£ STERLING	€ EUROS
F5-02-3C4-D1	12 VDC	£50.63	€ 68.35
F5-02-3C4-D2	24 VDC	£50.63	€ 68.35
F5-02-3C4-A1	110 VAC	£50.63	€ 68.35
F5-02-3C4-A2	240 VAC	£50.63	€ 68.35

# FLOWFIT CETOP 10 SUBPLATE



Bottom ported  
1 1/4" NPT Ports

www.flowfitonline.com  
TECH. DATA SHEET  
**FCV54**

CODE	DESCRIPTION	NETT. PRICE	
		£ STERLING	€ EUROS
DSGM-10-10-B4-NPT	CETOP 10, 1 1/4" NPT PORTS IN BOTTOM	£267.81	€ 361.54

## KOMPASS RELIEF VALVES

### KOMPASS DIRECT OPERATED RELIEF VALVE

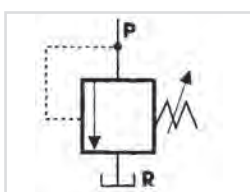

DG-02 & DT-02 are direct operating relief valves.  
DG-01 & DT-01 are remote control type.

www.flowfitonline.com  
TECH. DATA SHEET  
**FCV55**

SUBPLATE MOUNTED	MAX FLOW L/MIN	MAX PRESSURE BAR	NETT. PRICE	
			£ STERLING	€ EUROS
DG-01-★	2	250	£39.05	€ 52.73
DG-02-★	16	250	£64.72	€ 87.38

THREADED PORTS IN LINE	MAX FLOW L/MIN	MAX PRESSURE BAR	PRICE	
			£ STERLING	€ EUROS
DT-01-H	2	250	£37.20	€ 50.21
DT-02-★	16	250	£61.64	€ 83.20

Pressure Ranges B = 10 - 70 Bar, C = 35 - 140 Bar, H = 70 - 250 Bar Max. Flow 01 = 2 l/m, 02 = 16 l/m • ★ = Pressure Range G = Subplate Mtd. T = Threaded Ports

### KOMPASS PILOT OPERATED RELIEF VALVE

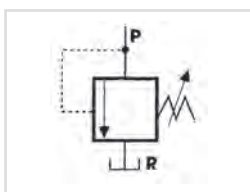

This valve is able to pre-select max pressure of pump & control valves to prevent damage or overload.

- BG/BT Pilot Operated Relief Valve
- BHG/BHT Pilot Operated Relief Valve – Reinforced type
- SBG Pilot Operated Relief Valve – Low noise, smooth, stable operation

www.flowfitonline.com  
TECH. DATA SHEET  
**FCV56**

SUBPLATE MOUNTED	MAX FLOW L/MIN	MAX PRESSURE BAR	NETT. PRICE	
			£ STERLING	€ EUROS
BG-03-★	100	250	£104.90	€ 141.61
BG-06-★	200	250	£116.06	€ 156.68
BG-10-★	400	250	£220.94	€ 298.26
BHG-06-★	200	250	£116.06	€ 156.68
BHG-10-★	400	250	£265.58	€ 358.54
SBG-03-★	100	250	£131.67	€ 177.76
SBG-06-★	200	250	£147.28	€ 198.83
SBG-10-★	400	250	£399.47	€ 539.29

Subplate Sizes 03 = Cetop 6R, 06 = Cetop 8R, 10 = Cetop 10R

THREADED PORTS IN LINE	PORTS	MAX FLOW L/MIN	MAX PRESSURE BAR	PRICE	
				£ STERLING	€ EUROS
BT-03-H	3/8"	100	250	£78.12	€ 105.46
BT-06-H	3/4"	200	250	£100.43	€ 135.58
BT-10-H	1 1/4"	400	250	£209.78	€ 283.20
BHT-03-H	3/8"	100	250	£78.13	€ 105.47
BHT-06-H	3/4"	200	250	£109.35	€ 147.63
BHT-10-H	1 1/4"	400	250	£209.78	€ 283.20

Pressure Ranges B = 10 - 70 Bar, C = 35 - 140 Bar, H = 70 - 250 Bar Max. Flow 03 = 100 l/m, 06 = 200 l/m, 10 = 400 l/m • H = Pressure Range

## KOMPASS SOLENOID CONTROLLED RELIEF VALVE

www.flowfitonline.com  
TECH. DATA SHEET  
**FCV57**

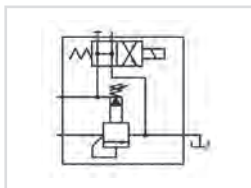

These valves incorporate combinations with solenoid directional control valves.

- BSH Solenoid Control Pilot Operated Relief Valve
- SBSG Solenoid Control Pilot Operated Relief Valve – Low noise, smooth, stable operation

SUBPLATE MOUNTED	MAX FLOW L/MIN	NETT. PRICE	
		£ STERLING	€ EUROS
BSG-03-★	100	£209.79	€ 234.94
BSG-06-★	200	£220.88	€ 247.36
BSG-10-★	400	£354.84	€ 397.40
SBSG-03-H	100	£315.79	€ 353.67
SBSG-10-H	400	£355.17	€ 479.48
SBSG-06-H	200	£326.96	€ 441.39

Subplate Sizes 03 = Cetop 6R, 06 = Cetop 8R, 10 = Cetop 10R

THREADED PORTS IN LINE	PORTS	MAX FLOW L/MIN	PRICE	
			£ STERLING	€ EUROS
BST-03-★	3/8"	100	£171.84	€ 231.98
BST-06-★	3/4"	200	£183.01	€ 247.06
BST-10-★	1 1/4"	400	£283.42	€ 382.62

Pressure Ranges B = 10 - 70 Bar, C = 35 - 140 Bar, H = 70 - 250 Bar Max. Flow 03 = 100 l/m, 06 = 200 l/m, 10 = 400 l/m • ★ = Pressure Range

BS	G	6	H	2B2	A2	5	D5	2P
SERIES NBR	TYPE OF CONNECTION	VALVE SIZE	PRESS. RANGE BAR	TYPE OF FUNCTION	SOLENOID TYPE	HERTZ	TERMINAL	CONTROLS
BS, BS	G=SUBPLATE	3	B = 10 - 70	For Venting Conditions See Below	A1=AC110V	5=50hz	D4=JIS	NONE=SINGLE PRESSURE
BHS, BHS	T=THREADED	6	C = 35 - 140		A2=AC220V	6=60hz	D5=DIN	2P=DUO PRESSURE
SBS		10	H = 70 - 250		D1=DC12V			3P=TRI PRESSURE

D2=DC24V

## KOMPASS UNLOADING RELIEF VALVE

www.flowfitonline.com  
TECH. DATA SHEET  
**FCV58**



Use for accumulator or hi-lo pressure pump systems.

SUBPLATE MOUNTED	MAX FLOW L/MIN	MAX PRESSURE BAR	NETT. PRICE	
			£ STERLING	€ EUROS
BUCG-06-★	125	250	£371.96	€ 502.15

Pressure Ranges B = 10 - 70 Bar, C = 35 - 140 Bar, H = 70 - 250 Bar  
Max. Flow 125 l/m • ★ = Pressure Range

## KOMPASS UNLOADING RELIEF VALVE

www.flowfitonline.com  
TECH. DATA SHEET  
**FCV59**



Use for accumulator or hi-lo pressure pump systems.

SUBPLATE MOUNTED	MAX FLOW L/MIN	MAX PRESSURE BAR	NETT. PRICE	
			£ STERLING	€ EUROS
BUCG-06-H	125	250	£401.71	€ 542.30

Pressure Ranges H = 70 - 250 Bar Max. Flow 125 l/m • ★ = Pressure Range

## KOMPASS<sup>®</sup> PRESSURE REDUCING VALVE

www.flowfitonline.com  
TECH. DATA SHEET  
**FCV60**



Pressure which is lower than main system can be obtained by setting reducing valve.

**R**  
REDUCING VALVE

**RC**  
REDUCING VALVE WITH CHECK VALVE

SUBPLATE MOUNTED	MAX FLOW L/MIN	MAX PRESSURE BAR	NETT. PRICE	
			£ STERLING	€ EUROS
RG-03-H	50	250	£133.91	€ 180.78
RCG-03-H	50	250	£167.38	€ 225.96
RG-06-H	125	250	£167.38	€ 225.96
RCG-06-H	125	250	£243.27	€ 328.41
RG-10-★	250	250	£343.69	€ 463.99
RCG-10-H	250	250	£444.12	€ 599.56

Subplate Sizes 03 = Cetop 6P, 06 = Cetop 8P, 10 = Cetop 10P

THREADED PORTS IN LINE	PORTS	MAX FLOW L/MIN	MAX PRESSURE BAR	NETT. PRICE	
				£ STERLING	€ EUROS
RT-03-H	3/8"	50	250	£133.91	€ 180.78
RCT-03-H	3/8"	50	250	£167.39	€ 225.98
RT-06-H	3/4"	125	250	£167.39	€ 225.98
RCT-06-H	3/4"	125	250	£243.26	€ 328.40
RT-10-★	1 1/4"	250	250	£364.32	€ 491.83
RCT-10-★	1 1/4"	250	250	£470.77	€ 635.55

Pressure Ranges B = 5 - 70 Bar, C = 35 - 140 Bar, H = 70 - 250 Bar Max. Flow 03 = 50 l/m, 06 = 125 l/m, 10 = 250 l/m • ★ = Pressure Range

RG/T = Reducing, RCG/T = Reducing c/w Integral Check Valve

## SEQUENCE, COUNTER BALANCE & UNLOADING

### KOMPASS<sup>®</sup> SEQUENCE, COUNTER BALANCE & UNLOADING

www.flowfitonline.com  
TECH. DATA SHEET  
**FCV61**



These valves are direct operated pressure control & contain pilot pressure ports which can be operated by internal or external pilots.

Buy 1 valve - covers any one of Sequence, Counter Balance and Unloading Valve all in one. Ask for details.

SUBPLATE MOUNTED	MAX FLOW L/MIN	MAX PRESSURE BAR	NETT. PRICE	
			£ STERLING	€ EUROS
HG-03-★	50	250	£131.67	€ 177.76
HG-06-★	125	250	£149.53	€ 201.86
HG-10-★	250	250	£200.50	€ 270.68
HCG-03-★	50	250	£131.67	€ 177.76
HCG-06-★	125	250	£194.16	€ 262.12
HCG-10-★	250	250	£299.05	€ 403.71

Subplate Sizes 03 = ISO 5781-AG-06-2-A, 06 = ISO 5781-AG-08-2-A, 10 = ISO 5781-AJ-10-2-A

THREADED PORTS IN LINE	MAX FLOW L/MIN	MAX PRESSURE BAR	NETT. PRICE	
			£ STERLING	€ EUROS
HT-03-★	50	250	£122.75	€ 165.72
HT-06-★	125	250	£127.21	€ 171.74
HT-10-★	250	250	£216.49	€ 292.25
HCT-03-★	50	250	£131.67	€ 177.76
HCT-06-★	125	250	£167.38	€ 225.96
HCT-10-★	250	250	£265.58	€ 358.54

Pressure Ranges A = 18 - 35 Bar, B = 35 - 70 Bar, C = 70 - 140 Bar, H = 70 - 250 Bar Max. Flow 03 = 50 l/m, 06 = 125 l/m, 10 = 250 l/m • ★ = Pressure Range

C = Added to Designate Integral Check

## 2 WAY CARTRIDGE ELECTRIC VALVES

### 2 WAY, 2 POSITION PILOT OPERATED SOLENOID VALVES POPPET TYPE

www.flowfitonline.com  
TECH. DATA SHEET  
**FCV62**

EV★★

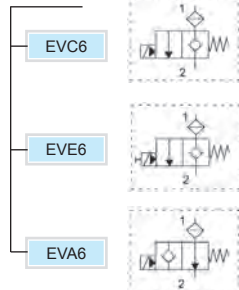

★★★

140	BSP 1/4"
380	BSP 3/8"



★★★★★

012DC	12VDC
024DC	24VDC
02450	24V/50HZ
11050	110V/50HZ
22050	220V/50HZ
024RAC	24RAC
110RAC	110RAC
220RAC	220RAC

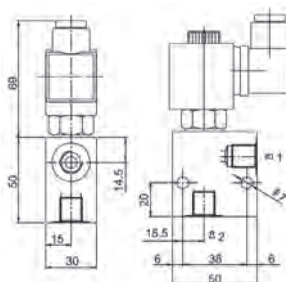

- Max Pressure 210 Bar
- Max Flow 22 L/min
- Protection IP65
- Feeding Tolerance +/-10%

- Energising Time ED 100%
- Insulation Class H
- Absorbed Power in A.C. 20VA
- Absorbed Power at pickup 28 VA

- Absorbed Power in DC 18W
- Weight 0.25kg
- Steel Body Nickel Plated

ORDER CODE	NETT. PRICE	
	£ STERLING	€ EUROS
EVC6-★★-★★★★★	£48.60	€ 65.61
EVE6-★★-★★★★★	£53.46	€ 72.18
EVA6-★★-★★★★★	£56.16	€ 75.82

## ELECTRO-HYDRAULIC PROPORTIONAL VALVES

### KOMPASS® ELECTRO-HYDRAULIC PROPORTIONAL PILOT RELIEF VALVE

www.flowfitonline.com  
TECH. DATA SHEET  
**FCV63**

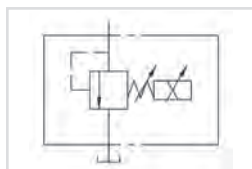

MODEL	FLOW L/M	PRESSURE ADJ RANGE (BAR)	RATED CURRENT MA	COIL RESISTANCE	HYSTERESIS	REPEATABILITY
EDG-01	03 - 2	B = 5 - 70	800	10	3%	1%
		C = 10 - 160	900			
		H = 12 - 250	950			

SERIES NBR	VALVE SIZE	PRESSURE ADJ. RANGE	CONTROL
EDG	O1	B = 5 - 70	* = Normal
		C = 10 - 160	V = Unloading
		H = 12 - 250	Control Type

CODE	NETT. PRICE	
	£ STERLING	€ EUROS
EDG-01-*	£290.12	€ 391.66

**KOMPASS ELECTRO-HYDRAULIC PROPORTIONAL RELIEF VALVE**

www.flowfitonline.com  
TECH. DATA SHEET  
**FCV64**

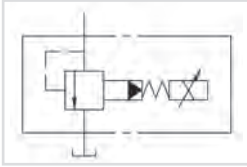

MODEL	FLOW L/MIN	PRESSURE ADJ RANGE (BAR)	RATED CURRENT MA	COIL RESISTANCE	HYSTERESIS	REPEATABILITY
EBG-03	3 - 100	C = 5 - 160	C:770/H:820			
EBG-06	3 - 200		C:750/H:800	10	2%	1%
EBG-10	3 - 400	H = 10 - 250	C:730/H:780			

SERIES NBR	VALVE SIZE	PRESSURE ADJ. RANGE	SAFETY VALVE
EBG	O3	C = 5 - 160	* = With
	O6		T = Without
	10	H = 10 - 250	

CODE	NETT. PRICE	
	£ STERLING	€ EUROS
EBG-03	£444.12	€ 599.56
EBG-06	£409.37	€ 552.66
EBG-10	£632.71	€ 854.15

**KOMPASS ELECTRO-HYDRAULIC PROPORTIONAL RELIEF & FLOW CONTROL VALVE**

www.flowfitonline.com  
TECH. DATA SHEET  
**FCV65**

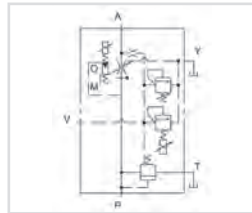

MODEL	DESCRIPTION	EFBG-03-125	EFBG-06-250	EFBG-10-500
Flow Control	Metered Flow Adj. Range	1 - 125	2.5 - 250	5 - 500
	Rated Current (mA)	680	580	700
	Coil Resistance (Ohms)	43.5	43.5	43.5
	Differential Pressure	6	7	9
	Hysteresis	<7%	<7%	<7%
	Repeatability	1%	1%	1%
Pressure Control	Pressure Adj. Range	C = 14 - 140	C = 15 - 140	C = 16 - 140
	Bar	H = 14 - 210	H = 15 - 210	H = 16 - 210
	Rated Current (mA)	C = 710	C = 690	C = 690
		H = 770	H = 730	H = 690
	Coil Resistance (Ohms)	10	10	10
	Hysteresis	>3%	>3%	>3%
	Repeatability	1%	1%	1%

SERIES NBR.	VALVE SIZE	MAX. ADJ. FLOW	PILOT RELIEF PRESS. ADJ. RANGE
EFBG	O3	125 -125l/min.	C = 14 - 140 Bar
	O6	250 =250l/min.	
	10	500 = 500l/min.	H = 14 - 210 Bar

CODE	NETT. PRICE	
	£ STERLING	€ EUROS
SUBPLATE EFBGM - 032-11		
EFBG-03	£956.47	€ 1,291.24
EFBG-06	£1,332.37	€ 1,798.70
EFBG-10	£3,205.92	€ 4,327.99

## KOMPASS POWER AMPLIFIERS FOR PROPORTIONAL VALVES

www.flowfitonline.com  
TECH. DATA SHEET  
**FCV66**

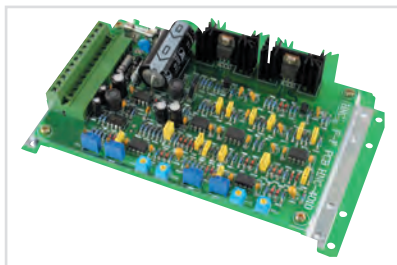

MODEL	FUNCTION	MAX OUTPUT	MAX INPUT	APPLICATION
HNC-1085	DC Input	1A (10 Ohms)	DC+10V	EDG-01 EBG-03 EBG-06

MODEL	SUPPLY VOLTAGE/ FUSE	LOAD COIL RESIS. FLOW	LOAD COIL RESIS. PRESSURE	INPUT CONTROL VOLTAGE	MAX CURRENT OUTPUT RANGE (FLOW)	MAX CURRENT OUTPUT RANGE (PRESSURE)
HNC-4010	DC Input	J3,J4 - 40 Ohms 20 Deg C	J5,J6 - 10 Ohms 20 Deg C	0V - +10V	FCT2 -0mA FCT2-750mA	PCT2-0mA PCT1 - 850mA

CODE	NETT. PRICE	
	£ STERLING	€ EUROS
HNC-1085	£185.22	€ 250.04