

HYDRAULIC CONTROL VALVES

MONOBLOCK DIRECTIONAL CONTROL VALVES.....	71
SLICE DIRECTIONAL CONTROL VALVES.....	73
HANDLEVERS	76
SPOOLS – additions for valves	76
VALVE CONTROL KITS – additions for valves	76
SOLENOID DIVERTER VALVES 3 way and 6 way.....	79
LEVER OPERATED DIVERTER VALVES.....	79

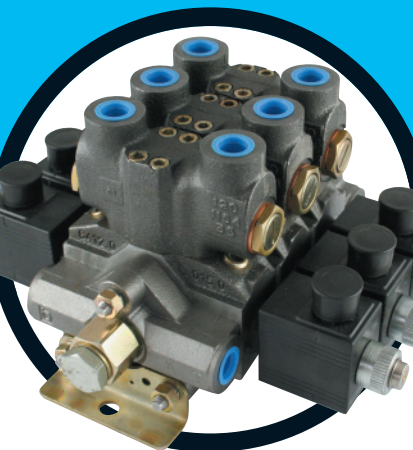
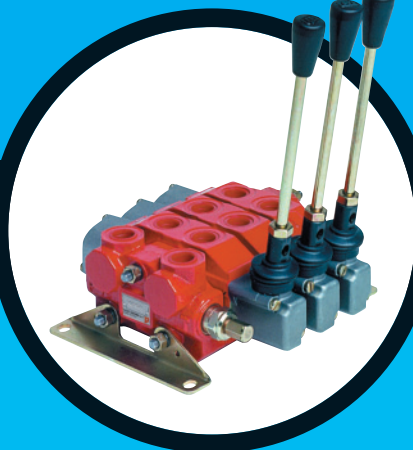
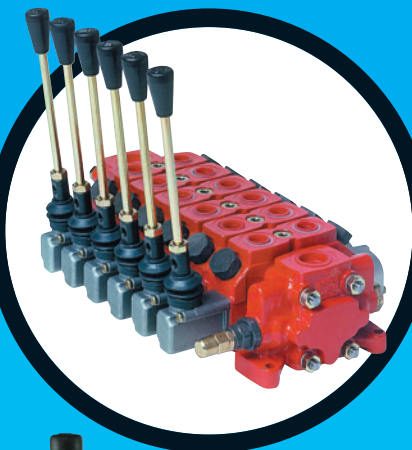

MONOBLOCK DIRECTIONAL CONTROL VALVES TYPE HDM

System Description

The valves of the HDM range are compact monoblock valves, available in 4 sizes. With the combination of different directional valves, stops, operators and shock-and/or anti-cavitation valves* this monoblock is adaptable to any requirements. The HDM valves are available with open centre, high pressure carryover or closed centre operation.

If you can't see what you need – please ask!

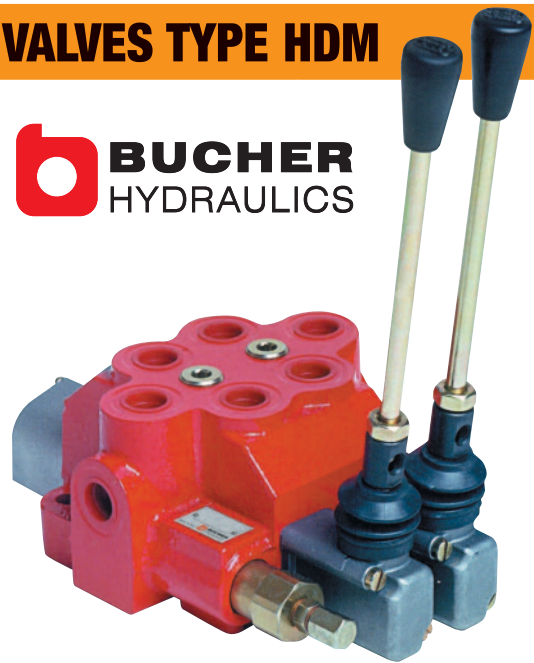

- **Lever control**
- **Electro hydraulic on/off**
- **Parallel and series circuits**
- **Unload in neutral, high pressure carryover**
- **Ancillary Valves: shock-and anticavitation valves, shock valves, check valves**

TECHNICAL DATA		HDM140	HDM 11 P	HDM 11 S	HDM 18	HDM 25	SD18
NUMBER OF SPOOLS		1	2-6	1-6	1-4	1-2	1-6
FLOW RATE	L/MIN	40	45	45	70	100	160
INLET PRESSURE MAX.	BAR	320	400	400	400	400	250
RETURN PRESSURE MAX.	BAR	30	30	30	30	30	25
FLUID		MINERAL OIL TO DIN 51524					
OPERATING TEMPERATURE	°C	-20 TO +80					
VISCOSITY RANGE	MM2/S	16 TO 75					
FILTRATION	MICRON	30					
DIRECTIONAL VALVE							
CONTROLS AVAILABLE		LEVER / CABLE CONTROL / ELECTRO HYDRAULIC (ON/OFF) / ELECTRO HYDRAULIC PROPORTIONAL					

SPOOLS AVAILABLE – PLUS MANY MORE

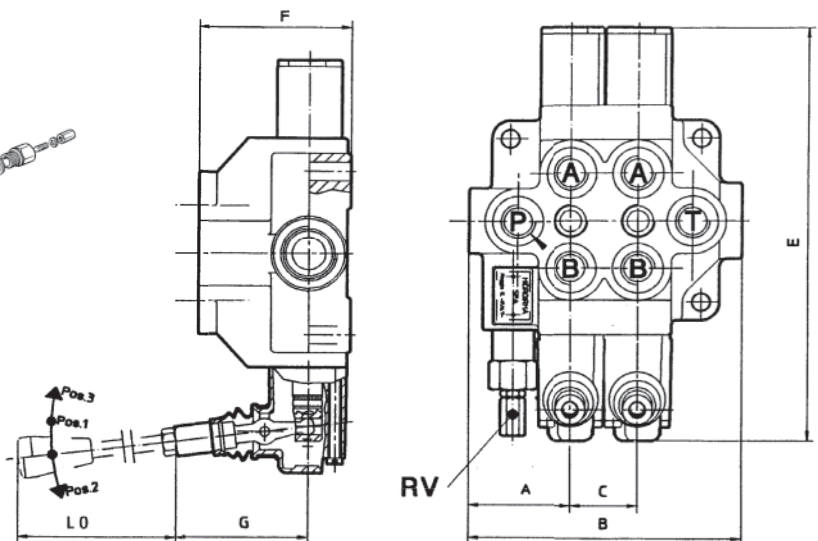
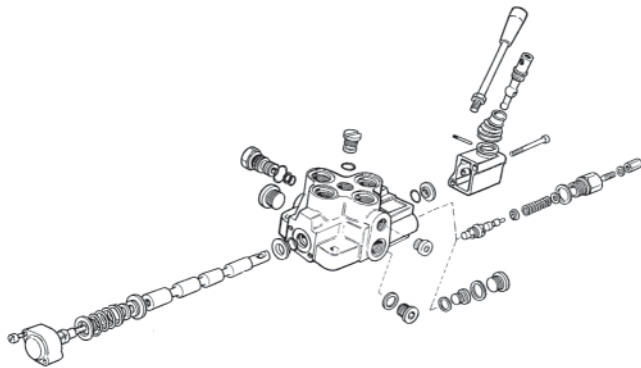

LEVER LENGTHS – mm						
HDM 140	150	200	250	300	-	
HDM 11	150	200	250	300	-	
HDM 18	-	185	250	300	350	
HDM 25	-	185	250	300	350	
SD18	150	200	250	300	-	

	A	B	C	E	F	G	P	T	A+B
HDM 140*	35	85	0	187	53	87		3/8" BSP	
HDM 11 P	51.3	28.6 X S + 128.6	28.6	180	57	66		3/8" BSP	
HDM 11 S	53.0	36 X S + 111	36	180	67	66		1/2" BSP	
HDM 18	60	40 X S + 115	40	216	72	73		1/2" BSP	
HDM 25	62	40 X S + 124	40	252	90	80		3/4" BSP	
SD 18	85	53 X S + 160	53	320	92	124		3/4" BSP	

S = NUMBER OF SPOOL -1

* SINGLE MONOBLOCK VALVE ONLY



EXCELLENT METERING!

3/8" PORTS MAX FLOW 40L/MIN MONOBLOCK HDM140 SERIES C/W MAIN RELIEF VALVE				
PART NO	DESCRIPTION		OPERATING PRESSURE BAR	PRICE
200.0514.12.024	HDM140 K02150A01 1 BANK DOUBLE ACTING SPRING RETURN LEVER OPERATED		320	£76.29
200.0514.12.047	HDM140 K02150G01 1 BANK SINGLE ACTING SPRING RETURN LEVER OPERATED		320	£76.29
200.0514.12.044	HDM140 K02150C03 1 BANK MOTOR SPOOL 3 POSITION DETENT LEVER OPERATED		320	£76.29



EXCELLENT METERING!

3/8" PORTS MAX FLOW 45L/MIN MONOBLOCK HDM11/P SERIES C/W MAIN RELIEF VALVE				
PART NO	DESCRIPTION		OPERATING PRESSURE BAR	PRICE
200.0611.22.182	HDM11P/2K04 150 A01 A01 2 BANK DOUBLE ACTING SPRING RETURN LEVER OPERATED		400	£178.59
200.0611.32.164	HDM11P/3K04 150 A01 A01 A01 3 BANK DOUBLE ACTING SPRING RETURN LEVER OPERATED		400	£251.86
200.0611.42.124	HDM11P/4K04 150 A01 A01 A01 A01 4 BANK DOUBLE ACTING SPRING RETURN LEVER OPERATED		400	£304.52
200.0611.52.078	HDM11P/5K04 150 A01 A01 A01 A01 A01 5 BANK DOUBLE ACTING SPRING RETURN LEVER OPERATED		400	£364.05
200.0611.62.026	HDM11P/6K04 150 A01 A01 A01 A01 A01 A01 6 BANK DOUBLE ACTING SPRING RETURN LEVER OPERATED		400	£412.13



EXCELLENT METERING!

1/2" PORTS MAX FLOW 45L/MIN MONOBLOCK HDM11/S SERIES C/W MAIN RELIEF VALVE				
PART NO	DESCRIPTION		OPERATING PRESSURE BAR	PRICE
200.0611.13.042	HDM11S/1K03 150 A01 1 BANK DOUBLE ACTING SPRING RETURN LEVER OPERATED		400	£144.24
200.0611.23.043	HDM11S/2K03 150 A01 A01 2 BANK DOUBLE ACTING SPRING RETURN LEVER OPERATED		400	£222.09
200.0611.33.044	HDM11S/3K03 150 A01 A01 A01 3 BANK DOUBLE ACTING SPRING RETURN LEVER OPERATED		400	£288.49
200.0611.43.040	HDM11S/4K03 150 A01 A01 A01 A01 4 BANK BANK DOUBLE ACTING SPRING RETURN LEVER OPERATED		400	£354.89
200.0611.53.037	HDM11S/5K03 150 A01 A01 A01 A01 A01 5 BANK DOUBLE ACTING SPRING RETURN LEVER OPERATED		400	£430.44
200.0611.63.015	HDM11S/6K03 150 A01 A01 A01 A01 A01 A01 6 BANK DOUBLE ACTING SPRING RETURN LEVER OPERATED		400	£455.63



EXCELLENT METERING!

1/2" PORTS MAX FLOW 70L/MIN MONOBLOCK HDM 18 SERIES C/W MAIN RELIEF VALVE				
PART NO	DESCRIPTION		OPERATING PRESSURE BAR	PRICE
200.0718.13.002	HDM18/1K02 150/A08 1 BANK DOUBLE ACTING SPRING RETURN LEVER OPERATED		400	£206.06
200.0718.23.001	HDM18/2K02 150/A08 A08 2 BANK DOUBLE ACTING SPRING RETURN LEVER OPERATED		400	£320.54
200.0718.33.008	HDM18/3K02 150/A08 A08 A08 3 BANK DOUBLE ACTING SPRING RETURN LEVER OPERATED		400	£446.47
200.0718.43.007	HDM18/4K02 150/A08 A08 A08 A08 4 BANK DOUBLE ACTING SPRING RETURN LEVER OPERATED		400	£544.92

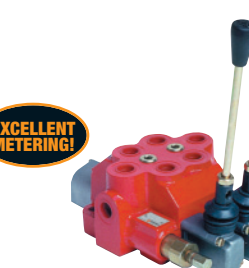

EXCELLENT METERING!

3/4" PORTS MAX FLOW 100L/MIN MONOBLOCK HDM 25 SERIES C/W MAIN RELIEF VALVE				
PART NO	DESCRIPTION		OPERATING PRESSURE BAR	PRICE
200.0725.14.001	HDM25/1K03 150/A01 L100 1 BANK DOUBLE ACTING SPRING RETURN LEVER OPERATED		320	£290.78
200.0725.24.001	HDM25/2K03 150/A01/A01 L100 2 BANK DOUBLE ACTING SPRING RETURN LEVER OPERATED		320	£522.03



EXCELLENT METERING!

3/4" PORTS MAX FLOW 160L/MIN MONOBLOCK SD18 SERIES C/W MAIN RELIEF VALVE				
PART NO	DESCRIPTION		OPERATING PRESSURE BAR	PRICE
106111001	SD18/1-P(KG3)/18L/AET 1 BANK DOUBLE ACTING SPRING RETURN LEVER OPERATED		250	£651.43
106211001	SD18/2-P(KG3)/18LX2/AET 2 BANK DOUBLE ACTING SPRING RETURN LEVER OPERATED		250	£961.30
106311001	SD18/3-P(KG3)/18LX3/AET 3 BANK DOUBLE ACTING SPRING RETURN LEVER OPERATED		250	£1,302.27
106411001	SD18/4-P(KG3)/18LX4/AET 4 BANK DOUBLE ACTING SPRING RETURN LEVER OPERATED		250	£1,595.45
106511001	SD18/5-P(KG3)/18LX5/AET 5 BANK DOUBLE ACTING SPRING RETURN LEVER OPERATED		250	£1,913.97
106611001	SD18/6-P(KG3)/18LX6/AET 6 BANK DOUBLE ACTING SPRING RETURN LEVER OPERATED		250	£2,306.00

SLICE DIRECTIONAL CONTROL VALVES TYPE HDS

System Description

The HDS valve range represents a flexible unit construction, the elements of which may be combined into one valve unit as required.

The valves are available connected in parallel and in series circuits.

A typical valve unit comprises an inlet plate, the directional control valve sections and end plate.

With all valves in neutral the flow returned to the tank (open centre). In addition high pressure carry over or closed centre circulation are available.

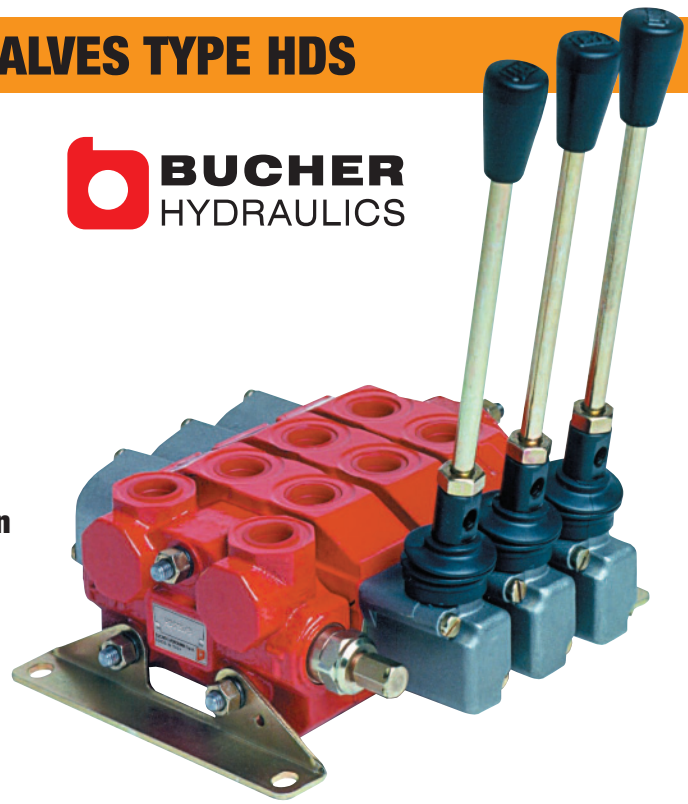

- **Lever control**
- **Electro hydraulic on/off and proportional operation**
- **Open centre, closed centre and high pressure carryover**
- **Pilot operated check valves**
- **Priority flow control valves**
- **Shock, anticavitation and combined shock and anticavitation valves**

TECHNICAL DATA		HDS 11	HDS 15	HDS 19	HDS 20	HDS 30	SD25
NUMBER OF SPOOLS		1-10	1-10	1-10	1-10	1-10	1-10
FLOW RATE	L/MIN	45	60	70	80	120	240
INLET PRESSURE MAX.	BAR	320	320	320	320	320	315
RETURN PRESSURE MAX.	BAR	30	30	30	30	30	25
FLUID		MINERAL OIL TO DIN 51524					
OPERATING TEMPERATURE	°C	-20 TO +80					
VISCOSITY RANGE	MM2/S	16-75					
FILTRATION	MICRON	≤30					
DIRECTIONAL VALVE							
CONTROLS AVAILABLE		LEVER / JOYSTICK FOR 2 VALVES / CABLE CONTROL / HYDRAULIC OR PNEUMATIC ON/OFF					
		ELECTRO HYDRAULIC (ON/OFF) / ELECTRO PNEUMATIC PROPORTIONAL					

SPOOLS AVAILABLE – PLUS MANY MORE



	A	B	C	D	E	F	G	P+T	A+B
HDS 11	40	31.8 X W + 101.6	31.8	40	171	75	122	3/8" BSP	
HDS 15	44	4 OX W + 86	40	21	179	88	115	1/2" BSP	
HDS 20	40	40 X W + 100	40	40	252	106	121	3/4" 1/2" BSP	
HDS 30	50	4 4X W + 124	44	50	262	113	126	1" 3/4"	
SD 25	N/A	6 2X W + 173	N/A	62	356	N/A	137	P 1" T 1 1/4"	1"

W = WIDTH OF DIRECTIONAL SECTIONS (MAX. 10 SECTIONS PER CONTROL BLOCK)

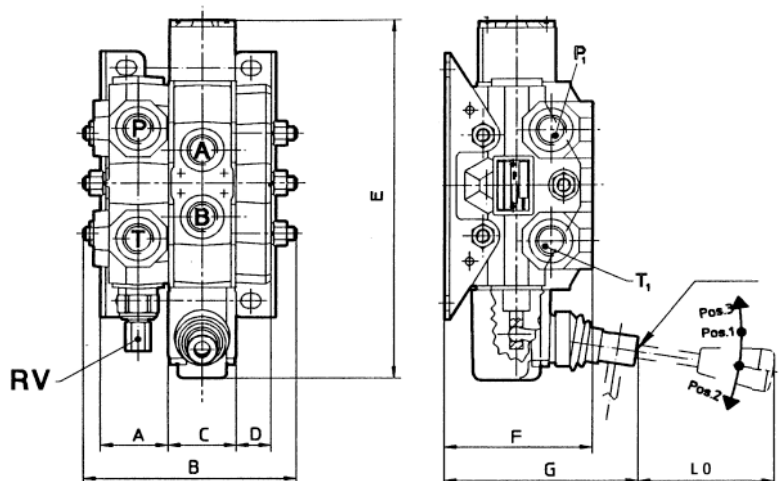
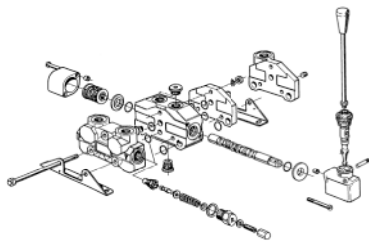

LEVER LENGTHS – mm						
HDM 140	150	200	250	300	-	-
HDS 11	150	200	150	300	-	-
HDS 15	-	185	250	300	350	-
HDS 20	-	185	250	300	350	-
HDS 30	-	185	250	300	350	-
SD25	150	200	250	300	-	-



HDS11 SLICE VALVE 3/8" PORTS MAX FLOW 45L/MIN C/W MAIN RELIEF AND MOUNTING FEET.

PART NO	DESCRIPTION		MAX FLOW L/MIN	OPERATING PRESSURE BAR	PRICE
HDS11/1/STD	1 BANK DOUBLE ACTING SPRING RETURN LEVER OPERATED		45	320	£214.75
HDS11/2/STD	2 BANK DOUBLE ACTING SPRING RETURN LEVER OPERATED		45	320	£325.71
HDS11/3/STD	3 BANK DOUBLE ACTING SPRING RETURN LEVER OPERATED		45	320	£435.26
HDS11/4/STD	4 BANK DOUBLE ACTING SPRING RETURN LEVER OPERATED		45	320	£544.79
HDS11/5/STD	5 BANK DOUBLE ACTING SPRING RETURN LEVER OPERATED		45	320	£655.77
HDS11/6 /STD	6 BANK DOUBLE ACTING SPRING RETURN LEVER OPERATED		45	320	£766.74
HDS11/7/STD	7 BANK DOUBLE ACTING SPRING RETURN LEVER OPERATED		45	320	£876.26
HDS11/8/STD	8 BANK DOUBLE ACTING SPRING RETURN LEVER OPERATED		45	320	£987.25
HDS11/9/STD	9 BANK DOUBLE ACTING SPRING RETURN LEVER OPERATED		45	320	£1,098.22
HDS11/10/STD	10 BANK DOUBLE ACTING SPRING RETURN LEVER OPERATED		45	320	£1,207.75



HDS15 SLICE VALVE 1/2" PORTS MAX FLOW 60L/MIN C/W MAIN RELIEF AND MOUNTING FEET.

PART NO	DESCRIPTION		MAX FLOW L/MIN	OPERATING PRESSURE BAR	PRICE
HDS15/1/STD	1 BANK DOUBLE ACTING SPRING RETURN LEVER OPERATED		60	320	£270.95
HDS15/2/STD	2 BANK DOUBLE ACTING SPRING RETURN LEVER OPERATED		60	320	£409.31
HDS15/3/STD	3 BANK DOUBLE ACTING SPRING RETURN LEVER OPERATED		60	320	£547.67
HDS15/4/STD	4 BANK DOUBLE ACTING SPRING RETURN LEVER OPERATED		60	320	£684.59
HDS15/5/STD	5 BANK DOUBLE ACTING SPRING RETURN LEVER OPERATED		60	320	£822.95
HDS15/6/STD	6 BANK DOUBLE ACTING SPRING RETURN LEVER OPERATED		60	320	£961.30
HDS15/7/STD	7 BANK DOUBLE ACTING SPRING RETURN LEVER OPERATED		60	320	£1,099.67
HDS15/8/STD	8 BANK DOUBLE ACTING SPRING RETURN LEVER OPERATED		60	320	£1,237.86
HDS15/9/STD	9 BANK DOUBLE ACTING SPRING RETURN LEVER OPERATED		60	320	£1,376.39
HDS15/10/STD	10 BANK DOUBLE ACTING SPRING RETURN LEVER OPERATED		60	320	£1,513.30



HDS20 SLICE VALVE 1/2" PORTS (A+B), 3/4" PORTS (P+T) MAX FLOW 80 L/MIN C/W MAIN RELIEF AND MOUNTING FEET.

PART NO	DESCRIPTION		MAX FLOW L/MIN	OPERATING PRESSURE BAR	PRICE
HDS20/1/STD	1 BANK DOUBLE ACTING SPRING RETURN LEVER OPERATED		80	320	£354.44
HDS20/2/STD	2 BANK DOUBLE ACTING SPRING RETURN LEVER OPERATED		80	320	£523.17
HDS20/3/STD	3 BANK DOUBLE ACTING SPRING RETURN LEVER OPERATED		80	320	£691.79
HDS20/4/STD	4 BANK DOUBLE ACTING SPRING RETURN LEVER OPERATED		80	320	£860.42
HDS20/5/STD	5 BANK DOUBLE ACTING SPRING RETURN LEVER OPERATED		80	320	£1,029.05
HDS20/6/STD	6 BANK DOUBLE ACTING SPRING RETURN LEVER OPERATED		80	320	£1,197.66
HDS20/7/STD	7 BANK DOUBLE ACTING SPRING RETURN LEVER OPERATED		80	320	£1,364.86
HDS20/8/STD	8 BANK DOUBLE ACTING SPRING RETURN LEVER OPERATED		80	320	£1,545.00
HDS20/9/STD	9 BANK DOUBLE ACTING SPRING RETURN LEVER OPERATED		80	320	£1,710.33
HDS20/10/STD	10 BANK DOUBLE ACTING SPRING RETURN LEVER OPERATED		80	320	£1,866.60



EXCELLENT METERING!

HDS30 SLICE VALVE 3/4" PORTS MAX FLOW 120L/MIN C/W MAIN RELIEF AND MOUNTING FEET.					
PART NO	DESCRIPTION		MAX FLOW L/MIN	OPERATING PRESSURE BAR	PRICE
HDS30/1/STD	1 BANK DOUBLE ACTING SPRING RETURN LEVER OPERATED		120	320	£469.83
HDS30/2/STD	2 BANK DOUBLE ACTING SPRING RETURN LEVER OPERATED		120	320	£662.91
HDS30/3/STD	3 BANK DOUBLE ACTING SPRING RETURN LEVER OPERATED		120	320	£860.42
HDS30/4/STD	4 BANK DOUBLE ACTING SPRING RETURN LEVER OPERATED		120	320	£1,047.78
HDS30/5/STD	5 BANK DOUBLE ACTING SPRING RETURN LEVER OPERATED		120	320	£1,245.24
HDS30/6/STD	6 BANK DOUBLE ACTING SPRING RETURN LEVER OPERATED		120	320	£1,445.58
HDS30/7/STD	7 BANK DOUBLE ACTING SPRING RETURN LEVER OPERATED		120	320	£1,627.15
HDS30/8/STD	8 BANK DOUBLE ACTING SPRING RETURN LEVER OPERATED		120	320	£1,824.60
HDS30/9/STD	9 BANK DOUBLE ACTING SPRING RETURN LEVER OPERATED		120	320	£2,011.96
HDS30/10/STD	10 BANK DOUBLE ACTING SPRING RETURN LEVER OPERATED		120	320	£2,205.10

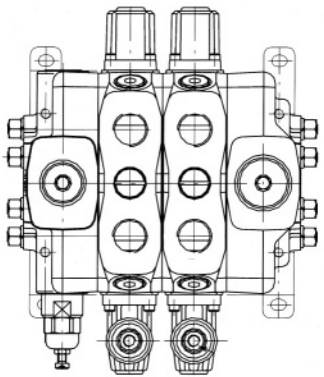

EXCELLENT METERING!

SD25 SLICE VALVE 1" PORTS MAX FLOW 240L/MIN C/W MAIN RELIEF VALVE AND MOUNTING FEET.					
PART NO	DESCRIPTION		MAX FLOW L/MIN	OPERATING PRESSURE BAR	PRICE
SD25/1/STD	1 BANK DOUBLE ACTING SPRING RETURN LEVER OPERATED		240	315	£1,337.47
SD25/2/STD	2 BANK DOUBLE ACTING SPRING RETURN LEVER OPERATED		240	315	£1,894.35
SD25/3/STD	3 BANK DOUBLE ACTING SPRING RETURN LEVER OPERATED		240	315	£2,447.22
SDS5/4/STD	4 BANK DOUBLE ACTING SPRING RETURN LEVER OPERATED		240	315	£3,009.31
SD25/5/STD	5 BANK DOUBLE ACTING SPRING RETURN LEVER OPERATED		240	315	£3,567.08
SD25/6/STD	6 BANK DOUBLE ACTING SPRING RETURN LEVER OPERATED		240	315	£4,127.72
SD25/7/STD	7 BANK DOUBLE ACTING SPRING RETURN LEVER OPERATED		240	315	£4,688.36
SD25/8/STD	8 BANK DOUBLE ACTING SPRING RETURN LEVER OPERATED		240	315	£5,249.01
SD25/9/STD	9 BANK DOUBLE ACTING SPRING RETURN LEVER OPERATED		240	315	£5,808.21
SD25/10/STD	10 BANK DOUBLE ACTING SPRING RETURN LEVER OPERATED		240	315	£6,367.41



FLOW 250 SLICE VALVE 1" SERVICE PORTS MAX FLOW 250L/MIN C/W MAIN RELIEF AND MOUNTING FEET. INLET 1 1/4" AND OUTLET 1 1/2"					
PART NO	DESCRIPTION		MAX FLOW L/MIN	OPERATING PRESSURE BAR	PRICE
FLOW250/1/STD	1 BANK DOUBLE ACTING SPRING RETURN LEVER OPERATED		250	350	£787.62
FLOW250/2/STD	2 BANK DOUBLE ACTING SPRING RETURN LEVER OPERATED		250	350	£1,110.46
FLOW250/3/STD	3 BANK DOUBLE ACTING SPRING RETURN LEVER OPERATED		250	350	£1,447.03
FLOW250/4/STD	4 BANK DOUBLE ACTING SPRING RETURN LEVER OPERATED		250	350	£1,781.31
FLOW250/5/STD	5 BANK DOUBLE ACTING SPRING RETURN LEVER OPERATED		250	350	£2,117.88
FLOW250/6/STD	6 BANK DOUBLE ACTING SPRING RETURN LEVER OPERATED		250	350	£2,454.45
FLOW250/7/STD	7 BANK DOUBLE ACTING SPRING RETURN LEVER OPERATED		250	350	£2,793.31
FLOW250/8/STD	8 BANK DOUBLE ACTING SPRING RETURN LEVER OPERATED		250	350	£3,129.88
FLOW250/9/STD	9 BANK DOUBLE ACTING SPRING RETURN LEVER OPERATED		250	350	£3,468.74
FLOW250/10/STD	10 BANK DOUBLE ACTING SPRING RETURN LEVER OPERATED		250	350	£3,805.32

ADDITIONS FOR VALVES

HANDLEVERS JUST ADD THE PRICE TO THE VALVE SELECTED



PART NO		HDM140	HDM11	HDM18	HDM25	SD18	HDS11	HDS15	HDS20	SD25	HDS30	PRICE
200.7022.1019.0	M8 X 150MM	YES	YES	NO	NO	NO	YES	NO	NO	NO	NO	£3.95
200.7022.1003.0	M8 X 200MM	YES	YES	NO	NO	NO	YES	NO	NO	NO	NO	£3.95
200.7022.1005.0	M8 X 250MM	YES	YES	NO	NO	NO	YES	NO	NO	NO	NO	£4.56
200.7022.1006.0	M8 X 300MM	YES	YES	NO	NO	NO	YES	NO	NO	NO	NO	£4.56
200.7022.2001.0	M10 X 185MM	NO	NO	YES	YES	NO	NO	YES	YES	NO	YES	£4.87
200.7022.2003.0	M10 X 250MM	NO	NO	YES	YES	NO	NO	YES	YES	NO	YES	£4.87
200.7022.2004.0	M10 X 300MM	NO	NO	YES	YES	NO	NO	YES	YES	NO	YES	£4.87
200.7022.2005.0	M10 X 350MM	NO	NO	YES	YES	NO	NO	YES	YES	NO	YES	£5.05
170013025	M12 X 250MM	NO	NO	NO	NO	YES	NO	NO	NO	YES	NO	£9.35

SPOOLS JUST ADD THE PRICE TO THE VALVE SELECTED

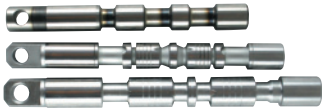

MOTOR SPOOL TYPE 'C'

DESCRIPTION	PRICE
MOTOR SPOOL TYPE 'C' FOR HDM140, HDM11, HDM18, HDM25, SD18, HDS11, HDS15, HDS20 and SD25	£30.25
MOTOR SPOOL TYPE 'J' FOR FLOW250	£119.06

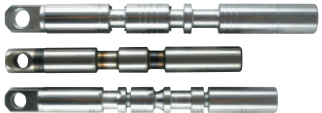

SINGLE ACTING SPOOL TYPE 'G'

DESCRIPTION	PRICE
SINGLE ACTING SPOOL TYPE 'G' FOR HDM140, HDM11, HDM18, HDM25, SD18, HDS11, HDS15, HDS20 and SD25	£30.25
SINGLE ACTING SPOOL TYPE 'T' FOR FLOW250	£119.06



4 POSITION FLOATING FOURTH 'Z' SPOOL

DESCRIPTION	PRICE
4 POSITION FLOATING FOURTH 'Z' SPOOL FOR HDM140, HDM11S and HDS11	£73.50
4 POSITION FLOATING FOURTH 'Z' SPOOL FOR HDM18 and HDS15	£86.46
4 POSITION FLOATING FOURTH 'Z' SPOOL FOR HDS20 and HDS30	£92.23
4 POSITION FLOATING FOURTH 'F' SPOOL FOR FLOW250	£119.06

VALVE CONTROL KITS JUST ADD THE PRICE TO THE VALVE SELECTED



3 POSITION DETENT KIT

DESCRIPTION	PRICE
FOR HDM140, HDM11 and HDS11	£15.85
FOR HDM18, HDM25, HDS20 and HDS30	£19.38
FOR SD18 and SD25	£43.23
FOR FLOW250	£155.69



PNEUMATIC ON-OFF

PART NO.	DESCRIPTION	PRICE
200.9686.5049.0	FOR HDM140, HDM11S and HDS11	£118.18
200.9686.5011.0	FOR HDM18/HDS15	£121.06
200.9686.5013.0	FOR HDM25/HDS20/HDS30	£123.61
	FOR FLOW250	POA



PNEUMATIC PROPORTIONAL CONTROL

PART NO.	DESCRIPTION	PRICE
200.9686.5009.0	FOR HDM18 and HDS15	£133.93
200.9686.5010.0	FOR HDM25/HDS20/HDS30	£146.50
	FOR FLOW250	POA



ELECTRO-PNEUMATIC ON-OFF

PART NO.	DESCRIPTION	PRICE
200.9686.6023.0	12VDC FOR HDM18/HDS15	£410.61
200.9686.6026.0	24VDC FOR HDM18/HDS15	£410.61
200.9686.6024.0	12VDC FOR HDM25/HDS20/HDS30	£410.61
200.9686.6027.0	24VDC FOR HDM25 HDS20/HDS30	£410.61
	FOR FLOW250	POA

ADDITIONS FOR VALVES



HYDRAULIC ON-OFF VALVE

PART NO.	DESCRIPTION	PRICE
200.9686.5049.0	FOR HDM140/HDM11S/HDS11	£117.61
200.9686.5011.0	FOR HDM18/HDS15	£121.11
200.9686.5013.0	FOR HDM25,HDS20/HDS30	£123.61
	FOR FLOW250	POA



HYDRAULIC PROPORTIONAL VALVE

PART NO.	DESCRIPTION	PRICE
200.9686.5019.0	FOR HDM18/HDS15	£105.06
200.9686.5020.0	FOR HDM25 AND HDS20	£112.08
200.9686.5017.0	FOR HDS30	£111.86
	FOR FLOW250	POA

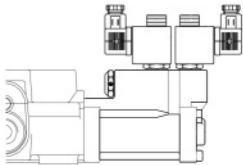

ELECTRO-HYDRAULIC ON-OFF INTERNAL PILOT VERSION VALVE

PART NO.	DESCRIPTION	PRICE
200.9686.6038.0	FOR HDM18/HDS15	£505.54
200.9686.6039.0	FOR HDS20/HDS30	£505.54

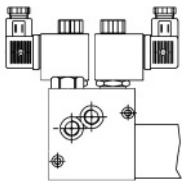

ELECTRO-HYDRAULIC ON-OFF EXTERNAL PILOT VERSION VALVE

PART NO.	DESCRIPTION	PRICE
200.9686.6031.0	FOR HDM18/HDS15	£639.65
200.9686.6032.0	FOR HDS20/HDS30	£639.65
200.9686.6051.0	FOR HDM25	£639.65



ELECTRO MAGNETIC ON-OFF VALVE

PART NO.	DESCRIPTION	PRICE
200.9686.1179.0	12VDC FOR HDM18 AND HDS15	£381.71
200.9686.1180.0	24VDC FOR HDM18 AND HDS15	£381.71



ELECTRO MAGNETIC ON-OFF VALVE

DESCRIPTION	PRICE
FOR HDS11	£200.90
FOR HDS15	£200.90

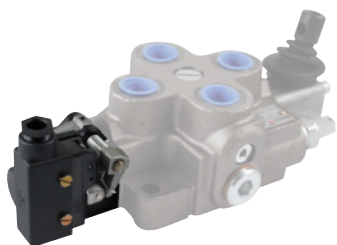

MICROSWITCH KITS FOR VALVES

DESCRIPTION	PRICE
200.9686.1064.0 Assembly for HDM140, HDM11 AND HDS11	£52.08
200.9686.1065.0 Assembly for HDM18 and HDS15	£64.10
200.9686.1054.0 Assembly for HDS20 and HDS30	£108.16

DESCRIPTION	PRICE
200.9625.0001.0 Microswitch only for HDM18, HDS15, HDS20 and HDS30	£46.06
200.9625.0006.0 Microswitch only for HDM11 and HDS11	£39.05

MISCELLANEOUS ADD-ONS JUST ADD THE PRICE TO THE VALVE SELECTED

FLOWFIT

BUCHER HYDRAULICS



HIGH PRESSURE CARRYOVER CONNECTOR (ADD ON PER VALVE)

DESCRIPTION	PRICE
HDM11	£12.50
HDM18	£20.35
HDM25	£21.26
SD18	£26.81
HDS11	£12.50
HDS15	£20.35
HDS20	£21.24
HDS30	£22.56
SD25	£27.84
FLOW250	£28.16

NOTE: HDM140 NOT AVAILABLE

ADDITIONS FOR VALVES



CLOSED CENTRE VALVE SOLUTIONS (ADD ON PER VALVE)

DESCRIPTION	PRICE
HDM140	£7.61
HDM11	£7.61
HDM18	£18.30
HDM25	£18.30
SD18	£22.67
HDS11	£7.61
HDS15	£18.34
HDS20	£19.18
HDS30	£20.50
SD25	£17.33
FLOW250	£17.33



RELIEF VALVE BLANKING PLUG

DESCRIPTION	PRICE
RELIEF BLANKING PLUG FOR HDM140, HDM11, HDM18, HDM25, SD18, HDS11, HDS15, HDS20, HDS30 and SD25	£18.36
FLOW250	£18.32



REMOTE CABLE ASSEMBLY

DESCRIPTION	PRICE
1 METRE CABLE ASSEMBLY	£134.60
1.5 METRE CABLE ASSEMBLY	£142.37
2.5 METRE CABLE ASSEMBLY	£150.63
4 METRE CABLE ASSEMBLY	£167.13
5 METRE CABLE ASSEMBLY	£185.71
FLOW250	POA

SUITS ALL VALVES EXCEPT SD18/SD25



JOYSTICK ASSEMBLY

DESCRIPTION	PRICE
JOYSTICK ASSEMBLY FOR HDM11, HDM18, HDM25, HDS11, HDS15, HDS20 and HDS30	£142.37
FLOW250	POA

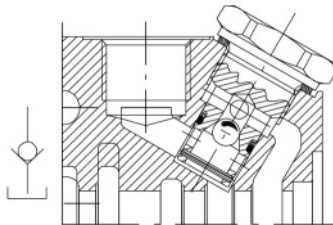

ANTI-CAVITATION VALVES TYPE 'C' C/A OR C C/AB

DESCRIPTION	PRICE
C/A OR B FOR HDS11	£28.77
C/AB FOR HDS11	£37.67
C/A OR B FOR HDS15	£42.33
C/AB FOR HDS15	£55.60
C/A OR B FOR HDS20/HDS30	£58.98



ANTI-SHOCK AND ANTI-CAVITATION VALVES TYPE 'UC' UC/A UCAB

DESCRIPTION	PRICE
UC/A OR B FOR HDS11	£60.55
UC/AB FOR HDS11	£88.99
UC/A OR B FOR HDS15	£66.73
UC/AB FOR HDS15	£117.42
UC/A OR B FOR HDS20/HDS30	£126.04
UC/AB FOR HDS20/HDS30	£171.19
EK20KOI FOR FLOW250	£91.58



ANTI-SHOCK VALVES TYPE 'OA' OA/A OR B OAAB

DESCRIPTION	PRICE
OA/A OR B FOR HDS11	£55.60
OA/AB FOR HDS11	£73.52
OA/A OR B FOR HDS15	£67.35
OA/AB FOR HDS15	£92.71
OA/A OR B FOR HDS20/HDS30	£75.45
OA/AB FOR HDS20/HDS30	£99.52

FLOWFIT's extensive product range includes three types of diverter valves. DF and DH versions are available with manual and mechanical controls, whilst the DFE versions are solenoid operated.

SOLENOID DIVERTER VALVES



Diverter valves are an added extra facility to the directional control valve when it is needed for a sequence of operations, such as a safety operation or to control a selected actuator.

3 WAY SOLENOID DIVERTER VALVES

PART NUMBER	PORT SIZE BSP	TYPE	VOLTAGE	NOMINAL FLOW L/MIN	MAX PRESSURE STANDARD (BAR)	MAX PRESSURE WITH DRAIN (BAR)	WEIGHT (KG)	PRICE
12A240020	3/8"	DFE052	12V DC	30	160	250	1.6	£295.06
12A240040	3/8"	DFE052	24V DC	30	160	250	1.6	£295.06
12A440013	1/2"	DFE10	12V DC	60	160	250	2.9	£388.67
12A440025	1/2"	DFE10	24V DC	60	160	250	2.9	£388.91
12A640014	3/4"	DFE20	12V DC	110	160	250	4.2	£526.79
12A640026	3/4"	DFE20	24V DC	110	160	250	4.2	£526.79

6 WAY SOLENOID DIVERTER VALVES



DFE10
6 WAY • 1/2" BSP

PART NUMBER	PORT SIZE BSP	TYPE	VOLTAGE	NOMINAL FLOW L/MIN	MAX PRESSURE STANDARD (BAR)	MAX PRESSURE WITH DRAIN (BAR)	WEIGHT (KG)	PRICE
12A270033	3/8"	DFE052	12V DC	30	160	250	2	£334.68
12A270023	3/8"	DFE052	24V DC	30	160	250	2	£334.68
12A470013	1/2"	DFE10	12V DC	60	160	250	3.7	£410.25
12A470025	1/2"	DFE10	24V DC	60	160	250	3.7	£410.25
12A670014	3/4"	DFE20	12V DC	110	160	250	6.3	£577.56
12A670026	3/4"	DFE20	24V DC	110	160	250	6.3	£577.56

OPTIONAL EXTRAS

* Connect to tank to give max. pressure of 250 bar.

PART NUMBER	DESCRIPTION	PRICE
2X1001010	TYPE CO2 (ISO4400) 12/24V DC HERSCHMANN CONNECTOR	£5.17
5GIU001	DRAIN CONNECTOR TO SUIT DFE052	£16.88
5GIU004	DRAIN CONNECTOR TO SUIT DFE10	£19.66
5GIU007	DRAIN CONNECTOR TO SUIT DFE20	£23.88

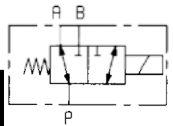

3 way

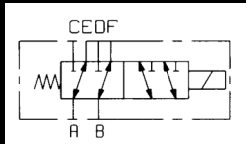

6 way

LEVER OPERATED DIVERTER VALVES 'DF' SERIES



DF5/3A/17L



DF5/6A/17L

PART NUMBER	DESCRIPTION - LEVER OPERATED	PORT SIZE BSP	FLOW RATE L/MIN	MAX. PRESS. BAR	PRICE
122052040	DF5/3A/12/L 3 PORT 2 POSITION DETENT	3/8"	60	315	£195.81
122054040	DF5/3A/17/L 3 PORT 2 POSITION SPRING CONTROL BIAS TO 'A' PORT	3/8"	60	315	£174.67
124052040	DF10/3A/12/L 3 PORT 2 POSITION DETENT	1/2"	90	315	£257.93
124054040	DF10/3A/17/L 3 PORT 2 POSITION SPRING CONTROL BIAS TO 'A' PORT	1/2"	90	315	£234.98
126052040	DF20/3A/12/L 3 PORT 2 POSITION DETENT	3/4"	140	315	£363.30
126054040	DF20/3A/17/L 3 PORT 2 POSITION SPRING CONTROL BIAS TO 'A' PORT	3/4"	140	315	£334.95
127052040	DF25/3A/12/L 3 PORT 2 POSITION DETENT	1"	280	315	£567.24
127054040	DF25/3A/17/L 3 PORT 2 POSITION SPRING CONTROL BIAS TO 'A' PORT	1"	280	315	£532.12
122082040	DF5/6A/12/L 6 PORT 2 POSITION DETENT	3/8"	60	315	£229.60
122084040	DF5/6A/17/L 6 PORT 2 POSITION SPRING CONTROL BIAS TO 'A' PORT	3/8"	60	315	£213.37
124082040	DF10/6A/12/L 6 PORT 2 POSITION DETENT	1/2"	90	315	£295.77
124084040	DF10/6A/17/L 6 PORT 2 POSITION SPRING CONTROL BIAS TO 'A' PORT	1/2"	90	315	£272.79
126082040	DF20/6A/12/L 6 PORT 2 POSITION DETENT	3/4"	140	315	£403.82
126084040	DF20/6A/17/L 6 PORT 2 POSITION SPRING CONTROL BIAS TO 'A' PORT	3/4"	140	315	£375.45